

The logo for Precision Instruments Corp is a horizontal bar divided into two sections. The left section is orange and the right section is black. The text "Precision Instruments Corp" is written in white, sans-serif font across the bar.

Precision Instruments Corp

Surgical Instruments

# Arterienklemmen

## Artery Forceps

### Pinzas hemostaticas



Halsted-Mosquito

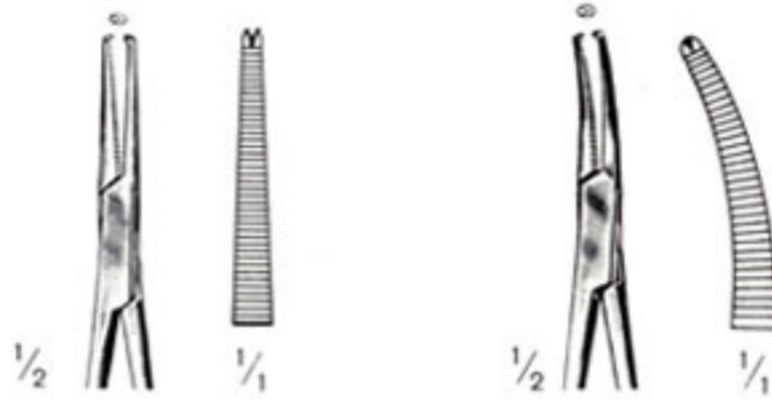

Halsted-Mosquito

gerade straight rectas	1 : 2		gebogen curved curvas
	cm	in.	
1-312-12	12,5	5	1-313-12
1-312-14	14,0	5½	1-313-14



1-314-15  
15 cm / 6"

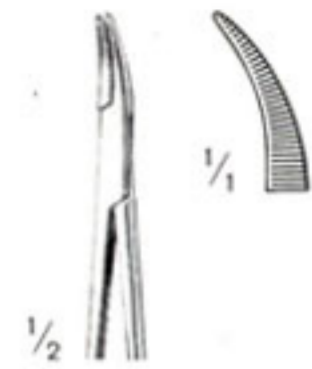

1-315-15  
15 cm / 6"

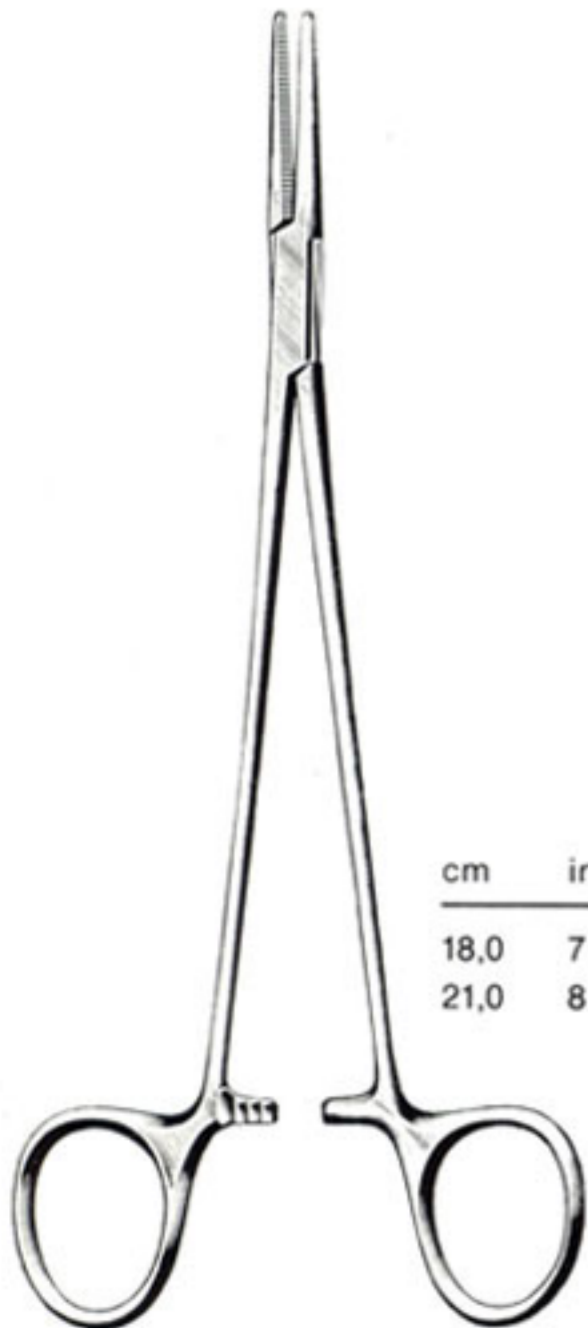

Halsted-Mosquito

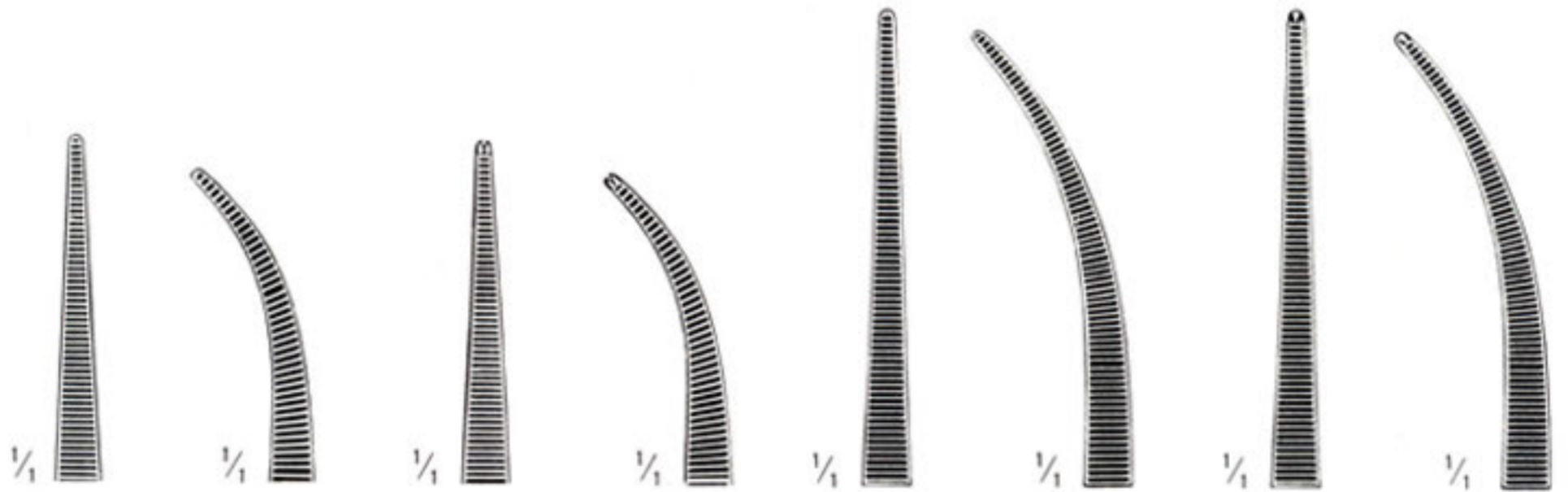

cm	in.	gerade straight rectas	gebogen curved curvas	gerade straight rectas	gebogen curved curvas	gerade straight rectas	gebogen curved curvas	gerade straight rectas	gebogen curved curvas
18,0	7	1-316-18	1-317-18	1-318-18	1-319-18	1-316-21	1-317-21	1-318-21	1-319-21
21,0	8¼								

# Arterienklemmen

## Artery Forceps

### Pinzas hemostaticas

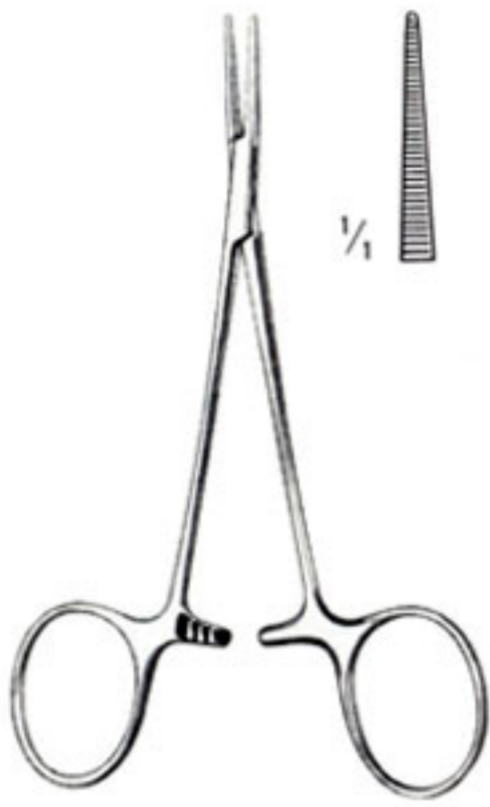

Micro-Mosquito

1-320-10 = 10 cm / 4"

1-320-12 = 12 cm / 4 3/4"

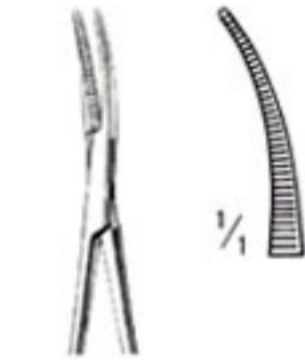

Micro-Mosquito

1-321-10 = 10 cm / 4"

1-321-12 = 12 cm / 4 3/4"

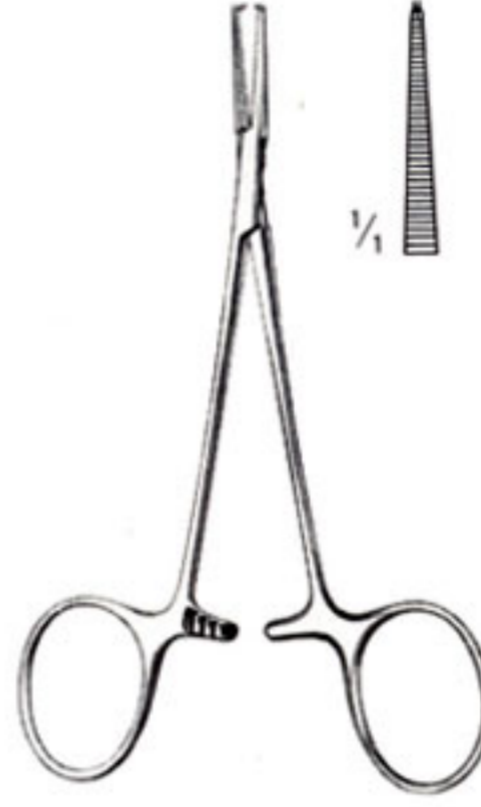

Micro-Mosquito

1-322-10 = 10 cm / 4"

1-322-12 = 12 cm / 4 3/4"

1:2 Zähne · Teeth · Dientes

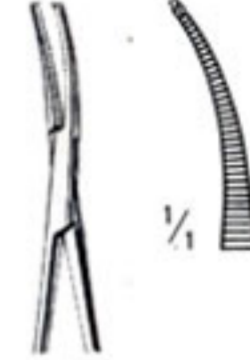

Micro-Mosquito

1-323-10 = 10 cm / 4"

1-323-12 = 12 cm / 4 3/4"

1:2 Zähne · Teeth · Dientes



1-324-14

Providence-Hospital

14 cm / 5 1/2"

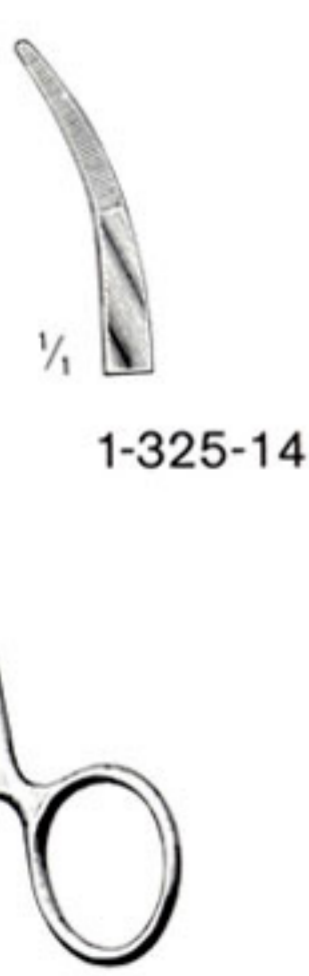

1-325-14

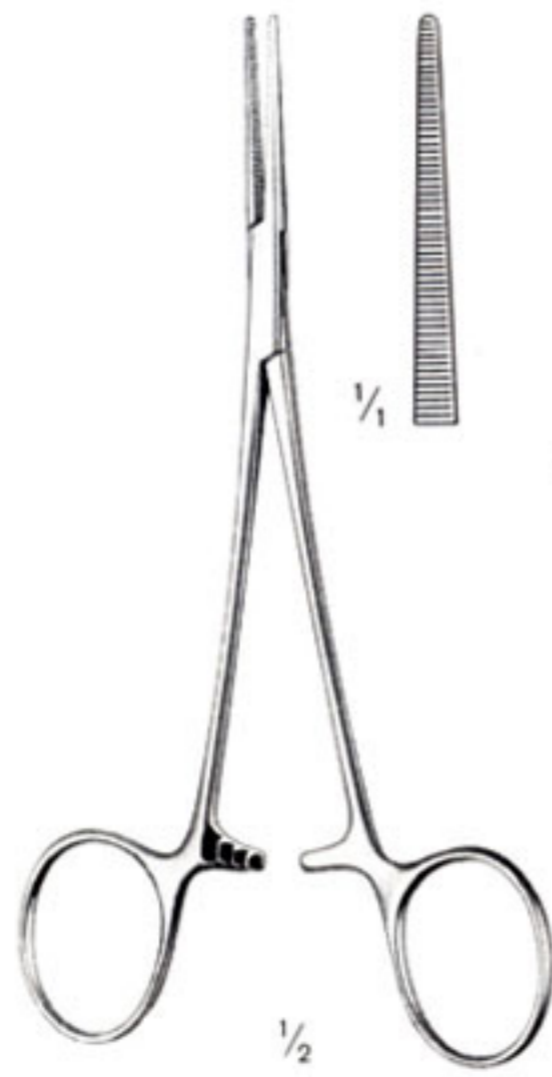

Leriche

1-326-15

15 cm / 6"



1-327-15

15 cm / 6"

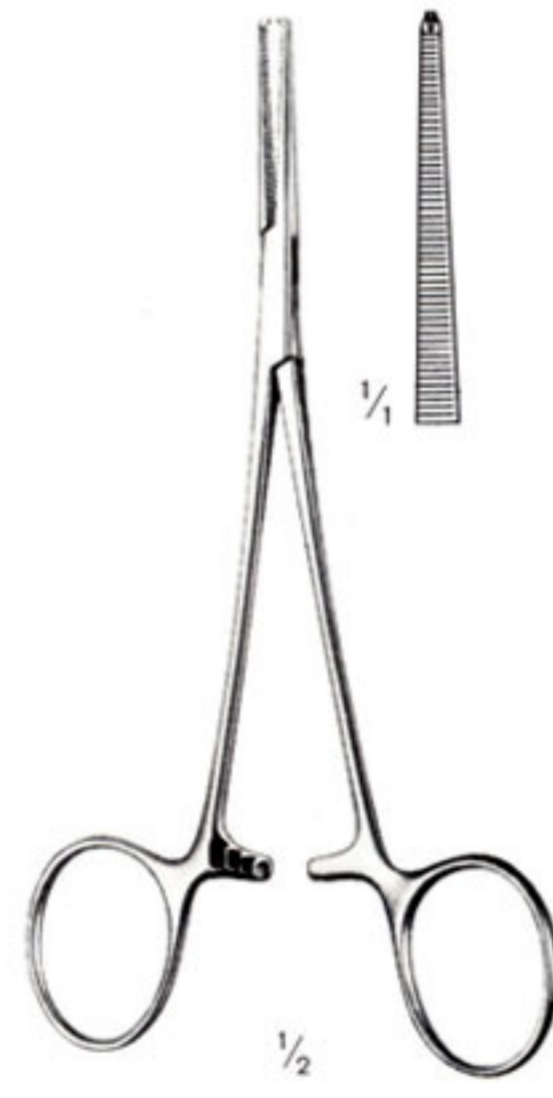

Leriche

1-328-15

15 cm / 6"

1:2 Zähne · Teeth · Dientes

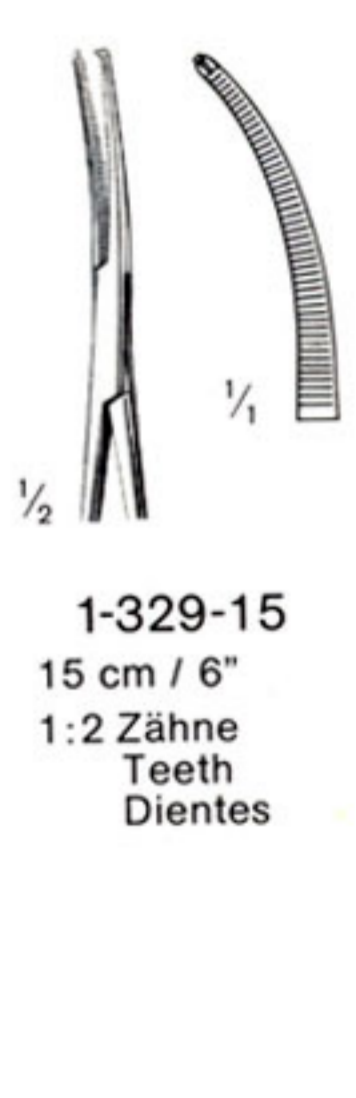

1-329-15

15 cm / 6"

1:2 Zähne

Teeth

Dientes

# Arterienklemmen

## Artery Forceps

### Pinzas hemostaticas

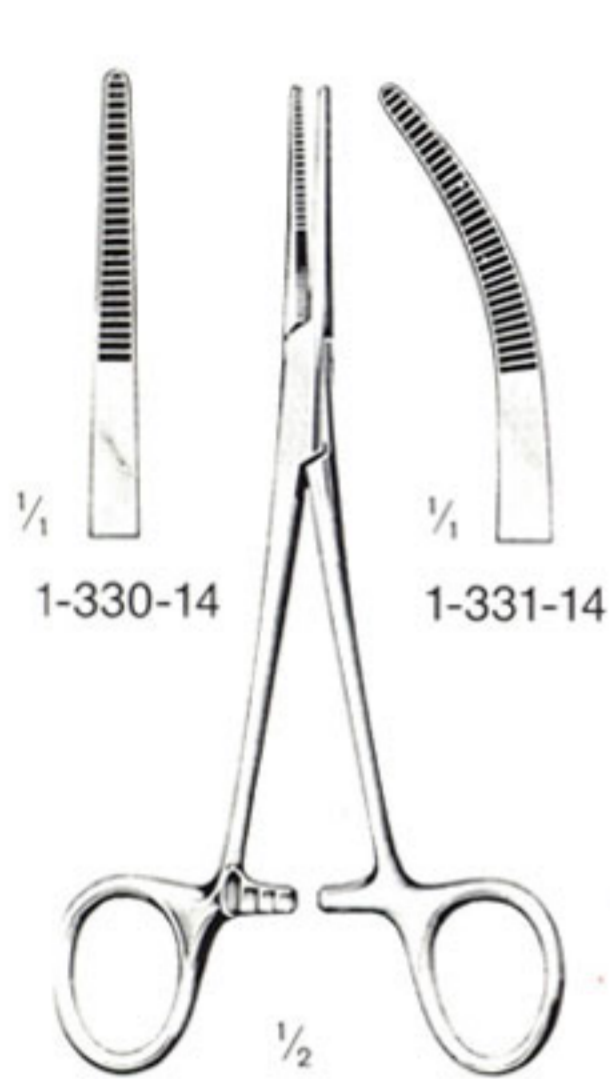

Kelly  
14 cm / 5 1/2"

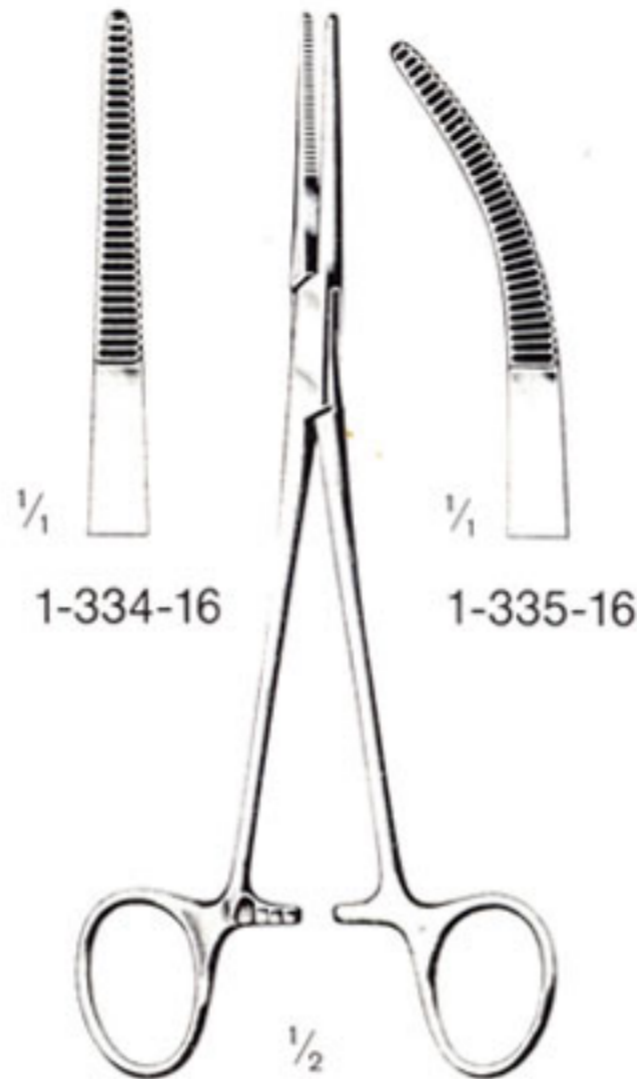

Kelly-Rankin  
16 cm / 6 1/4"

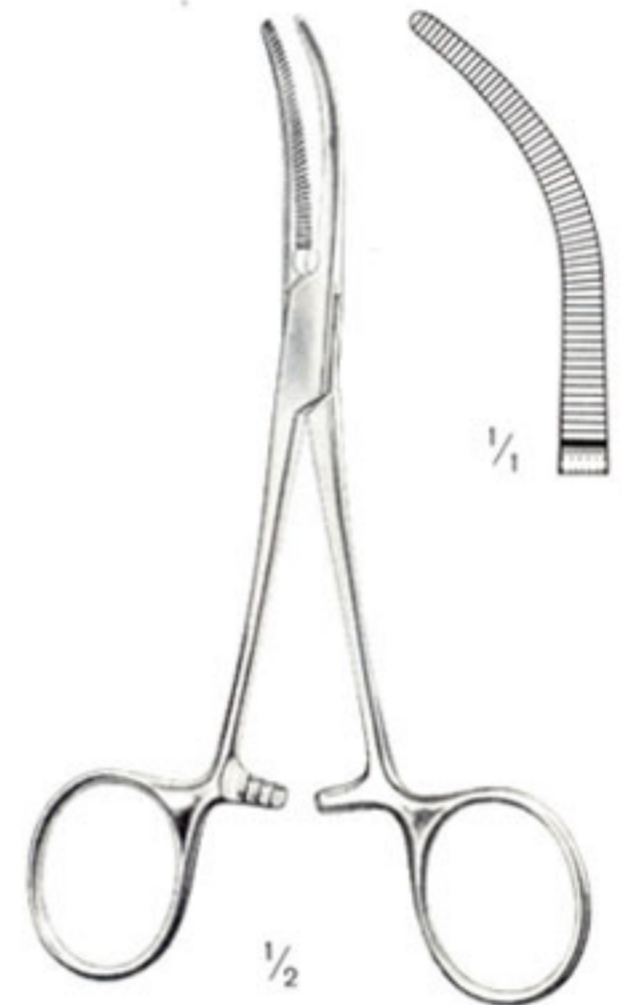

Baby-Overholt  
1-339-14  
13,5 cm / 5 1/4"

Maul kreuzgerieft  
cross serrations  
bocas con estrías cruzadas

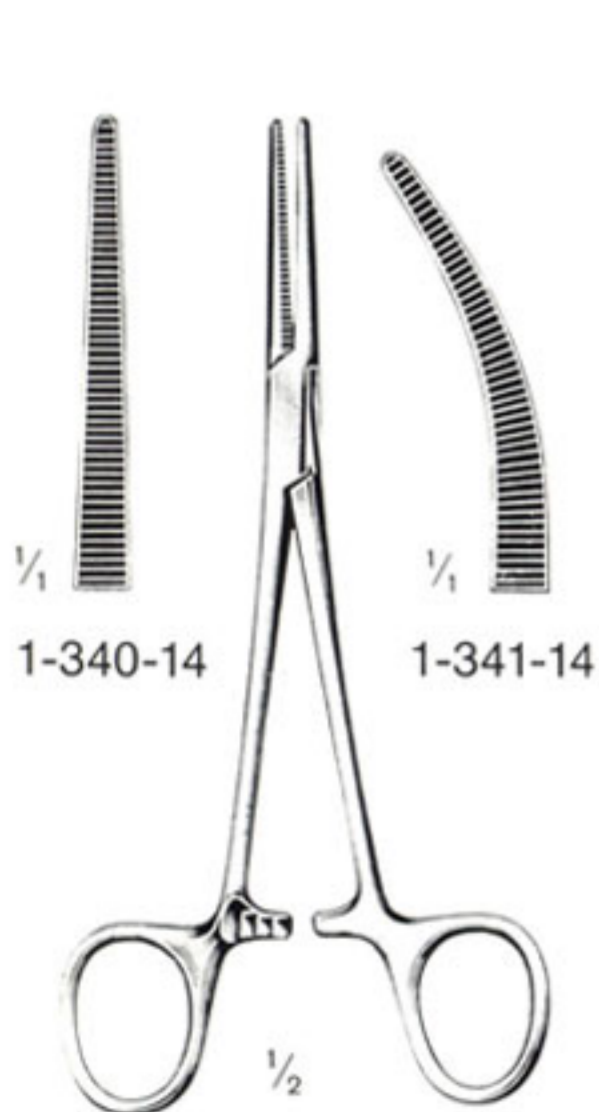

Crile  
14 cm / 5 1/2"

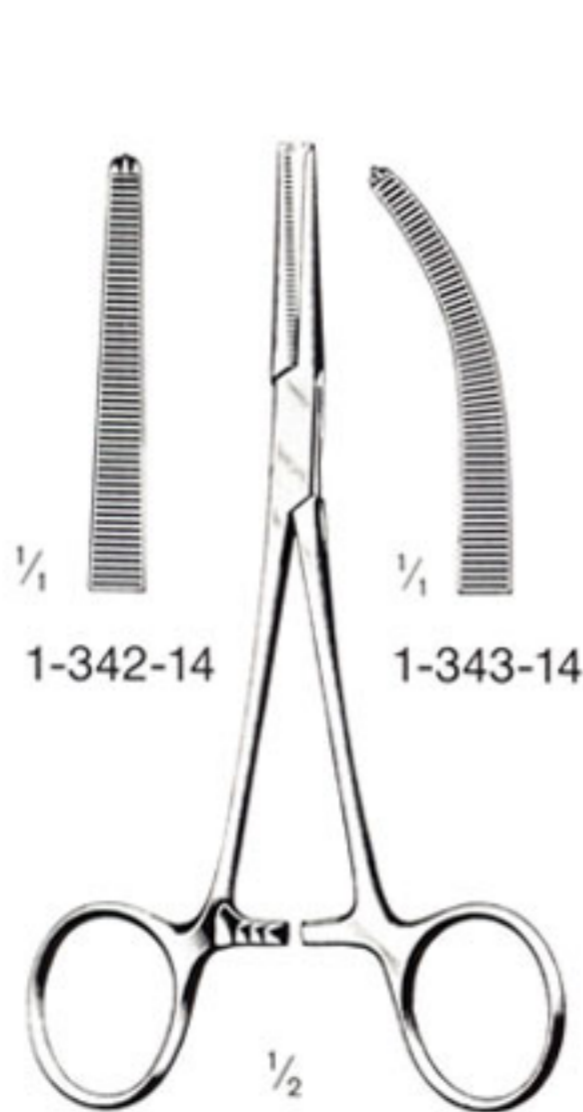

Crile  
14 cm / 5 1/2"  
1 : 2

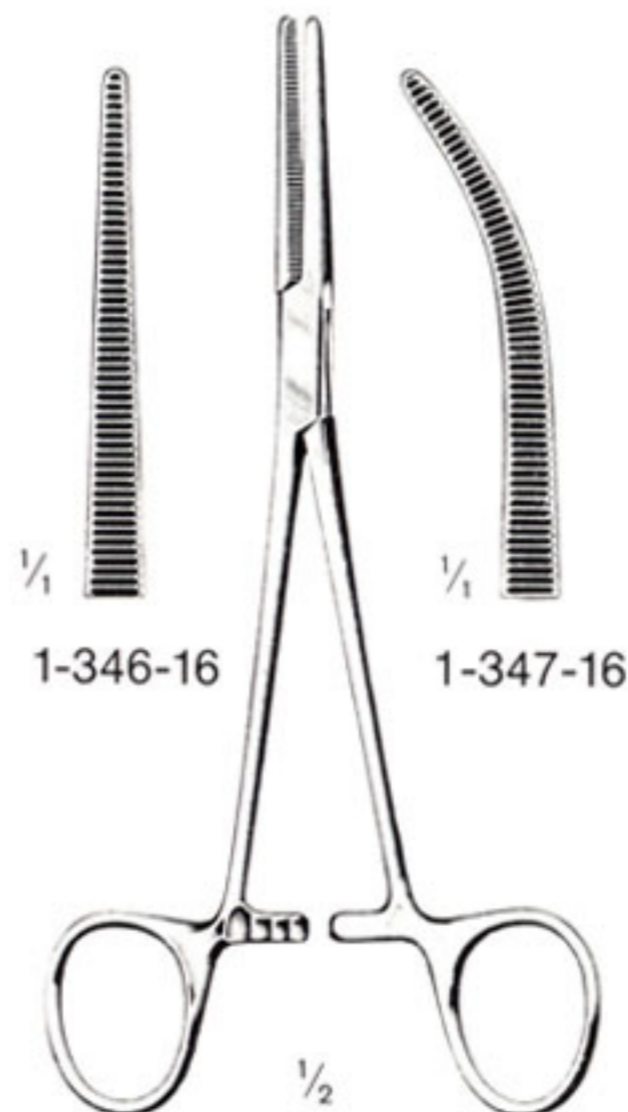

Crile-Rankin  
16 cm / 6 1/4"

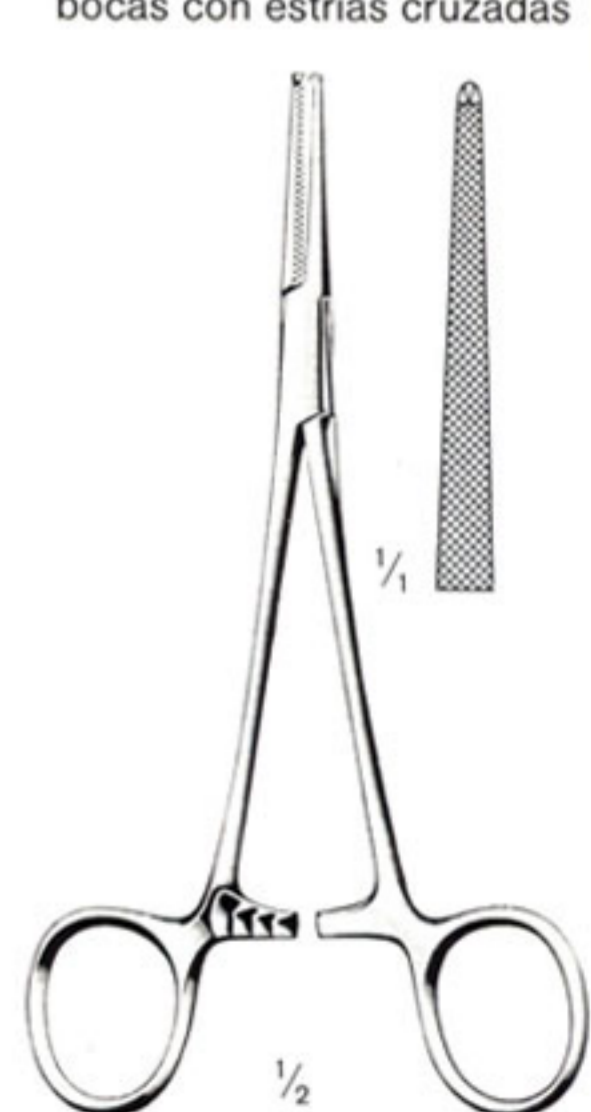

Lovlace  
1-350-15  
15,5 cm / 6"  
1 : 2

# Arterienklemmen

## Artery Forceps

### Pinzas hemostaticas

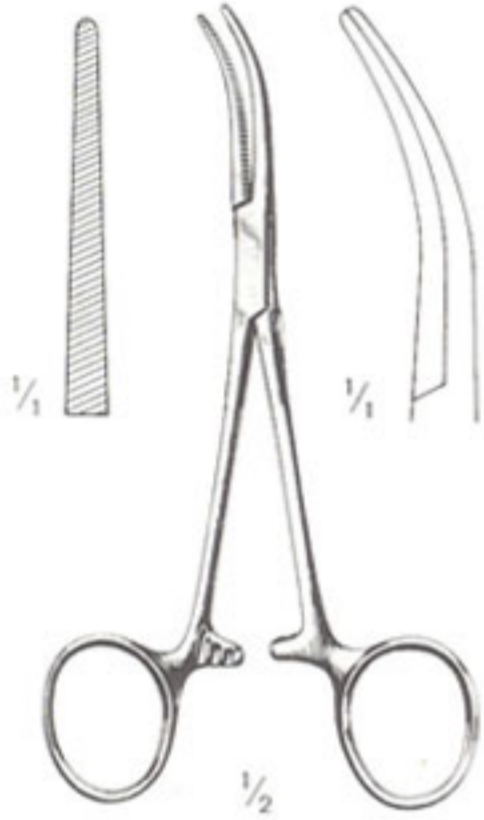

Mosquito-Dandy  
1-351-12  
12 cm / 4 3/4"

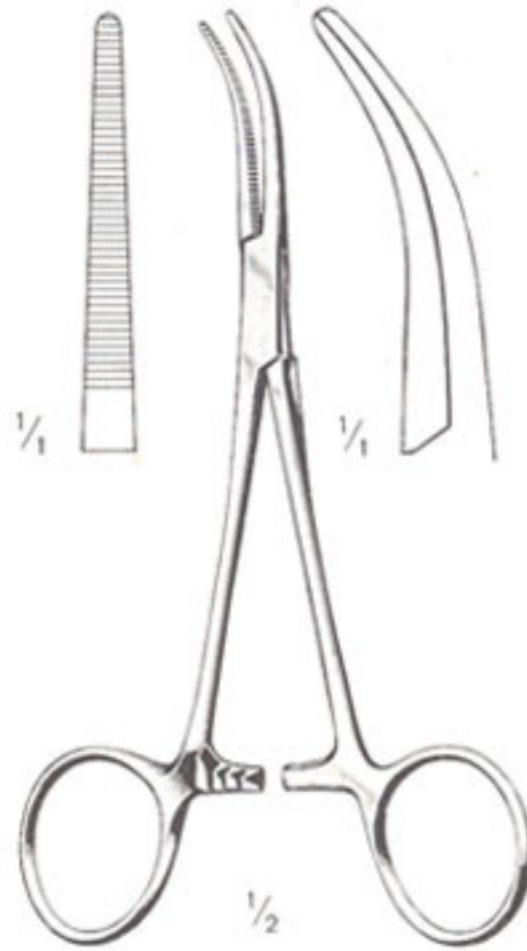

Dandy  
1-355-14  
14 cm / 5 1/2"

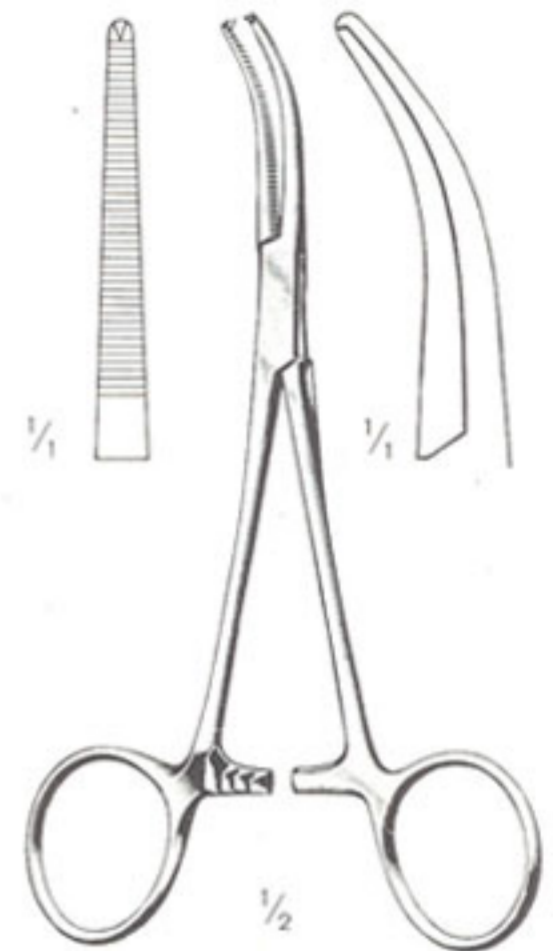

Dandy  
1-357-14  
1 : 2 Zähne · Teeth · Dientes

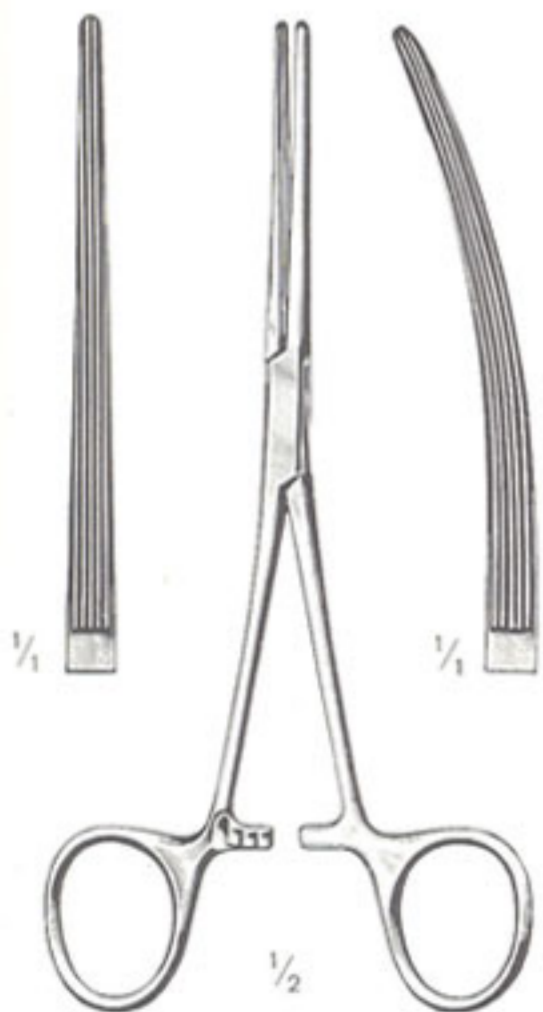

Bainbridge

gerade straight rectas	cm	in.	gebogen curved curvas
1-358-15	15,0	6	1-359-15
1-358-18	18,5	7 1/4	1-359-18



Schnidt  
19 cm / 7 1/2"

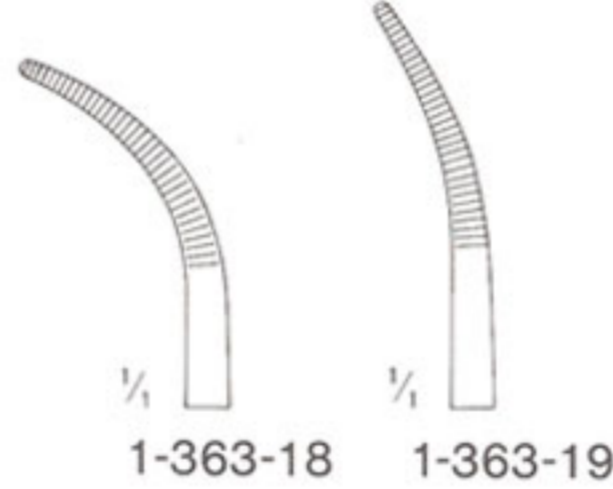

1-363-18

1-363-19

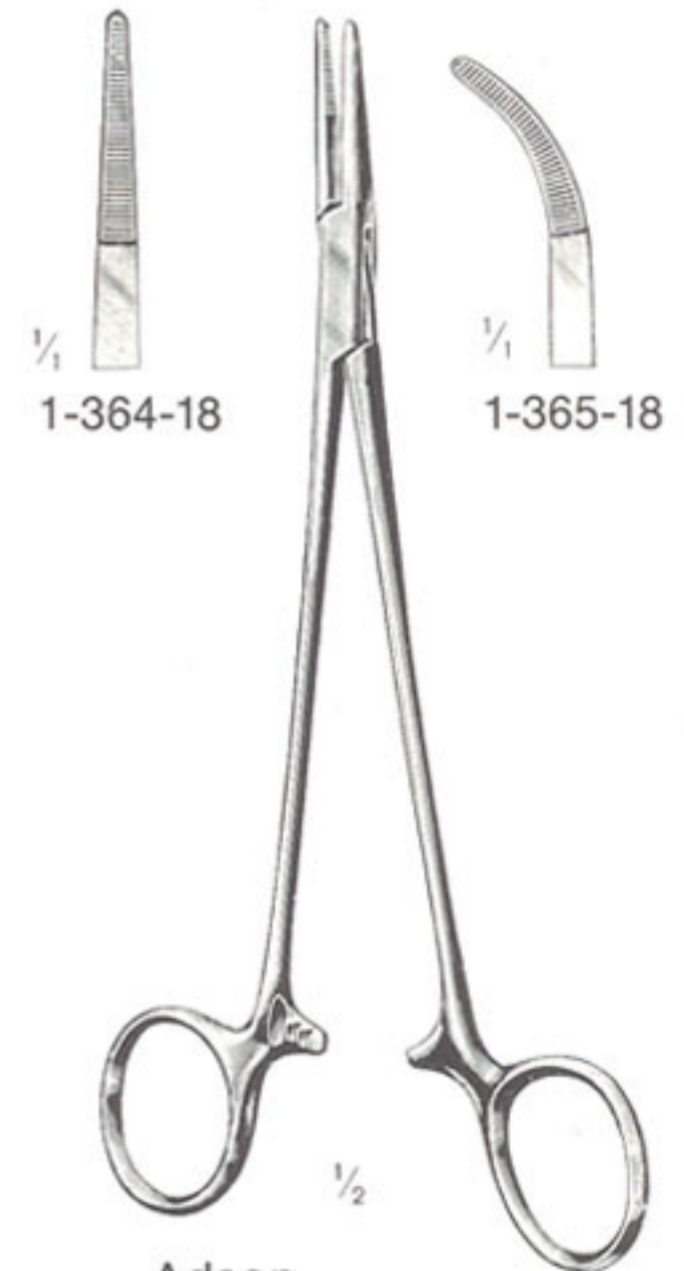

Adson  
18,5 cm / 7 1/4"

# Arterienklemmen

## Artery Forceps

### Pinzas hemostaticas

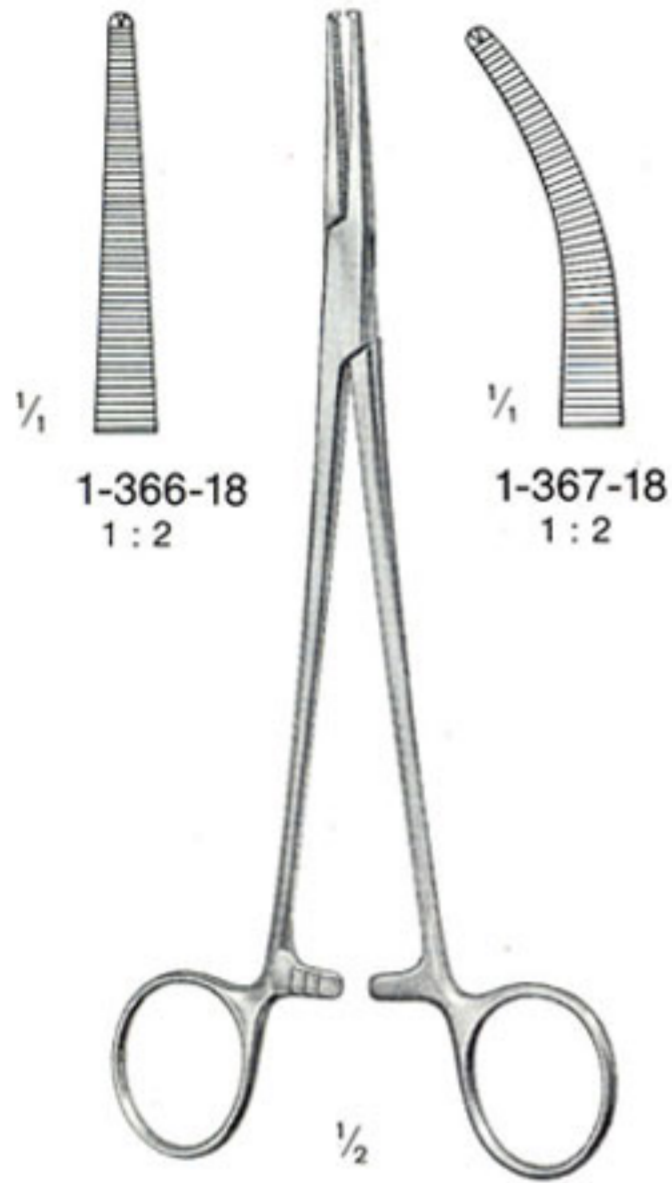

**Adson**  
18,5 cm / 7 1/4"

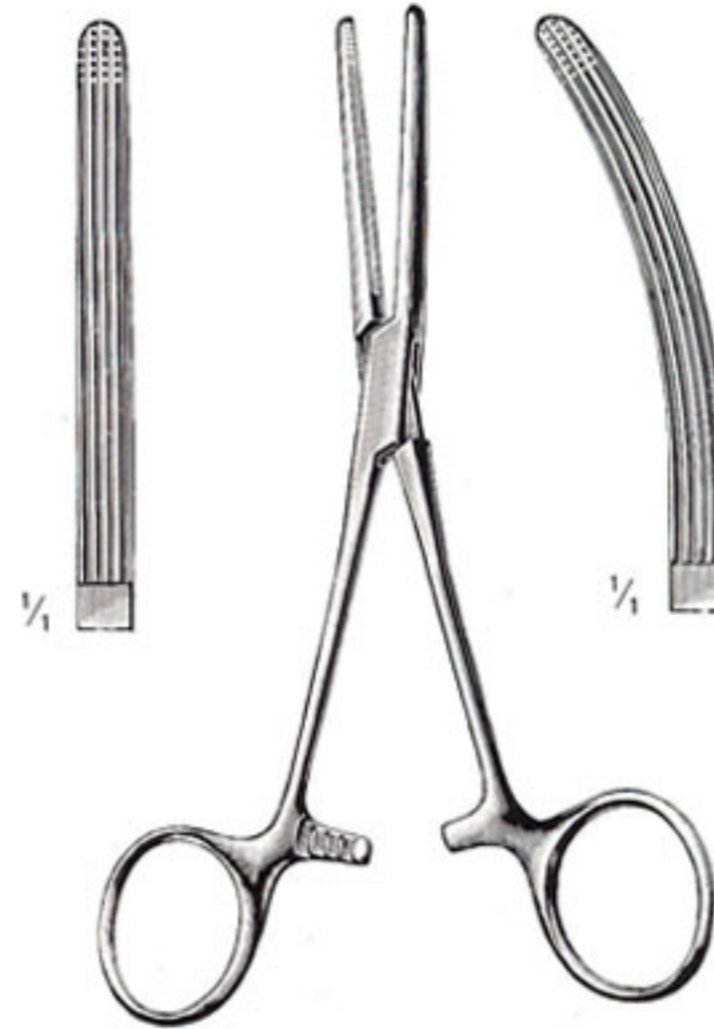

**Rochester-Carmalt**

straight rectas	cm	in.	curved curvas
1-370-16	16	6 1/4	1-371-16
1-370-20	20	8	1-371-20



**Péan**

straight rectas	cm	in.	curved curvas
1-374-13	13	5	1-375-13
1-374-14	14	5 1/2	1-375-14
1-374-16	16	6 1/4	1-375-16

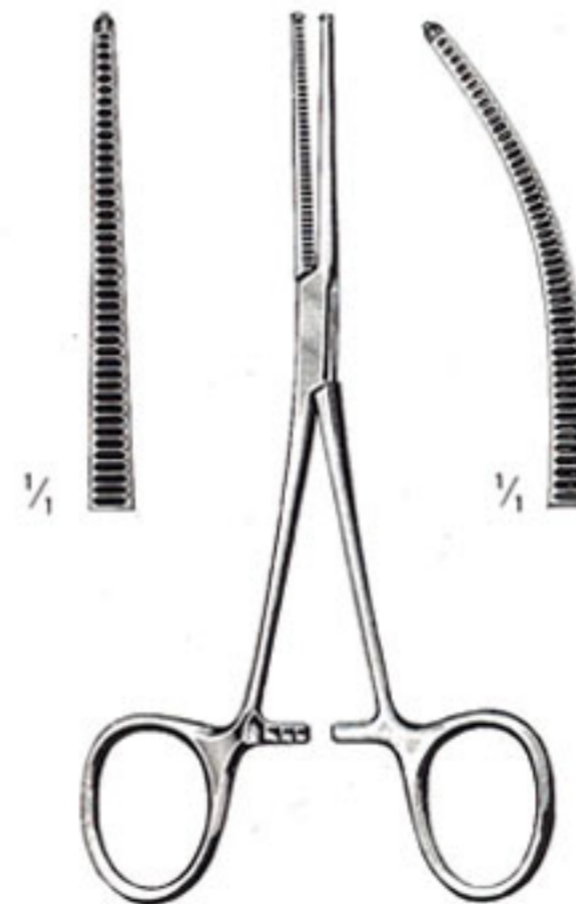

**Kocher**

straight rectas	1:2 cm	in.	curved curvas
1-384-13	13	5	1-385-13
1-384-14	14	5 1/2	1-385-14
1-384-16	16	6 1/4	1-385-16

# Arterienklemmen

## Artery Forceps

### Pinzas hemostaticas

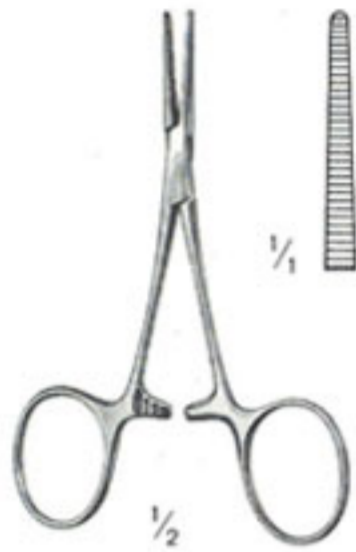

Carrel  
1-150-08  
8,5 cm / 3 1/2"



Terrier  
1-154-08  
8,5 cm / 3 1/2"

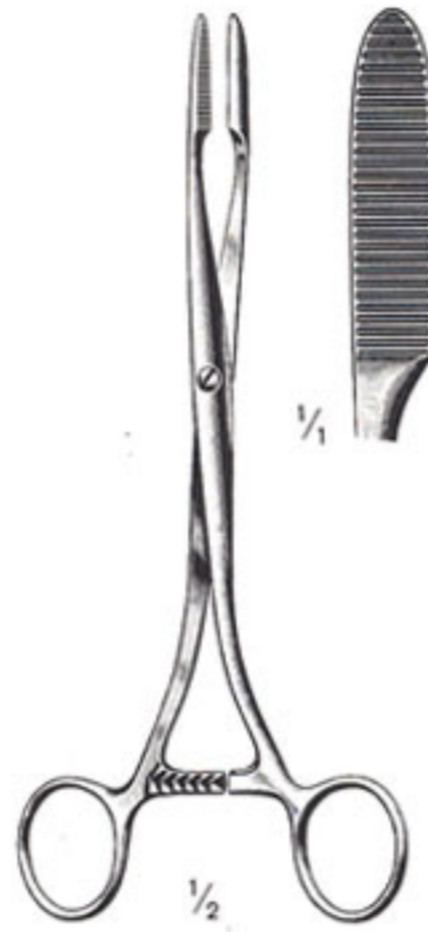

Péan

straight rectas	cm	in.
1-174-18	18,0	7
1-174-20	20,0	8

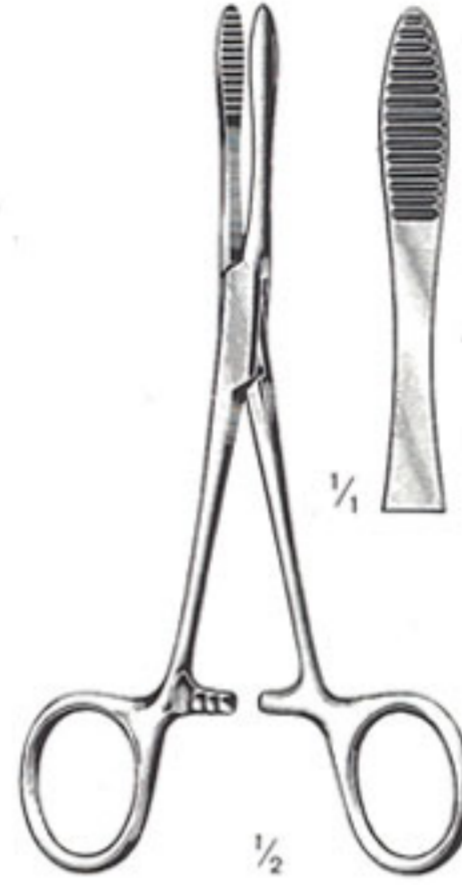

Péan

14 cm / 5 1/2" = 1-176-14  
16 cm / 6 1/4" = 1-176-16

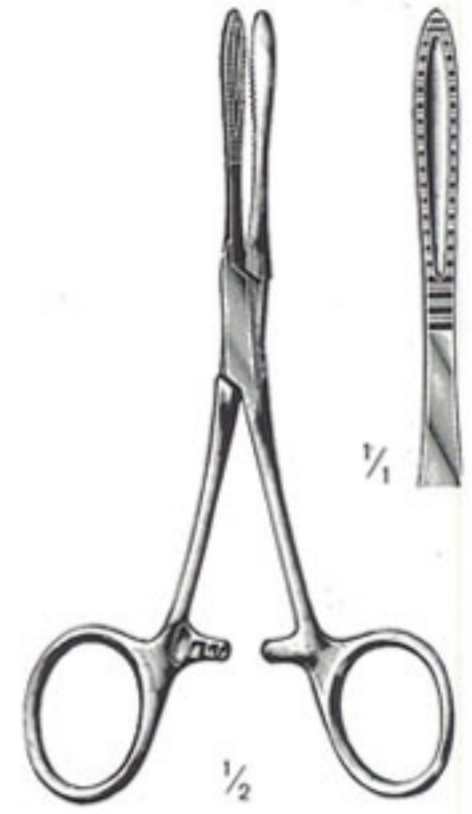

Kroenlein  
1-182-13  
13 cm / 5"



Péan



straight rectas	cm	in.	curved curvas
1-200-18	18	7	1-201-18
1-200-20	20	8	1-201-20
1-200-22	22	8 3/4	1-201-22
1-200-24	24	9 1/2	1-201-24
1-200-26	26	10 1/4	1-201-26
1-200-28	28	11	1-201-28

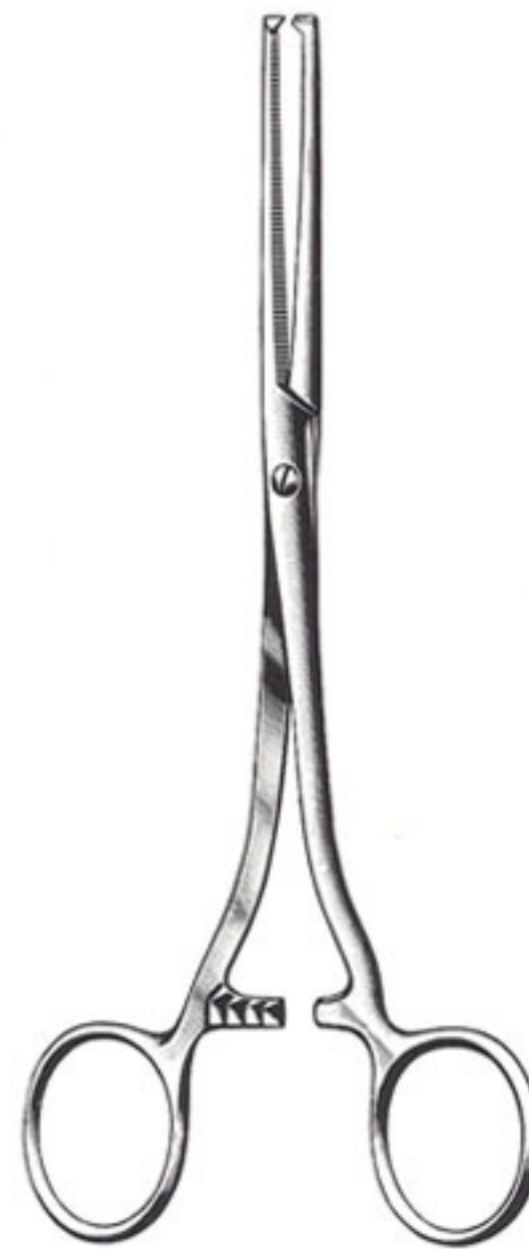

Kocher



straight rectas	cm	in.	curved curvas
1-220-18	18,0	7	1-221-18
1-220-20	20,0	8	1-221-20
1-220-22	22,0	8 3/4	1-221-22
1-220-24	24,0	9 1/2	1-221-24
1-220-26	26,0	10 1/4	1-221-26

# Arterienklemmen

## Artery Forceps

### Pinzas hemostaticas

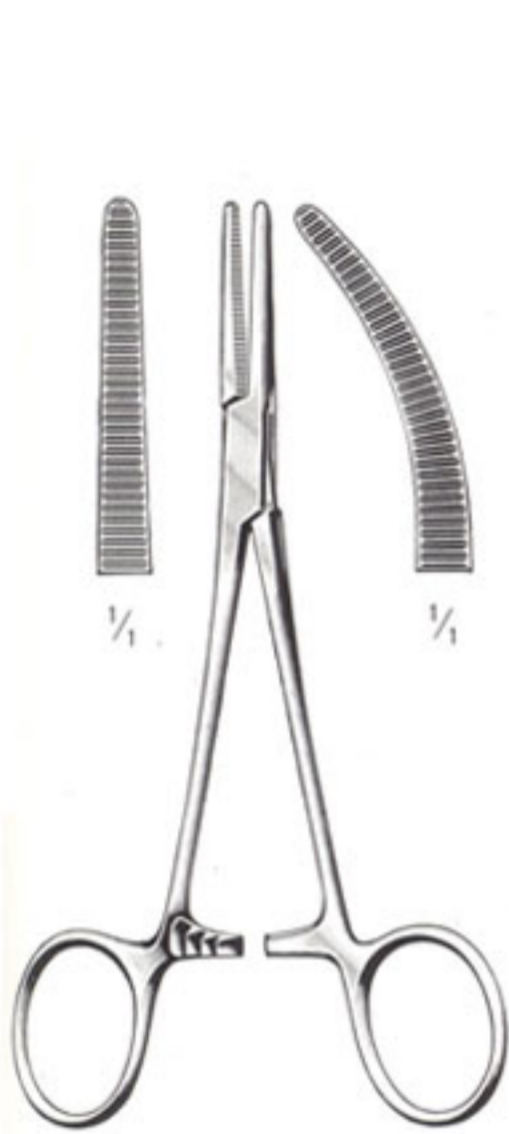

**Spencer-Wells/Jones**

	gerade straight rectas		gebogen curved curvas	
	cm	in.	cm	in.
1-248-13	13,0	5	1-249-13	
1-248-14	14,0	5½	1-249-14	
1-248-15	15,5	6	1-249-15	



**Spencer-Wells**

	gerade straight rectas		gebogen curved curvas	
	cm	in.	cm	in.
1-248-18	18,0	7	1-249-18	
1-248-20	20,0	8	1-249-20	

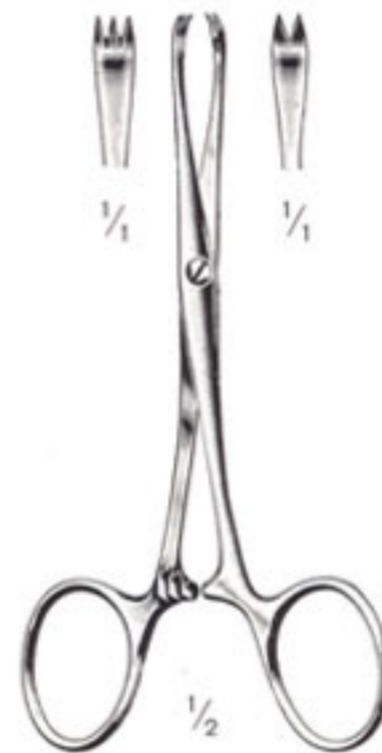

**Chaput**  
1-256-13  
13 cm / 5"

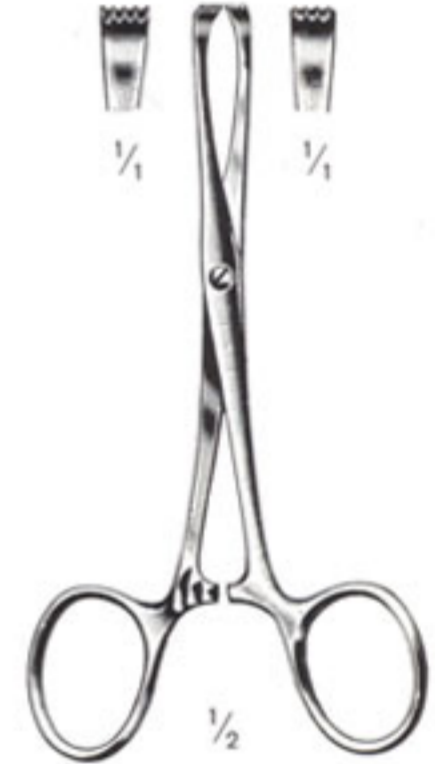

**Tuffier**  
1-258-13  
13 cm / 5"

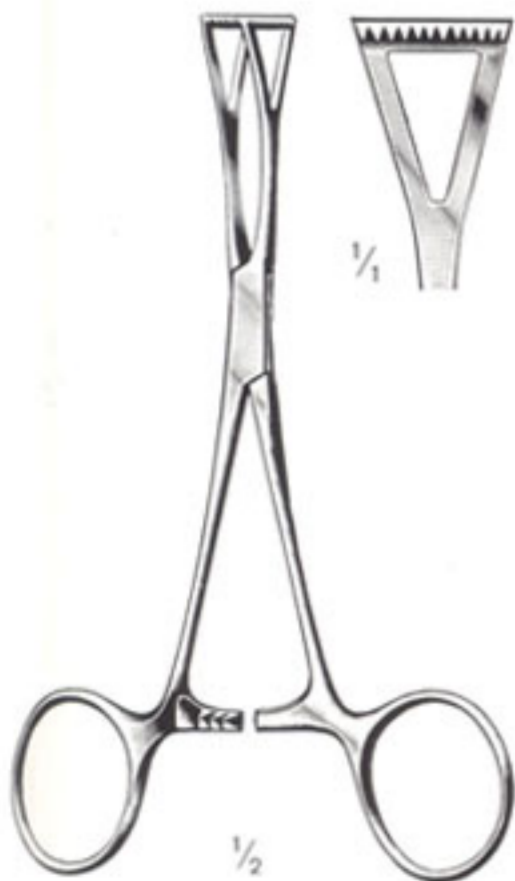

**Collin**  
1-268-14  
14 cm / 5½"



**Collin**  
1-270-16  
16 cm / 6¼"



**Collin**  
1-278-17  
16,5 cm / 6½"



# Arterienklemmen

## Artery Forceps

### Pinzas hemostaticas



**Pennington**  
15,5 cm/6" = 1-280-15  
20 cm/8" = 1-280-20

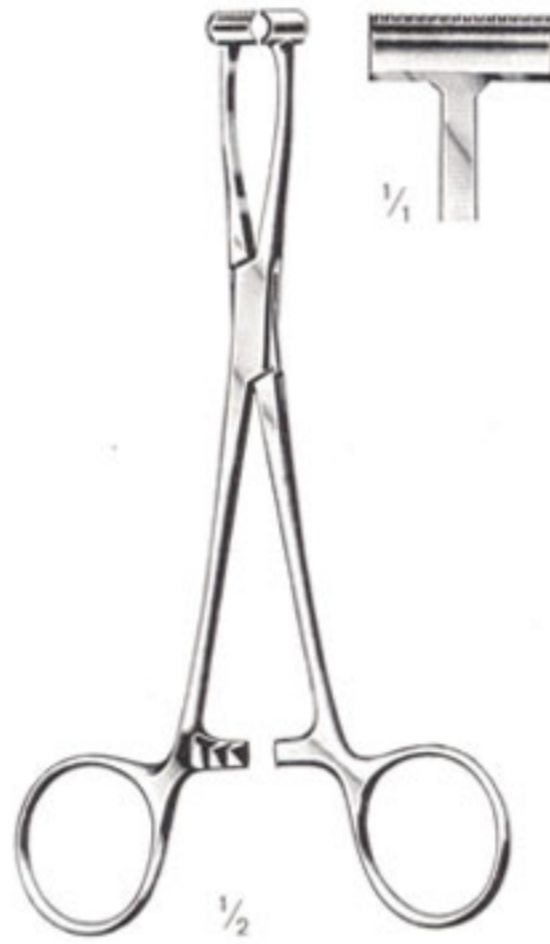

**Pratt**  
1-282-15  
15 cm/6"

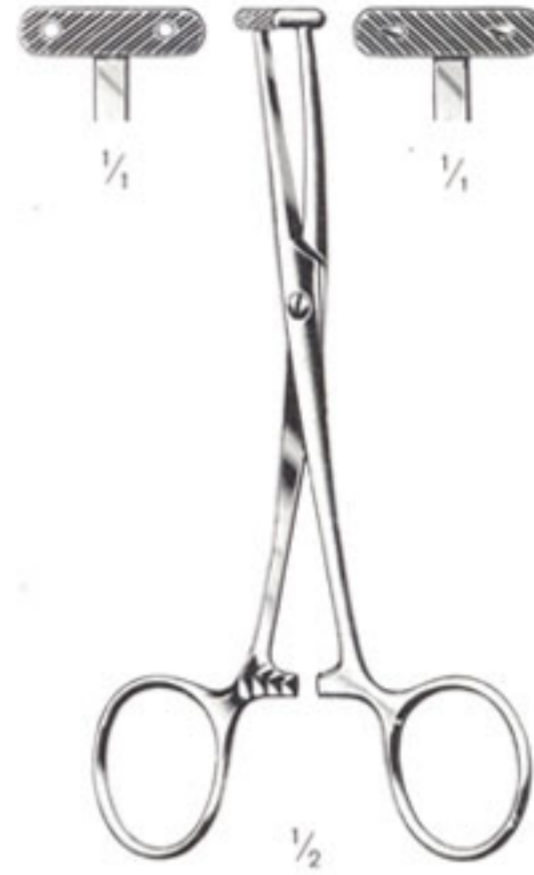

**Martel**  
1-290-14  
14 cm/5½"



**Willet-Martel**  
1-292-19  
19 cm/7½"

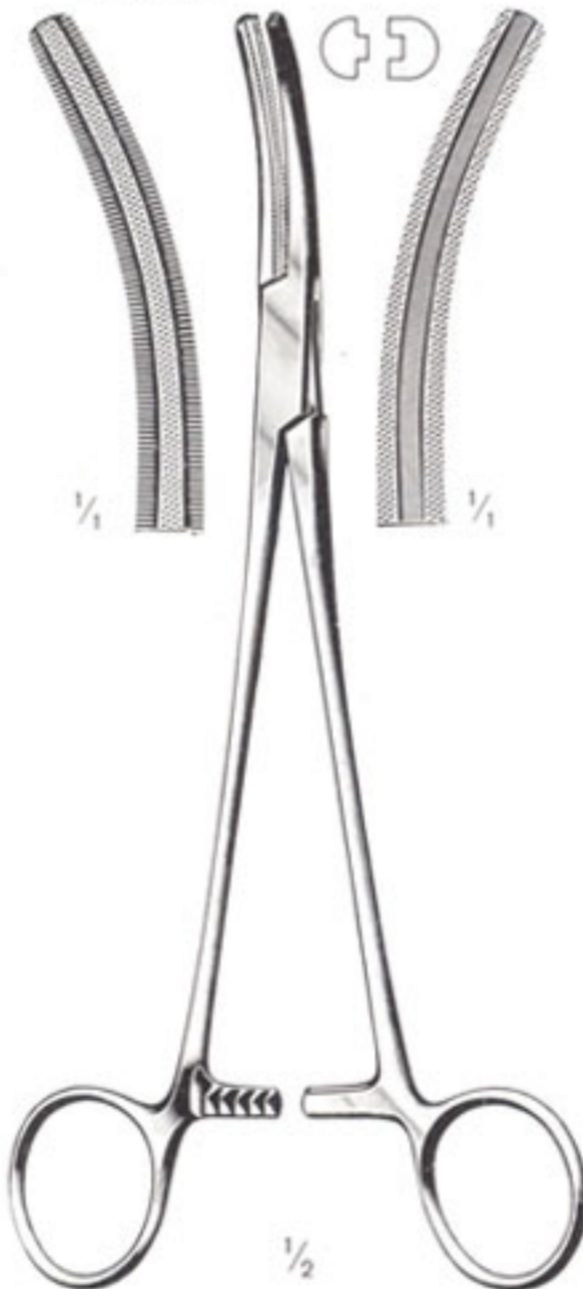

**Buie**  
1-297-21  
21 cm/8¼"

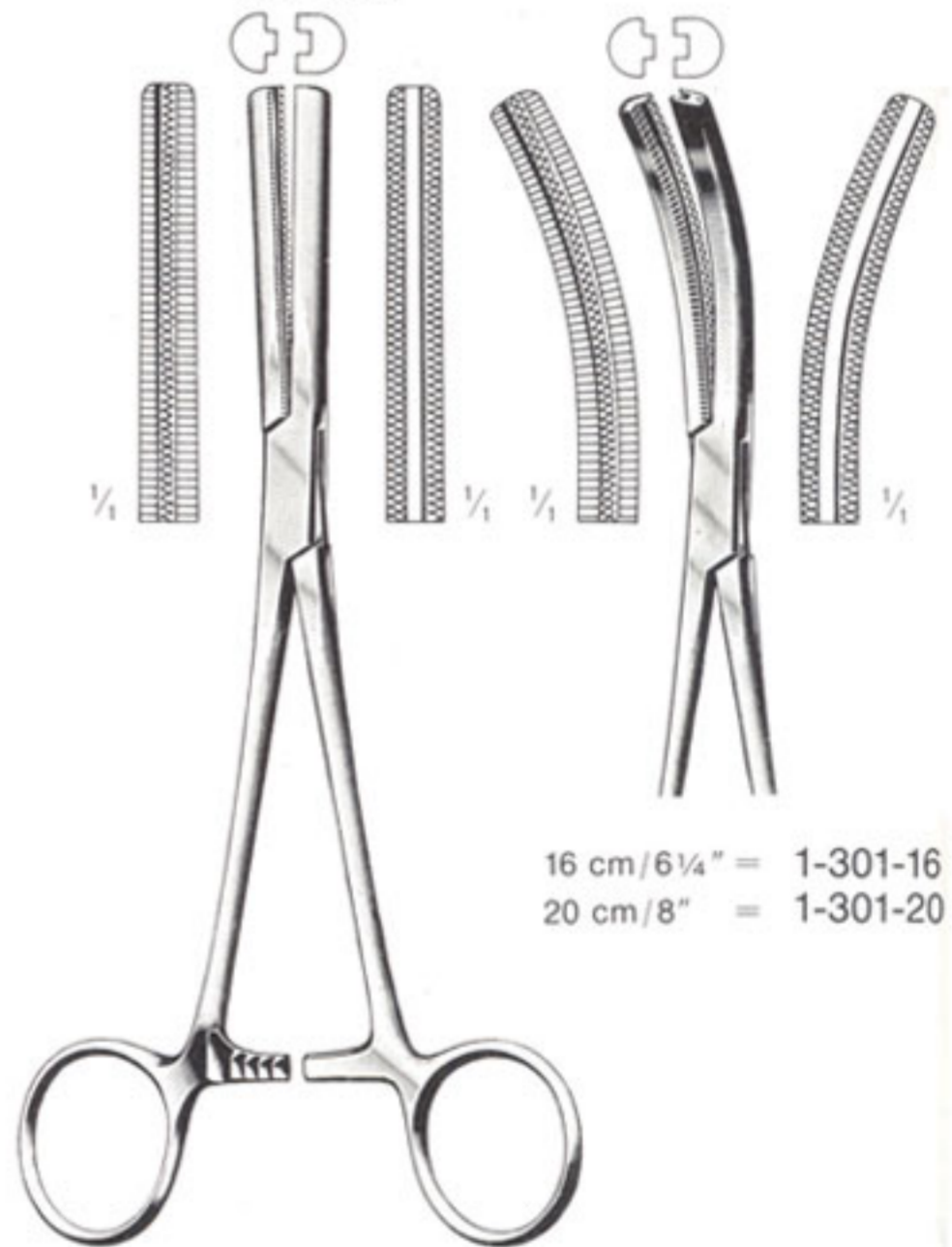

**Fergusson**  
16 cm/6¼" = 1-300-16  
20 cm/8" = 1-300-20

16 cm/6¼" = 1-301-16  
20 cm/8" = 1-301-20

1-282-15

1-290-14- 1-292-19  
1-297-21- 1-301-20

- Artery and Haemorrhoidal (Pile) Clamps
- Scalp Flap Forceps
- Angiotribes and Haemorrhoidal (Pile) Forceps

# Arterienklemmen

## Artery Forceps

### Pinzas hemostaticas

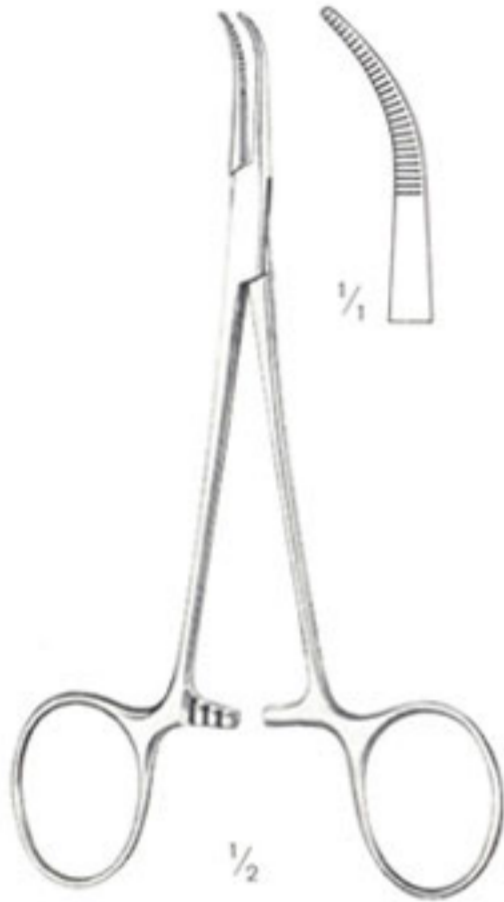

**Baby-Mixer**  
1-303-01  
14 cm / 5½"

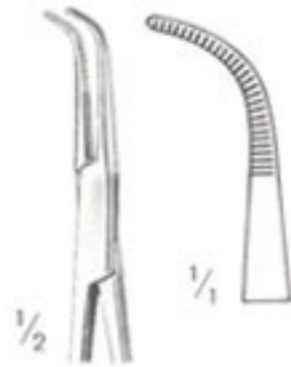

1-303-02  
14 cm / 5½"



**Barraquer**  
1-305-12  
12 cm / 4¾"



1-305-18  
18,5 cm / 7¼"



1-305-19  
19 cm / 7¼"



**Hartmann**  
1-306-10  
10 cm / 4"



**Hartmann**  
1-307-10  
10 cm / 4"

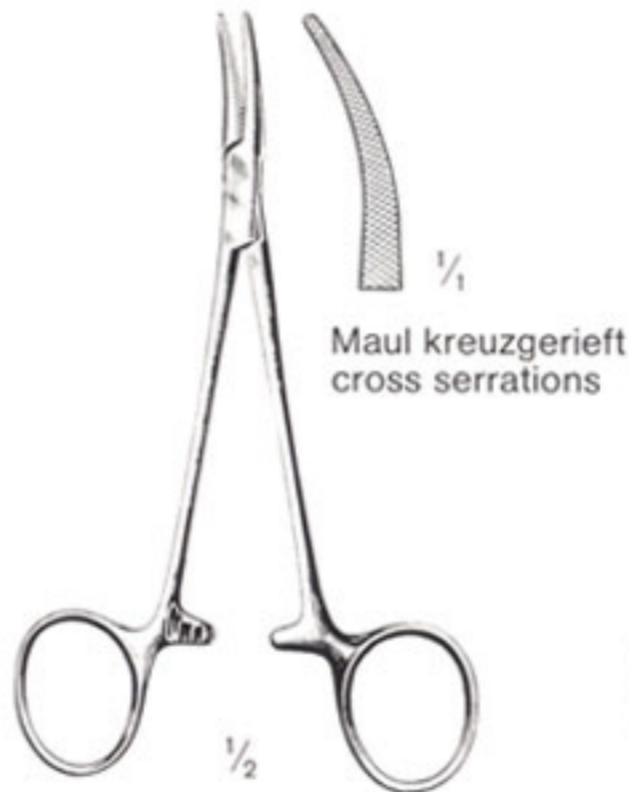

1-309-12  
12 cm / 4¾"

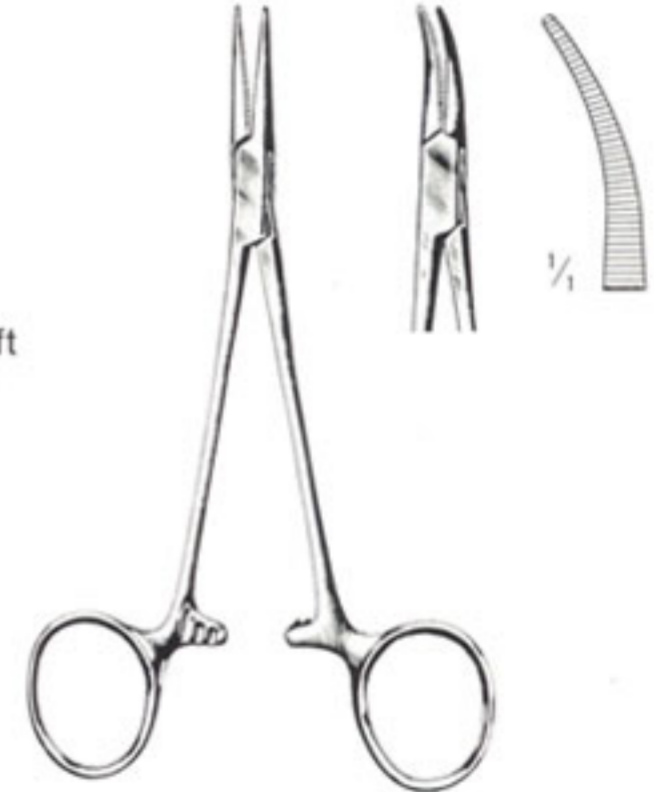

**Halsted-Mosquito**

straight	cm	in.	curved
1-310-12	12,5	5	1-311-12
1-310-14	14,0	5½	1-311-14

# Arterienklemmen

## Artery Forceps

### Pinzas hemostaticas

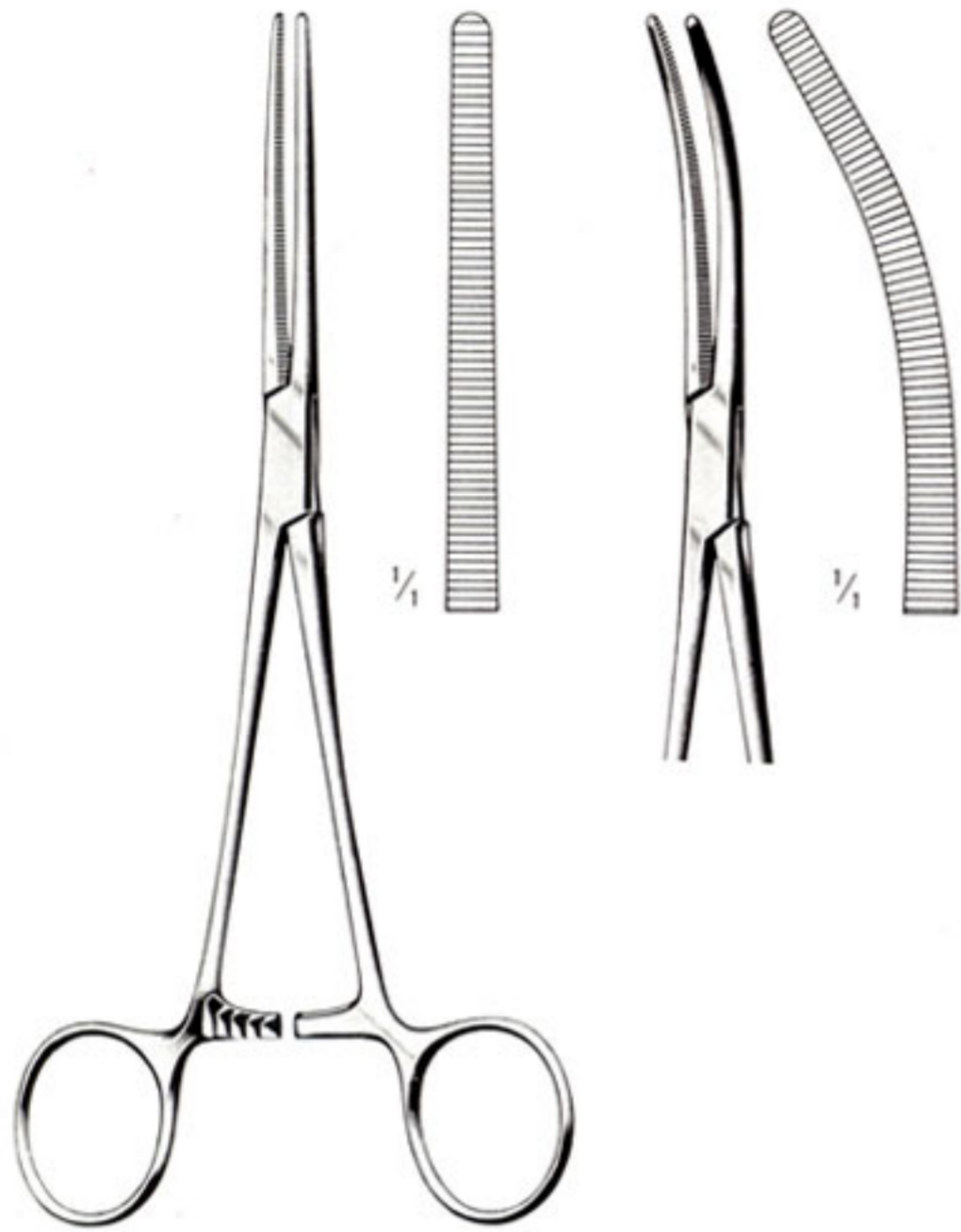

Péan (Rochester)

straight	cm	in.	curved
1-410-14	14	5½	1-411-14
1-410-16	16	6¼	1-411-16
1-410-18	18	7	1-411-18
1-410-20	20	8	1-411-20
1-410-22	22	8¾	1-411-22
1-410-24	24	9½	1-411-24
1-410-26	26	10¼	1-411-26
1-410-30	30	12	1-411-30



Kocher (Ochsner)

straight	cm	<sup>1 : 2</sup> in.	curved
1-414-14	14	5½	1-415-14
1-414-16	16	6¼	1-415-16
1-414-18	18	7	1-415-18
1-414-20	20	8	1-415-20
1-414-22	22	8¾	1-415-22
1-414-24	24	9½	1-415-24
1-414-26	26	10¼	1-415-26
1-414-30	30	12	1-415-30

# Arterienklemmen

## Artery Forceps

### Pinzas hemostaticas



Baby-Mixer  
1-419-18  
18 cm / 7"



Baby-Adson  
1-421-14  
14 cm / 5½"



Baby-Adson  
1-421-18  
18 cm / 7"

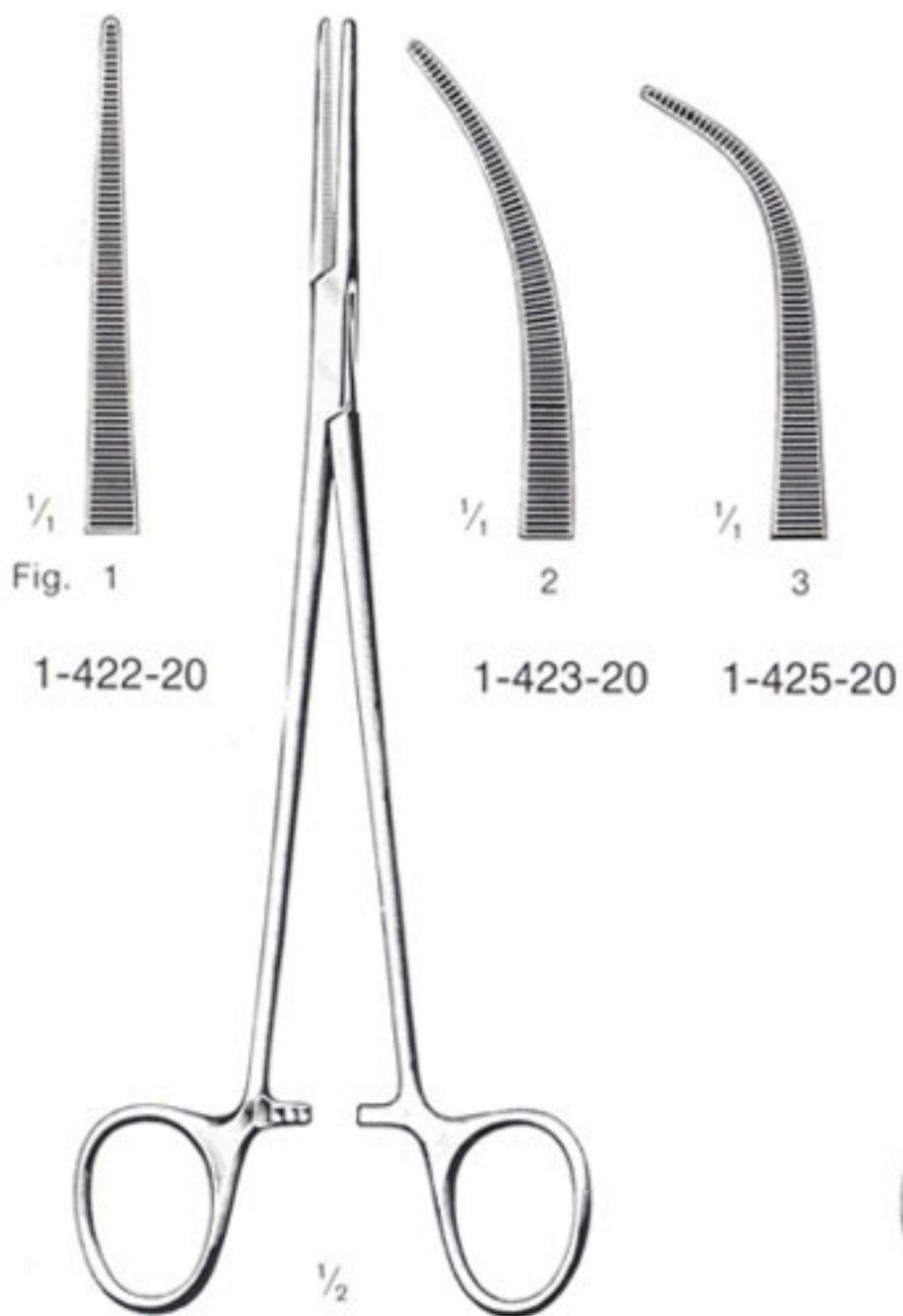

Heiss  
20 cm / 8"

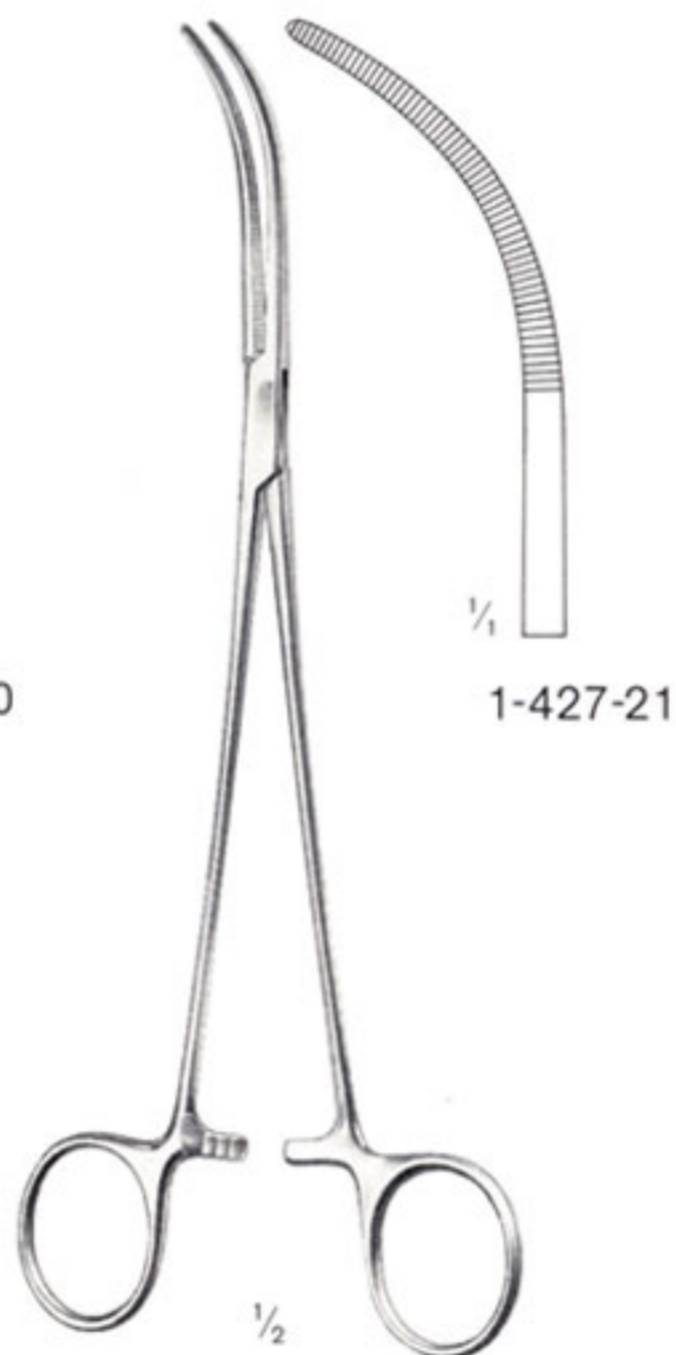

Overholt-Mixer  
21 cm / 8¼"

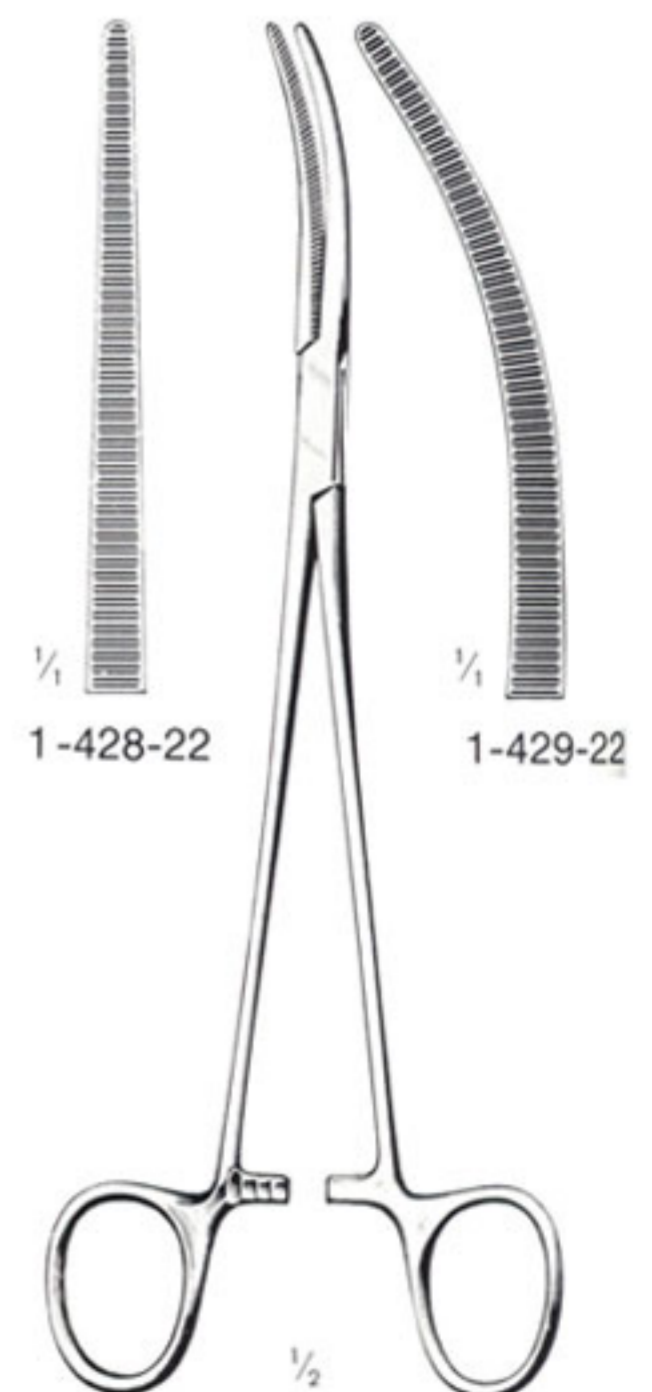

Roberts  
22 cm / 8¾"

# Arterienklemmen

## Artery Forceps

### Pinzas hemostaticas



Mixer  
15,5 cm / 6" = 1-473-15  
19 cm / 7 1/2" = 1-473-19



Mixer-O'Shaugnessy  
15,5 cm / 6" = 1-479-15  
19 cm / 7 1/2" = 1-479-19



Mixer  
1-483-22  
22 cm / 8 3/4"



Mixer  
1-485-23  
23 cm / 9"



Mixer

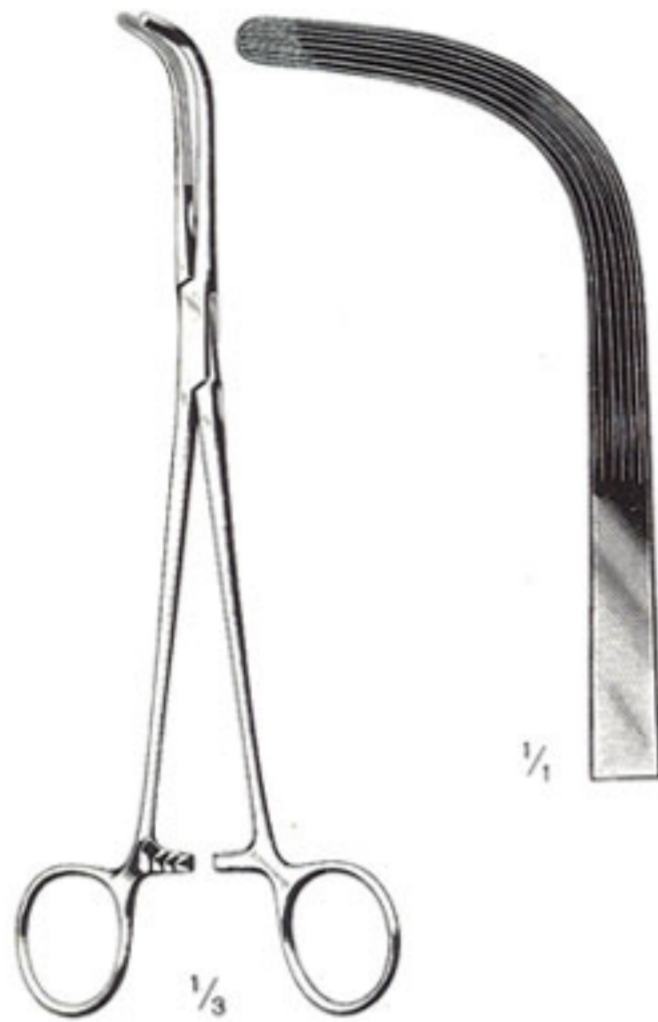

Fig. 1 2 3  
1-491-22 1-493-25 1-495-28  
22 cm / 8 3/4" 25 cm / 10" 28 cm / 11"

# Arterienklemmen

## Artery Forceps

### Pinzas hemostaticas



McQuigg-Mixer  
1-497-22  
22 cm / 8 3/4"



Lower  
1-501-18  
18 cm / 7"

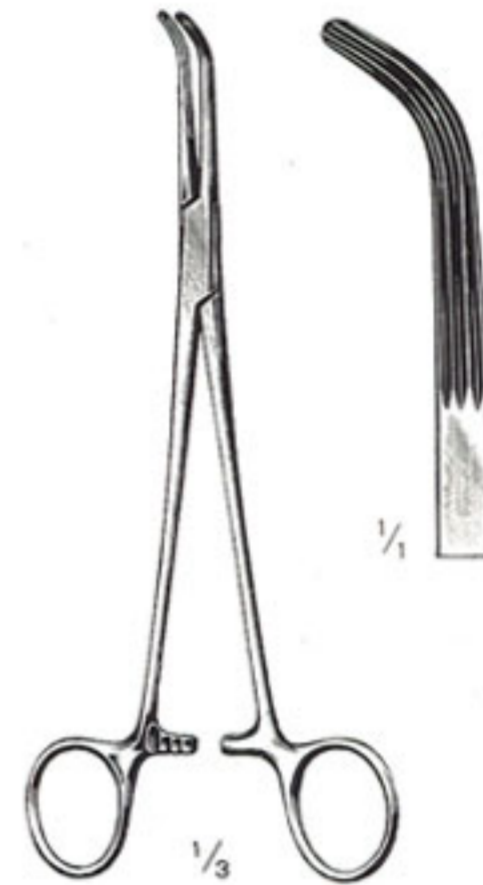

Lahey  
1-511-19  
19 cm / 7 1/2"

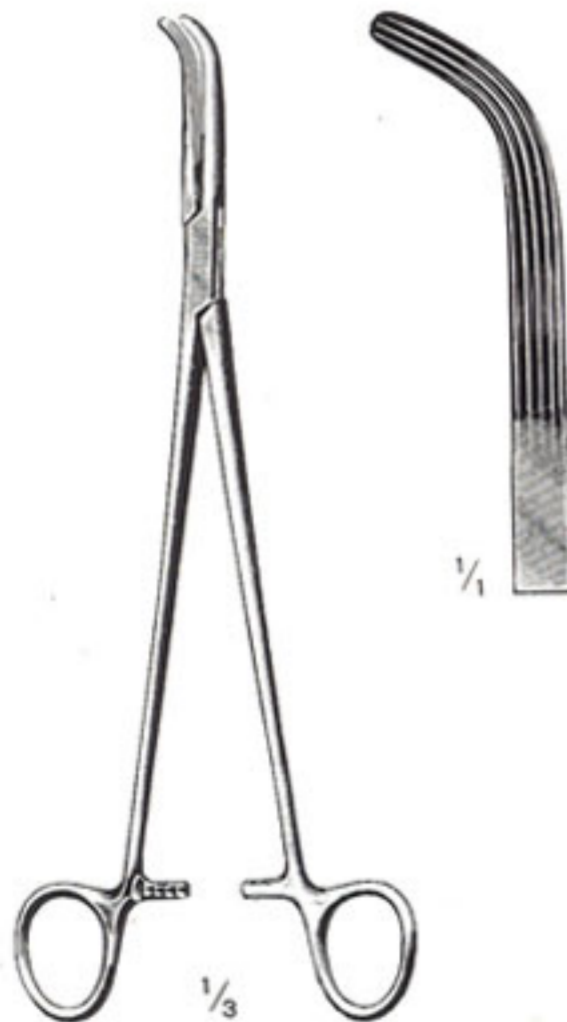

Lahey  
1-513-23  
23 cm / 9"

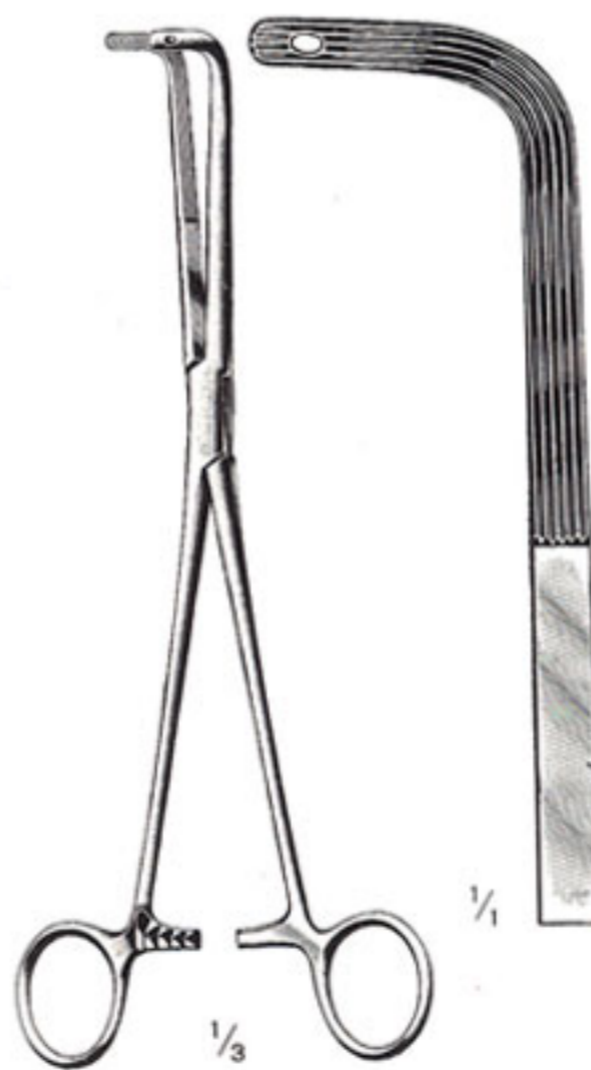

Finocchietto  
1-521-24  
24 cm / 9 1/2"