



Precision Instruments Corp

HOLLOWARE INSTRUMENTS

# Precision Instruments Corp

## Stainless Steel Instrument Trays Made of 18/8 Stainless Steel

Complete instrument tray with  
perforated base,  
lid & insert frame for 16 instrument

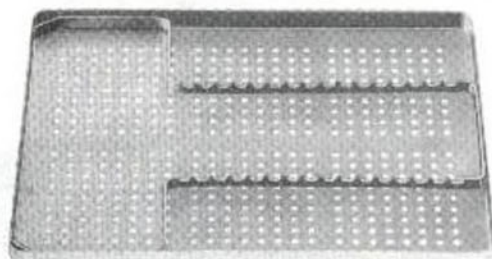

**45-ST-026**  
**288x187x40mm**

Complete instrument tray with  
perforated base,  
lid & insert frame for 23 instrument

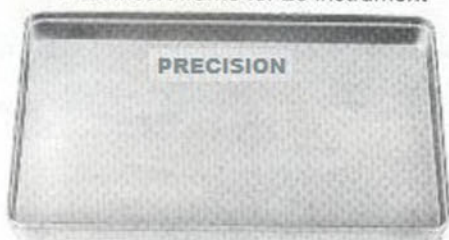

**45-ST-027**  
**288x187x40mm**

Complete instrument tray with solid base,  
lid & insert frame for 16 instrument

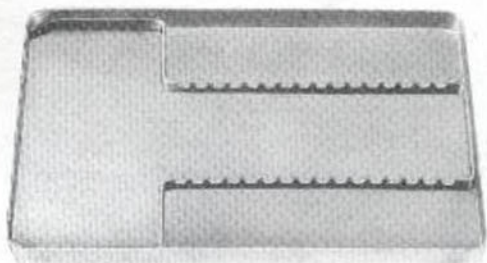
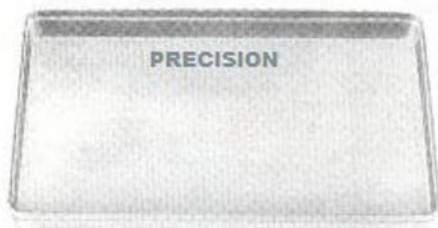

**45-ST-028**  
**284x183x40mm**

Complete instrument tray with solid base,  
lid & insert frame for 23 instrument

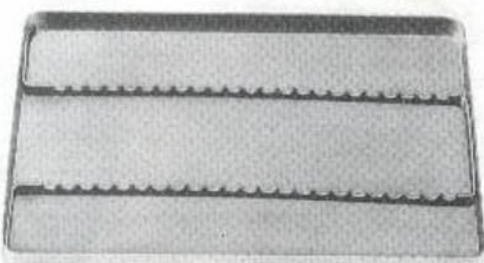
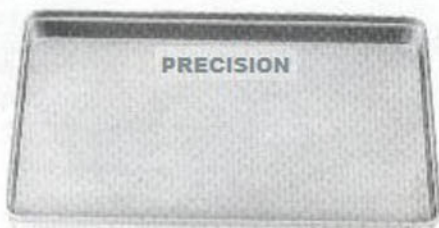

**45-ST-029**  
**284x183x40mm**

TOP QUALITY HOLLOW WARE PRODUCTS.

# Precision Instruments Corp

## Stainless Steel Instrument Trays & Boxes Made of 18/8 Stainless Steel

Scalers Tray

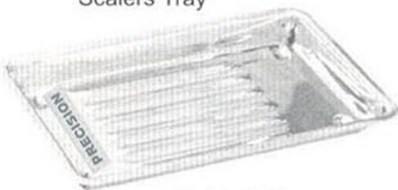

**45-ST-030**  
**5" x 4" x 3/4"**



**45-ST-031**  
**4" x 6" x 1"**  
**4" x 8" x 1 1/2"**  
**6" x 10" x 2"**  
**6" x 12" x 2"**



**45-ST-032**  
**4" x 6" x 1"**  
**4" x 8" x 1 1/2"**  
**6" x 8" x 2"**  
**8" x 10" x 2"**



**45-ST-033**  
**8 1/2" x 3" x 1 1/4"**  
**10" x 4" x 1 1/2"**



**45-ST-034**



**45-ST-035**  
**Endodontic box**

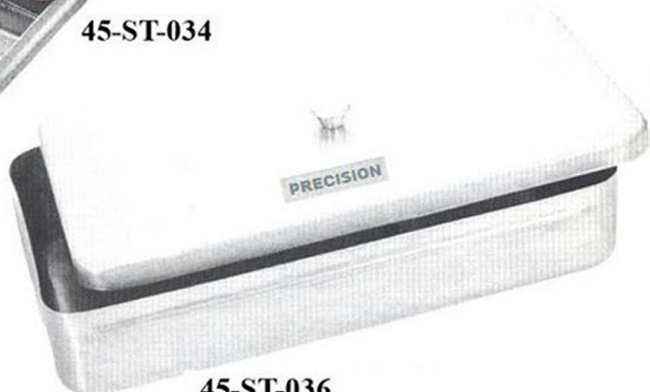
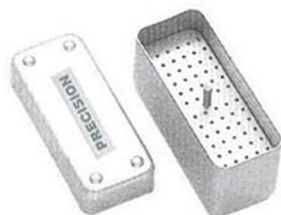

**45-ST-036**  
**4" x 6" x 1"**    **4" x 8" x 1 1/2"**  
**6" x 10" x 2"**    **6" x 12" x 2"**

TOP QUALITY HOLLOW WARE PRODUCTS

**15-ST-037**  
**Round Bowls**

**Stainless Steel Instrument Trays**  
**Made of 18/8 Stainless Steel**

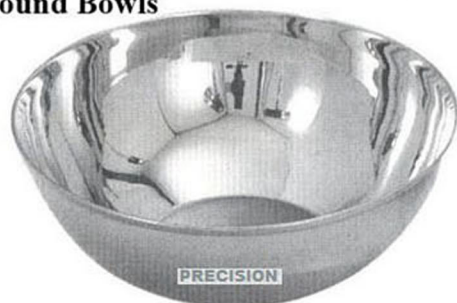

116 x 50 mm  
128 x 55 mm  
147 x 65 mm  
167 x 75 mm  
187 x 85 mm

Kidney trays with & without Lid

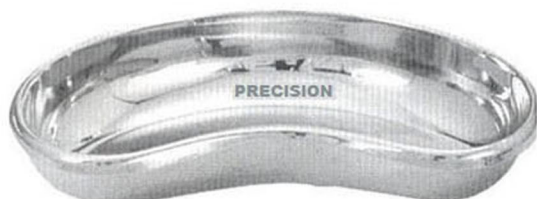

**45-ST-038**  
300mm - 250mm - 200mm  
175mm - 150mm



**45-ST-040**  
**Sterilizing Drums**  
Available in a lot of  
different sizes according  
to your requirements



**45-ST-042**  
**Spirit Lamp**

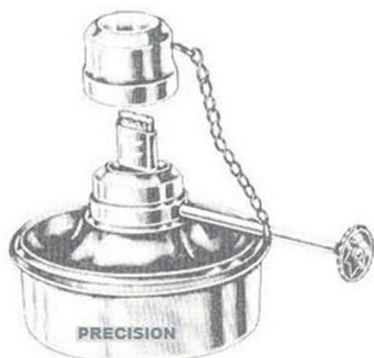

**45-ST-041**  
**Spirit Lamp**



**45-ST-043**  
**Spirit Lamp**



**45-ST-044**  
**Forceps Jar**



## Stainless Steel Urinal Instruments Made of 18/8 Stainless Steel



**45-ST-051**  
**Urinal Jun**



**45-ST-052**  
**Urinal Female**



**45-ST-053**  
**Fetal Scope**

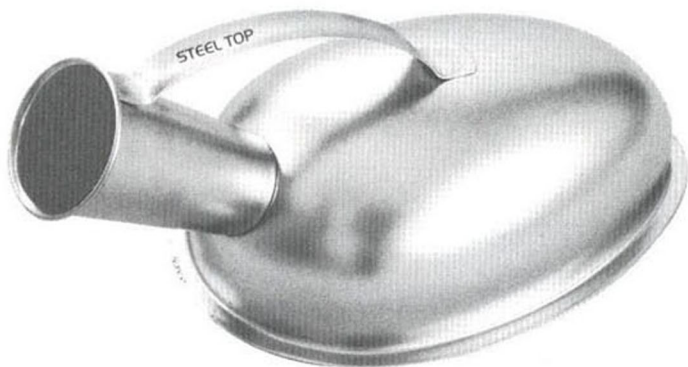

**45-ST-054**  
**Urinal Male**

# Precision Instruments Corp

## Dressing Sterilizing Drums

Cajas (Tambores) para esterilizacion

Verbandstofftrommeln

mm

mm

80 80 100-200-08

120 120 100-200-12

140 140 100-200-14

160 120 100-200-16

160 150 100-200-17

190 150 100-200-19

190 190 100-200-20

240 160 100-200-23

240 240 100-200-24

290 160 100-200-28

290 240 100-200-29

340 160 100-200-33

340 240 100-200-34

39 190 100-200-38

390 290 100-200-39



Schimmelbusch

# Precision Instruments Corp

Sterilizing Trays (Wire mesh), Bandejas de esterilizacion de Alambre para, Sterilisierröhrschale aus Drahtgeflecht



110-808-24

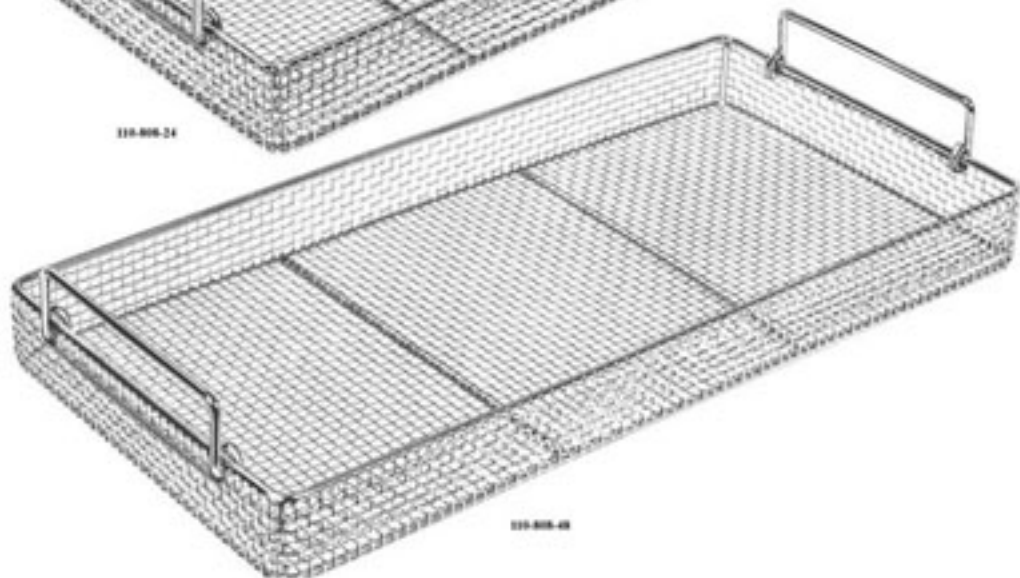

110-808-48

# Precision Instruments Corp

Sterilizing tray of perforated steel sheet, Bandeja de esterilizacion de chapa de acero, Sterilisiersiebschale aus perforiertem Blech



110-809-24

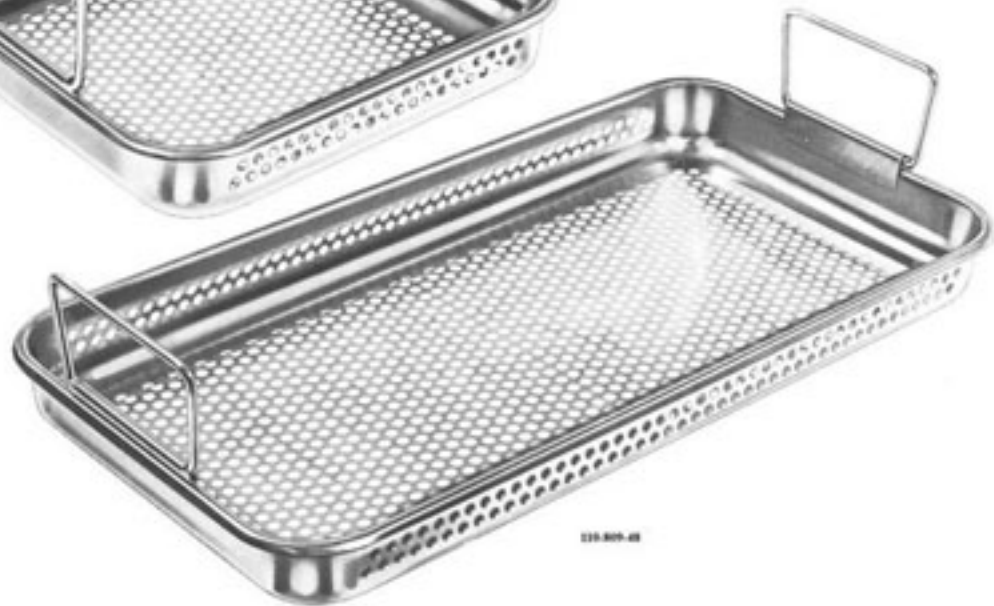

110-809-48



Precision Instruments Corp

Container, Contenedores, Container



# Precision Instruments Corp

## Container, Contenedores, Container

115-813-07



Container 275 x 275 x 70 mm

115-813-15



Container 275 x 275 x 130 mm

115-813-30



Container 275 x 275 x 260 mm

115-816-07



Container 575 x 275 x 70 mm

115-816-15



Container 575 x 275 x 130 mm

115-816-30



Container 575 x 275 x 260 mm

# Precision Instruments Corp

## Container, Contenedores, Container

115-823-07



Container 275 x 275 x 70 mm

115-823-15



Container 275 x 275 x 130 mm

115-823-30



Container 275 x 275 x 260 mm

115-826-07



Container 575 x 275 x 70 mm

115-826-15



Container 575 x 275 x 130 mm

115-826-30

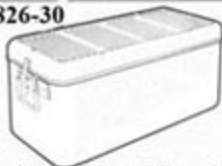

Container 575 x 275 x 260 mm

# Precision Instruments Corp

## Container, Contenedores, Container

115-853-07



Container 275 x 275 x 70 mm

115-853-15



Container 275 x 275 x 130 mm

115-863-30



Container 275 x 275 x 260 mm

115-856-07



Container 575 x 275 x 70 mm

115-856-15



Container 575 x 275 x 130 mm

115-856-30

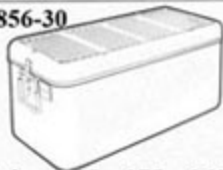

Container 575 x 275 x 260 mm



# Precision Instruments Corp

## Container, Contenedores, Container

115-863-07



Container 275 x 275 x 70 mm

115-863-15



Container 275 x 275 x 130 mm

115-863-30



Container 275 x 275 x 260 mm

115-866-07



Container 575 x 275 x 70 mm

115-866-15



Container 575 x 275 x 130 mm

115-866-30



Container 575 x 275 x 260 mm

Disposal Containers, Contenedores de evacuacion, Entsorgungs-Container



120-873-15 - 120-876-30

120-873-15



Container 275 x 275 x 130 mm

120-873-30



Container 275 x 275 x 260 mm

120-876-15



Container 575 x 275 x 130 mm

120-876-30



Container 575 x 275 x 260 mm

## Sterilizing Boxes, Recipientes de esterilizacion, Sterilisierbehälter



130-883-07



275 x 275 x 70 mm

130-883-15



275 x 275 x 130 mm

130-883-20



275 x 275 x 200 mm

130-883-30



275 x 275 x 260 mm

130-886-07



575 x 275 x 70 mm

130-886-15



575 x 275 x 130 mm

130-886-20



575 x 275 x 200 mm

130-886-30



575 x 275 x 260 mm

## Sterilizing Baskets, Cestas de esterilizacion, Sterilisier-Korbe

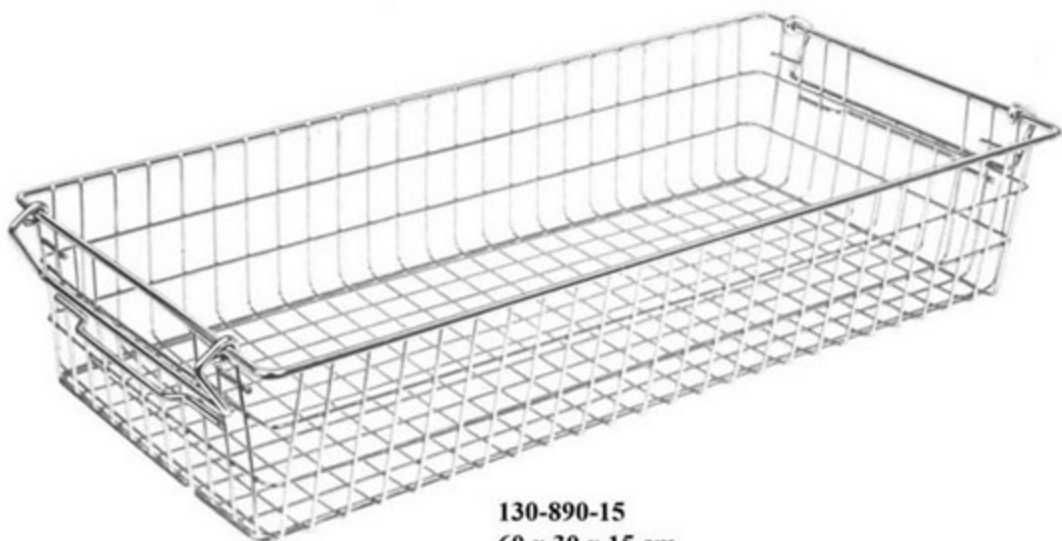

**130-890-15**  
**60 x 30 x 15 cm**

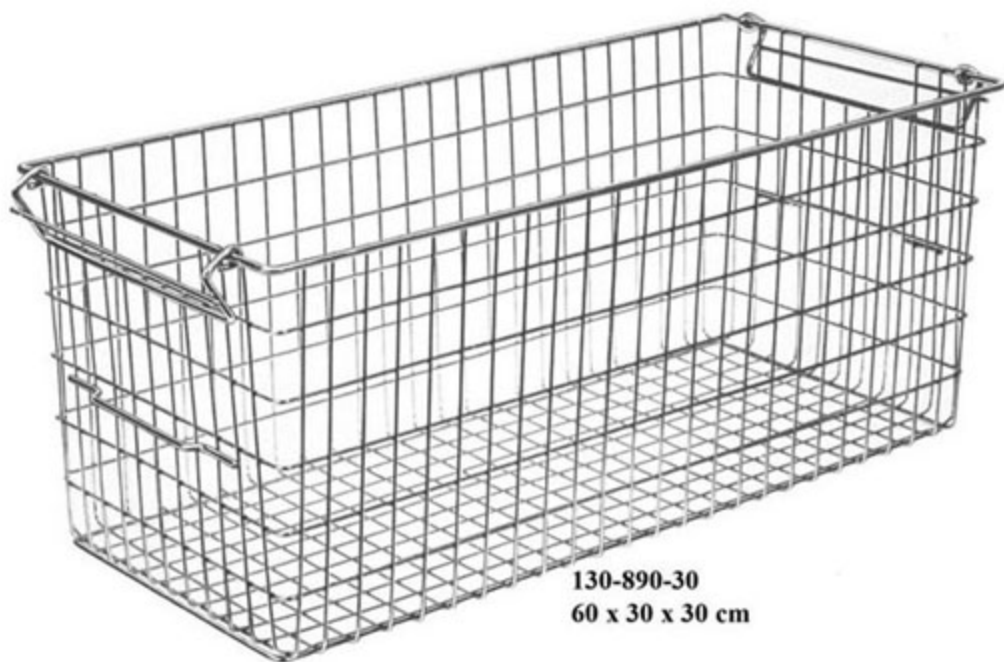

**130-890-30**  
**60 x 30 x 30 cm**



# Precision Instruments Corp

## Irrigators – Irrigadores – Irrigatoren



- |     |            |
|-----|------------|
| 1.0 | 145-110-10 |
| 1.5 | 145-110-15 |
| 2.0 | 145-110-20 |

Jugs for Aqua dest. – Jarras para aqua dest. – Kannen für Aqua destillata



100 x 165	1.0	145-140-10
130 x 200	2.0	145-140-20
155 x 220	3.0	145-140-30
175 x 265	5.0	145-140-50

## Universal Pitchers – Jarras Universales – Mehrzweckkannen



0.5	145-150-05
1.0	145-150-10
2.0	145-150-20
3.0	145-150-30

# Precision Instruments Corp

## Solution Bowls – Cubetas para soluciones – Spulschalen (Kummen)

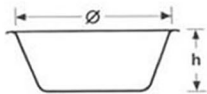

165 x 60	160-170-16
175 x 70	160-170-17
220 x 80	160-170-22
225 x 90	160-170-23
240 x 110	160-170-24
255 x 115	160-170-25
275 x 115	160-170-27
290 x 125	160-170-29
310 x 120	160-170-31
345 x 125	160-170-34
380 x 130	160-170-38
415 x 140	160-170-41



# Precision Instruments Corp

## Wash Bowl – Palangana – Waschschüssel



330 x 90

160-176-33

330 x 115

160-178-33

# Precision Instruments Corp

## Round Dish – Cubeta redonda – Runde Schale



160-225-11



110 x 27

160-224-11

110 x 40

160-226-11

## Round Bowls , Funnels, Graduated Measures, Petri Dishes Cubetas redondas, Embudos, Copas graduadas, Cubetas de Petri Rund Schalen, Trichter, Meßbecher, Mehrzweckschale Petri

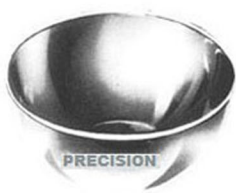

40 x 90	170-231-04
61 x 30	170-231-06
116 x 50	170-231-11
128 x 55	170-231-12
147 x 65	170-231-14
167 x 75	170-231-16
187 x 85	170-231-18

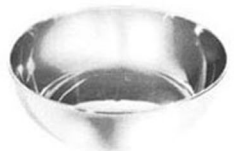

116 x 35	170-235-11
128 x 38	170-235-12
147 x 40	170-235-14
157 x 45	170-235-16
187 x 45	170-235-18



110 x 28 170-240-11



100	170-265-10
120	170-265-12
150	170-265-15



170-254-01  
100 cc = 0.1L



170-256-02 = 0.25L  
170-256-05 = 0.5L  
170-256-10 = 1.0L  
170-256-20 = 2.0L



170-280-10  
100 x 20 mm



170-284-09 = 96 x 20 mm  
170-290-10 = 100 x 20 mm  
170-295-10 = 100 x 16 mm

# Precision Instruments Corp

**Universal Trays, Instrument Storing Trays**

**Bandejas para instrumentos etc.**

**Eckige Mehrzweckschalen, instrumentenablageplatten**



230 x 155 x 30	175-321-23
300 x 175 x 30	175-321-30
300 x 175 x 40	175-321-31
350 x 240 x 36	175-321-35
400 x 300 x 50	175-321-40

210 x 160 x 10	175-324-21
240 x 180 x 10	175-324-24
310 x 150 x 10	175-324-30
310 x 210 x 10	175-324-31
350 x 240 x 10	175-324-35
400 x 270 x 20	175-324-40
420 x 280 x 10	175-324-42

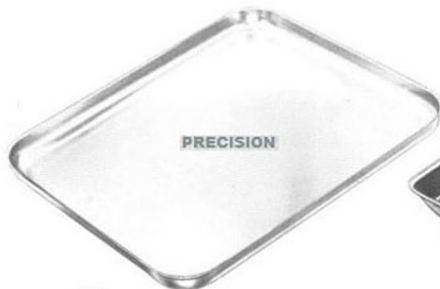

**Krenn**  
175-328-21  
193 x 163 x 13 mm



175-332-12  
125 x 80 x 12 mm



## Trays and Jars Bandejas rectangular y redonda, Tarros Schwensschalen, standgefäße



180-340-23  
235 x 190 x 40 mm



180-348-22  
220 x 70 mm

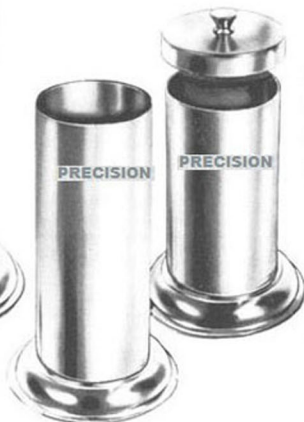
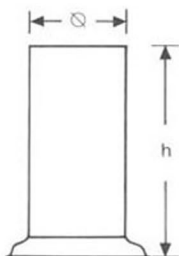
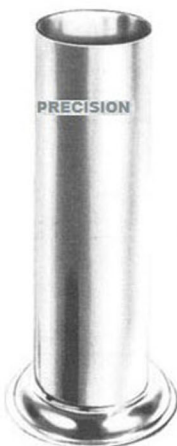

30 x 90	180-360-30
50 x 100	180-360-30
50 x 130	180-360-30
50 x 175	180-360-30
75 x 100	180-360-30
75 x 130	180-360-30
75 x 175	180-360-30
100 x 175	180-360-30
100 x 200	180-360-30

## Instrument and Syringe Boxes Cajas par instrumentos y jeringas Instrumenten-und injektionsspritzenkasten



165 x 85 x 35	185-411-16
200 x 100 x 35	185-411-20
200 x 100 x 50	185-411-21
230 x 130 x 50	185-411-23
260 x 150 x 50	185-411-26
270 x 235 x 50	185-411-27
300 x 200 x 50	185-411-30
325 x 275 x 30	185-411-32
325 x 275 x 50	185-411-33
420 x 80 x 40	185-411-42
420 x 175 x 50	185-411-43



185-419-20  
205 x 105 x 40 mm

# Precision Instruments Corp

Containers for cotton wool, pellets, Medicine Cups and Spoons, Trays for Tablets etc.  
 Recipientes para algodón, tapones, vasos y cucharas graduados, Bandejas para tabletas etc.  
 Dosen für watte, tampons, Medizinbecher,- löffel , Tabletten – und Kleinschalen

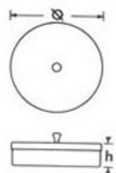

75 x 60	190-430-06
75 x 75	190-430-07
100 x 60	190-430-06
100 x 100	190-430-10
125 x 80	190-430-08

125 x 125	190-430-12
135 x 20	190-430-02
135 x 35	190-430-03
135 x 50	190-430-05
150 x 100	190-430-10

150 x 150	190-430-15
200 x 100	190-430-10
200 x 150	190-430-15
200 x 200	190-430-20
240 x 160	190-430-16

240 x 230	190-430-23
290 x 160	190-430-16
290 x 240	190-430-24



190-602-25  
25 cc



190-604-50  
50 cc



190-610-20  
20 cc



190-620-75  
75 x 12 mm

## Sputum Cups, Kindney Bowls (Emesis Basins) Escupideras, Rinoneras, Cunas (Silletas) Sputumbecher, Nierenschalen



200-662-75  
75 x 80 mm



200-664-75  
75 x 80 mm



200-666-75  
75 x 80 mm



200-669-75  
73 x 75 mm

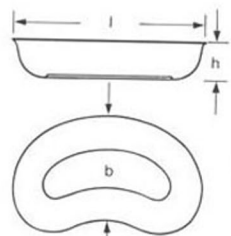

170 x 100 x 35  
250 x 140 x 40  
275 x 150 x 45



200-673-17  
200-673-25  
200-673-27

**Triangular Basin, Placenta Pan, Placenta Plate**  
**Cubeta triangular para urologia, Cubetas para placenta**  
**Dreieckschale, Placentabecken, - teller**



210-740-30



210-741-30



210-750-36



210-752-36



210-754-34  
340 mm