

The logo for Precision Instruments Corp features the company name in a white, sans-serif font. The text is split across two overlapping horizontal bars: an orange bar on the left and a black bar on the right. The background of the entire page is white, with a large, vibrant blue circular shape on the left side that partially overlaps the orange bar.

Precision Instruments Corp

Surgical Instruments

INDEX

Sec1:A- GENERAL INSTRUMENTS - ALLGEMEINES INSTRUMENTARIUM - INSTRUMENTOS GENERAL

1. Arterienklemmen
Artery Forceps 5 to 17 pages
Pinzas hemostaticas
2. Nierenstielklemmen
Kidney Pedical Clamp Forceps 18 to 19 pages
Pinzas-clamps para pedunculos renales
3. Gallenkanalkemmen
Gall Duct Clamps 20 to 21 pages
Pinzas para conducto biliar
4. Tuchklemmen
Towel Forceps 22 to 23 pages
Pinzas para compresas, Pinzas de campo
5. Korn-(Polypen-)Zangen, Tuferzangen
Polypus and Dressing Forceps, Cotton Swab 24 to 26 pages
forceps
Pinzas para polipos y vendajes, Pinzas para tapones

Sec1:B- GENERAL INSTRUMENTS - ALLGEMEINES INSTRUMENTARIUM - INSTRUMENTOS GENERAL

1. Anatomische Pinzetten
Dressing Forceps 27 to 29 pages
Pinzas de diseccion
2. Chirurgische Pinzetten
Tissue Forceps 30 to 32 pages
Pinzas de diseccion con dientes
3. Splitterzangen
Splinter Forceps 33 to 34 pages
Pinzas para espinas

INDEX

Sec1:C- GENERAL INSTRUMENTS- ALLGEMEINES INSTRUMENTARIUM - INSTRUMENTOS GENERAL

1. Chirurgische Scheren
Operating Scissors 35 to 37 pages
Tijeras para cirugia
2. Gynakologische Scheren
Gynecological Scissors 38 to 39 pages
Tijeras para ginecologia
3. Praparierscheren
Dissecting Scissors 40 to 40 page
Tijeras para preparaciones
4. Thoraxscheren, Gefabscheren
Scissors, Thorax and Vascular 41 to 42 pages
Tijeras toracicas y vasculares
5. Scheren fur Neuro-und Gehirnchirurgie
Brain and Neurosurgical Scissors 43 to 43 page
Tijeras para cirugia cerebl y neurocirugia
6. Tonsillen-und Nasenscheren, Episiotomie-Scheren
Tonsil ,Nasal and Episiotomy Scissors 44 to 44 page
Tijeras nasales y para amigdalas, Tijeras para episiotomia
7. Nabelschnur-Scheren, feine chirurgische Scheren
Umbilical Scissorsand, Fine Operating Scissors 45 to 45 page
Tijeras umbilicales, Tijeras finas para cirugia
8. Feine chirurgische Scheren, Augenscheren
Fine Operating Scissors, Eye Scissors 46 to 46 page
Tijeras finas para cirugia, Tijeras oculares

INDEX

Sec1:C- GENERAL INSTRUMENTS- ALLGEMEINES INSTRUMENTARIUM - INSTRUMENTOS GENERAL

9. Micro-Scheren,Darmscheren,Nagelspaltscheren,Ligaturscheren
Micro Scissors,Enterotomy, Nail splitting and Ligature Scissors 47 to 47 page
Micro-Tijeras,Tijeras para ligaduras,para hender unas y enterotomos
10. Ligaturscheren,Fadenscheren
Ligature Scissors 48 to 48 page
Tijeras para ligaduras
11. Draht-und Blechscheren
Wire and Plate Shears 49 to 49 page
Cizallas para cortar alambre y chapas metalicas

Sec1:D- GENERAL INSTRUMENTS - ALLGEMEINES INSTRUMENTARIUM - INSTRUMENTOS GENERAL

1. Wundhaken
Retractors 50 to 59 pages
Separadores
2. Bauchdeckenhalter,Wundspreizer
Abdominal and Vaginal Retractors 60 to 64 pages
Separadores abdominales,Separadores

Arterienklemmen

Artery Forceps

Pinzas hemostaticas



Halsted-Mosquito

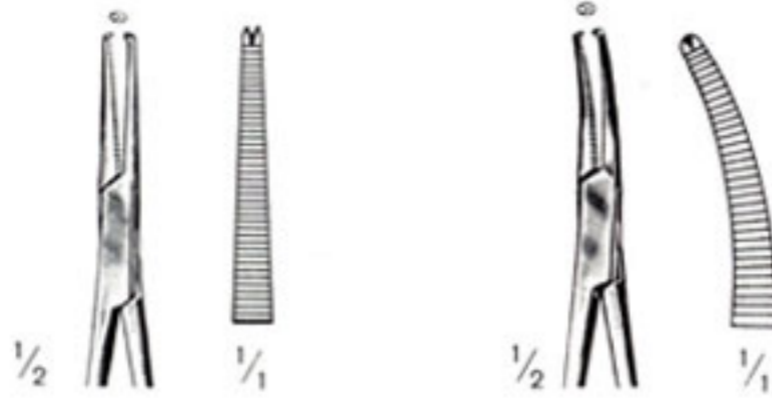

Halsted-Mosquito

gerade straight rectas	1 : 2		gebogen curved curvas
	cm	in.	
1-312-12	12,5	5	1-313-12
1-312-14	14,0	5½	1-313-14



1-314-15
15 cm / 6"

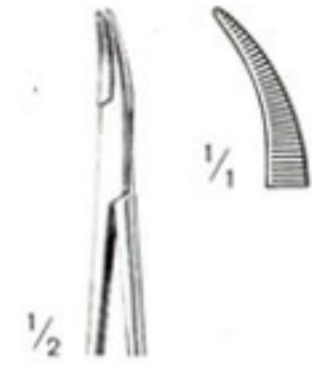

1-315-15
15 cm / 6"

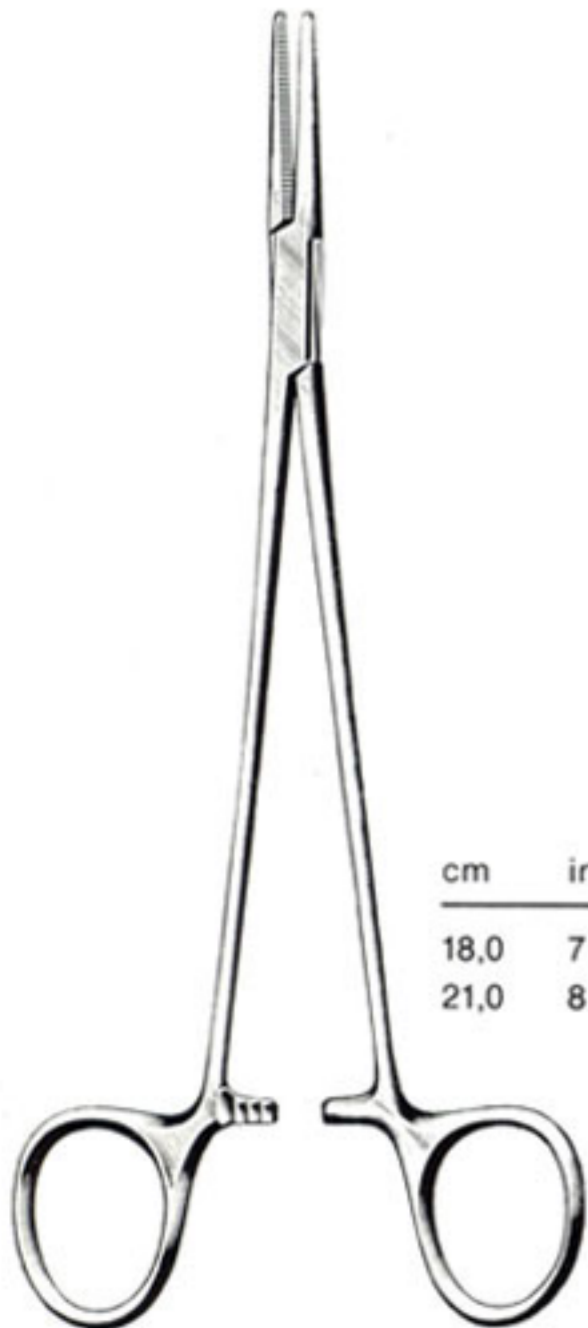

Halsted-Mosquito

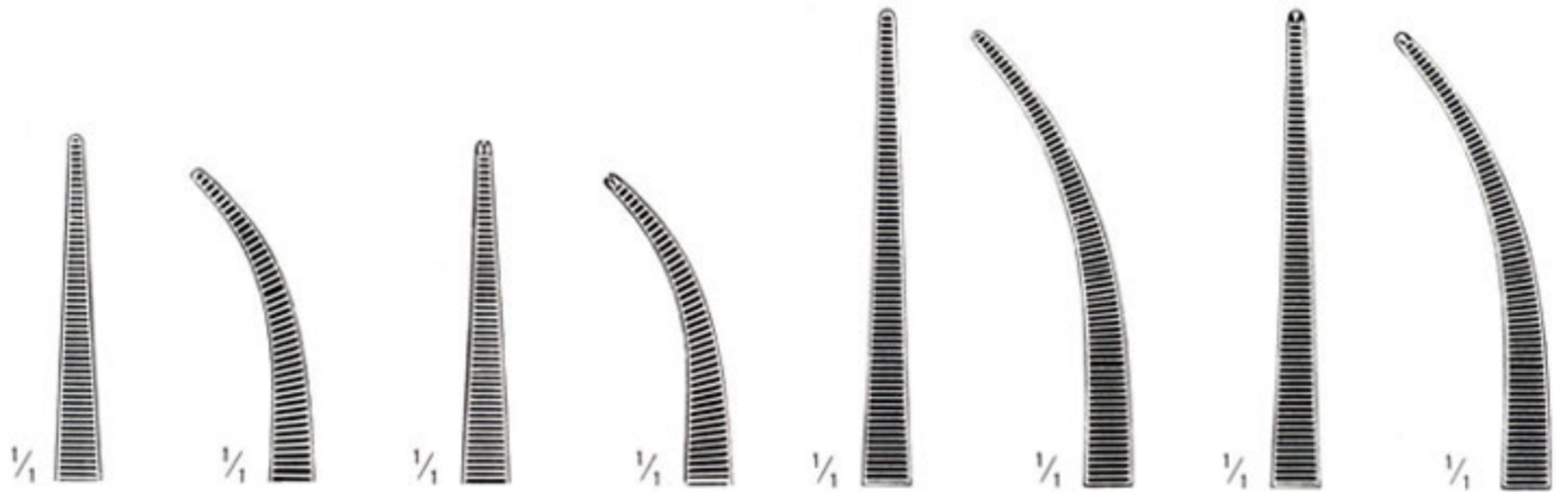

cm	in.	gerade straight rectas	gebogen curved curvas	gerade straight rectas	gebogen curved curvas	gerade straight rectas	gebogen curved curvas	gerade straight rectas	gebogen curved curvas
18,0	7	1-316-18	1-317-18	1-318-18	1-319-18	1-316-21	1-317-21	1-318-21	1-319-21
21,0	8¼								

Arterienklemmen

Artery Forceps

Pinzas hemostaticas

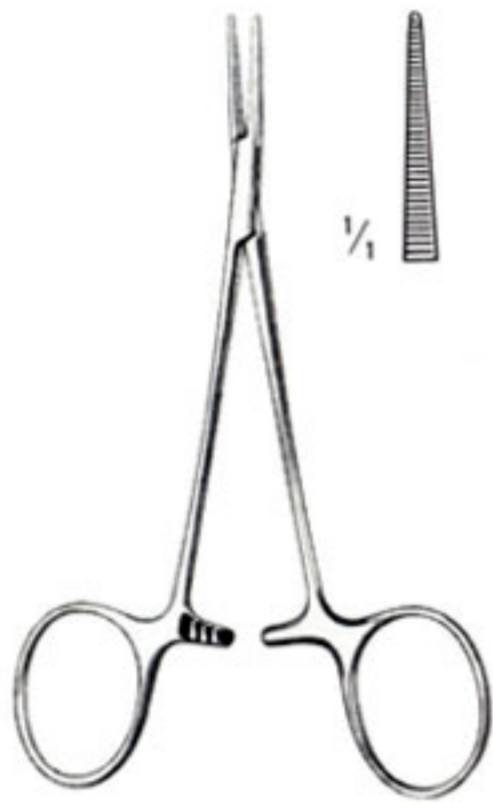

Micro-Mosquito

1-320-10 = 10 cm / 4"

1-320-12 = 12 cm / 4 3/4"

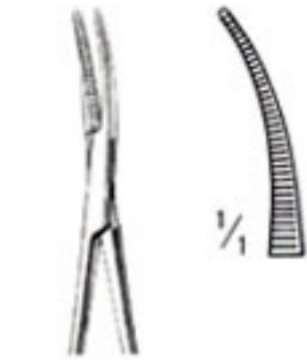

Micro-Mosquito

1-321-10 = 10 cm / 4"

1-321-12 = 12 cm / 4 3/4"

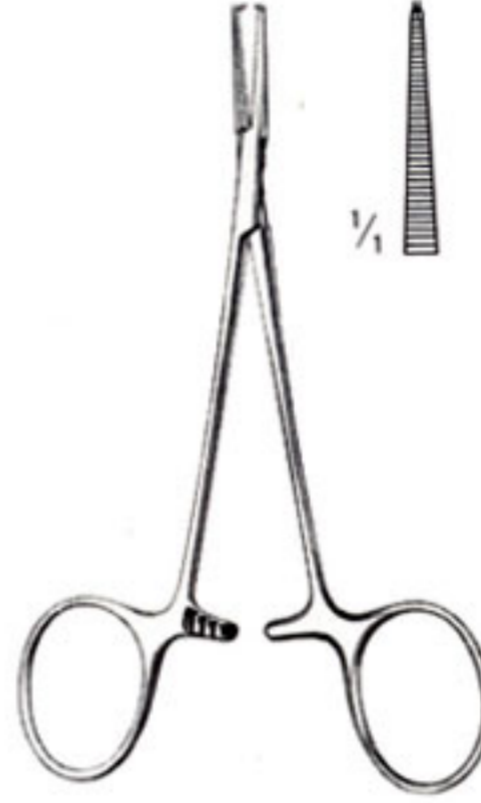

Micro-Mosquito

1-322-10 = 10 cm / 4"

1-322-12 = 12 cm / 4 3/4"

1:2 Zähne · Teeth · Dientes

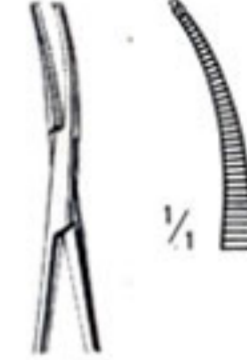

Micro-Mosquito

1-323-10 = 10 cm / 4"

1-323-12 = 12 cm / 4 3/4"

1:2 Zähne · Teeth · Dientes



1-324-14

Providence-Hospital

14 cm / 5 1/2"

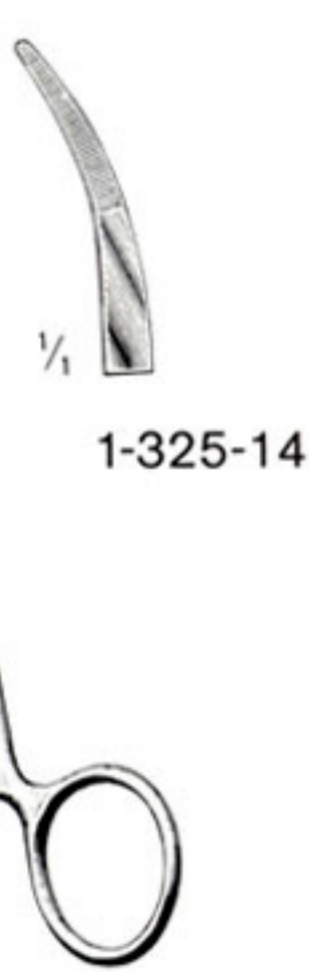

1-325-14

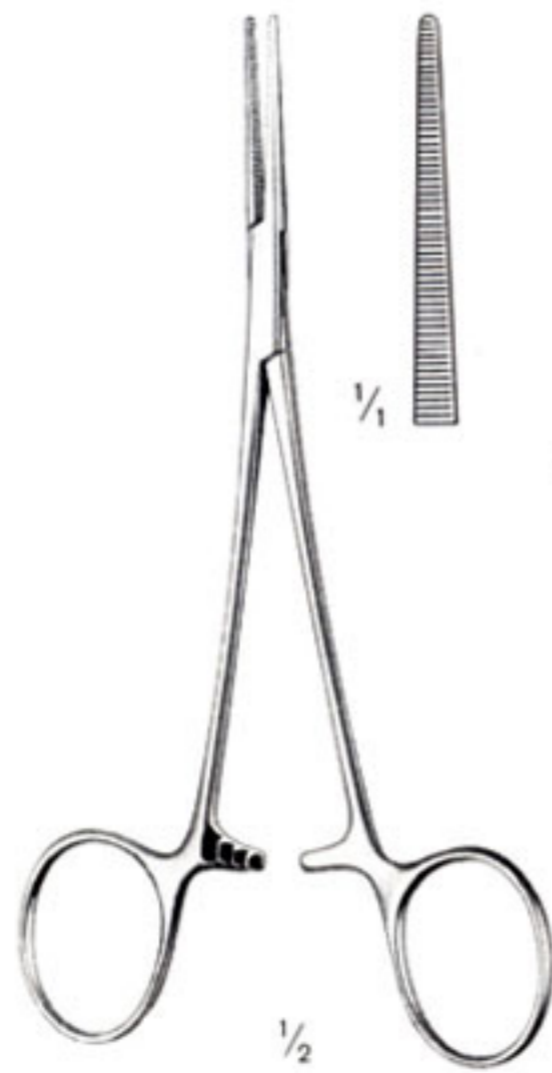

Leriche

1-326-15

15 cm / 6"



1-327-15

15 cm / 6"



Leriche

1-328-15

15 cm / 6"

1:2 Zähne · Teeth · Dientes

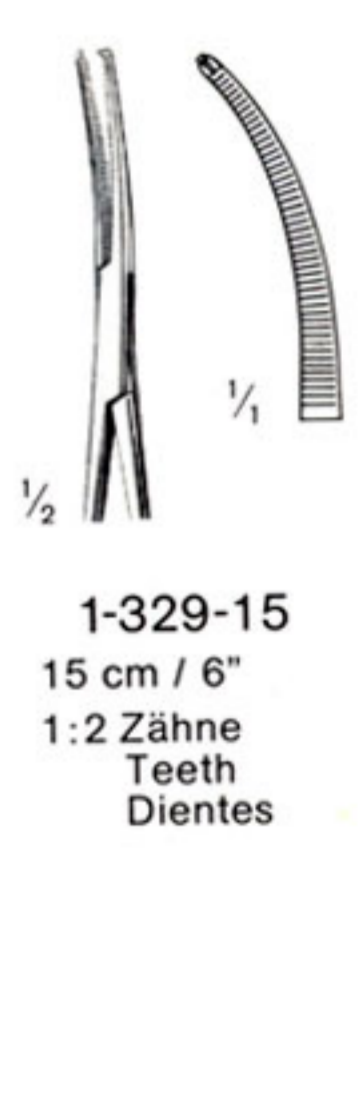

1-329-15

15 cm / 6"

1:2 Zähne

Teeth

Dientes

Arterienklemmen

Artery Forceps

Pinzas hemostaticas

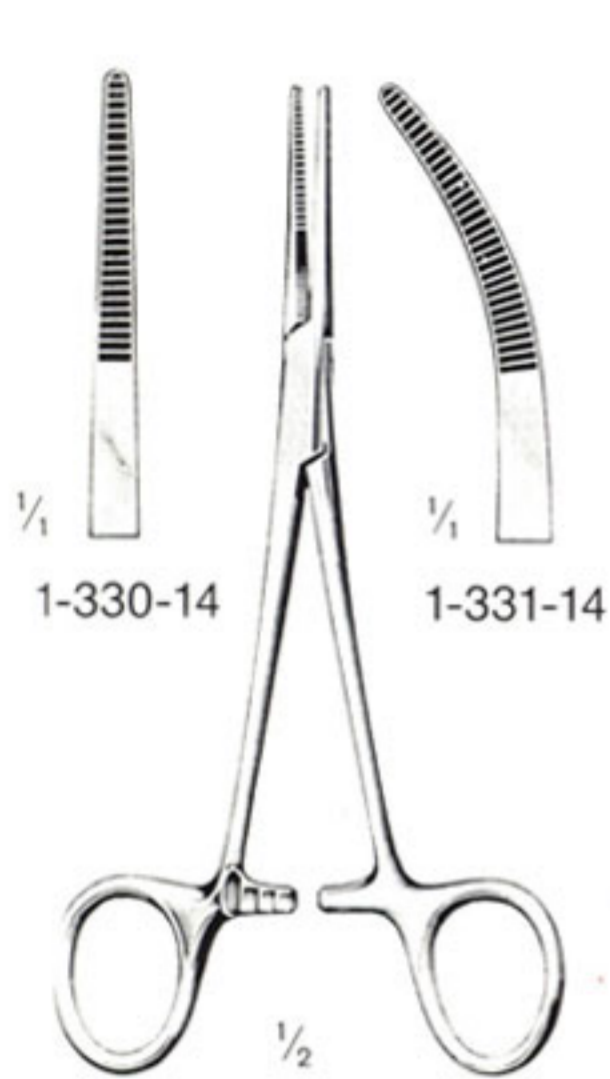

Kelly
14 cm / 5 1/2"

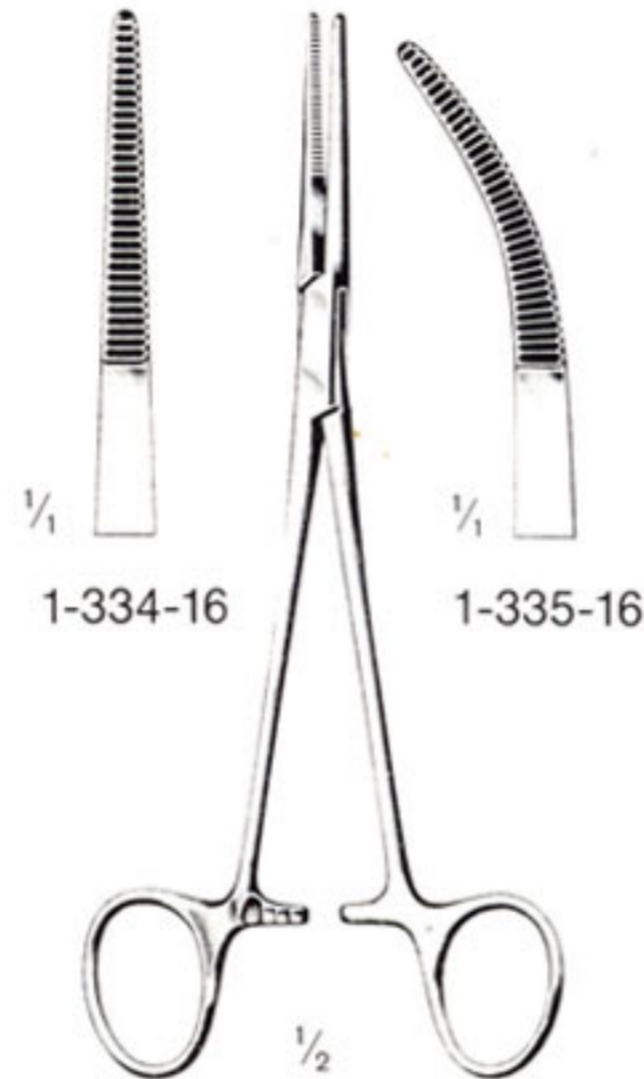

Kelly-Rankin
16 cm / 6 1/4"

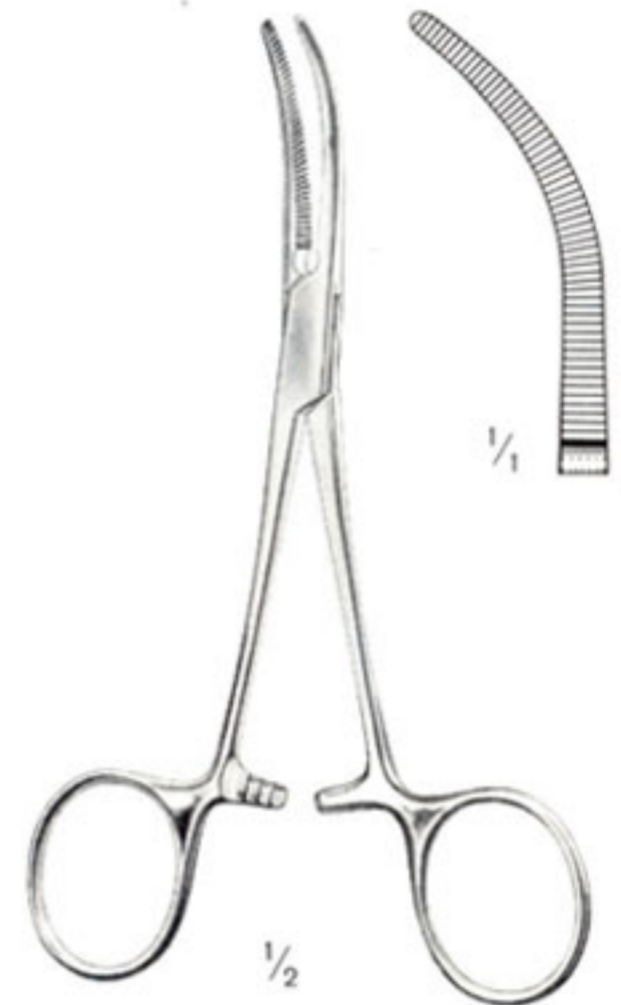

Baby-Overholt
1-339-14
13,5 cm / 5 1/4"

Maul kreuzgerieft
cross serrations
bocas con estrías cruzadas

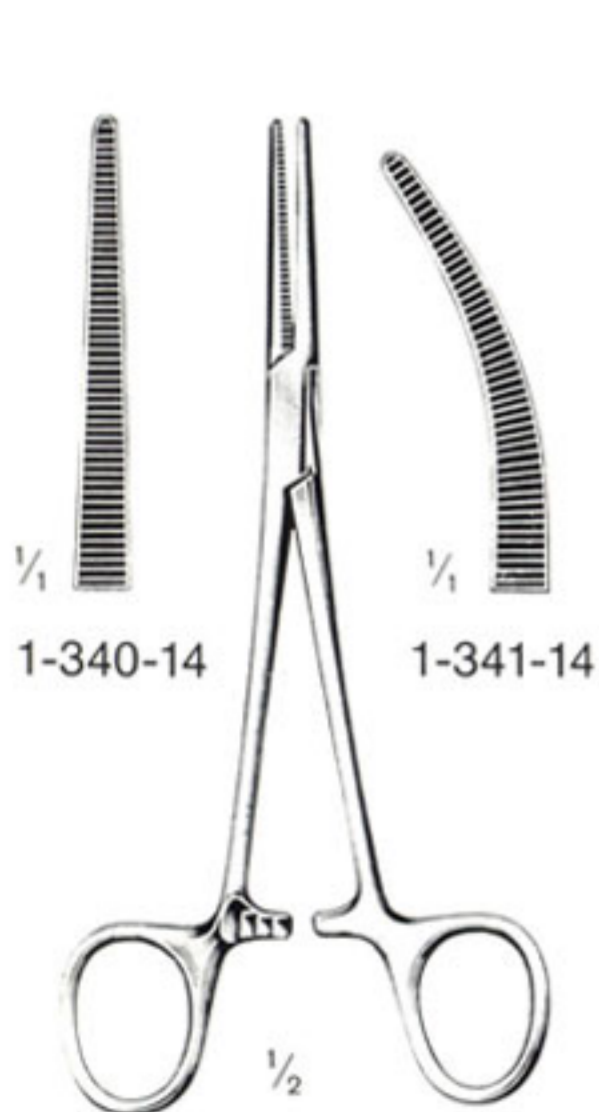

Crile
14 cm / 5 1/2"

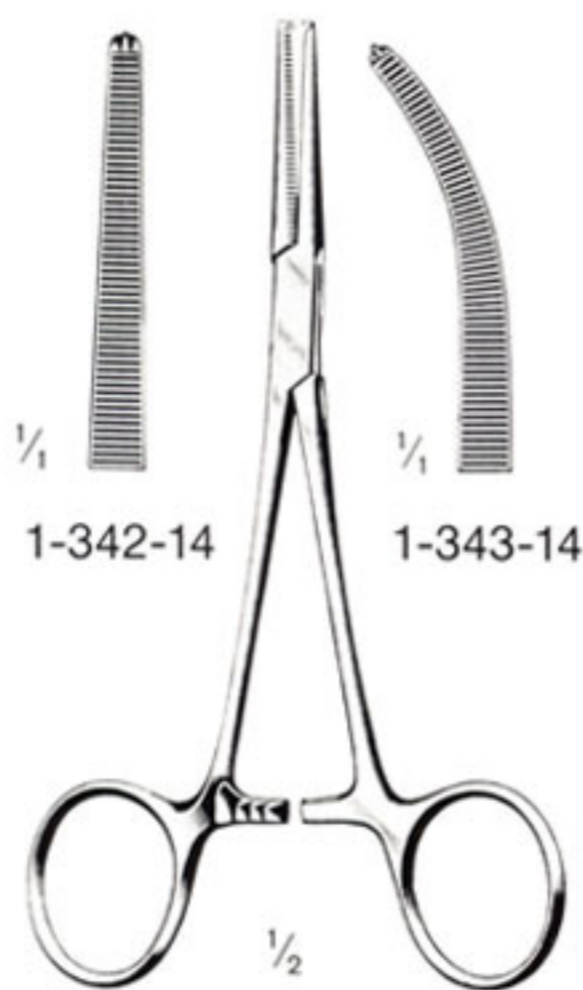

Crile
14 cm / 5 1/2"
1 : 2

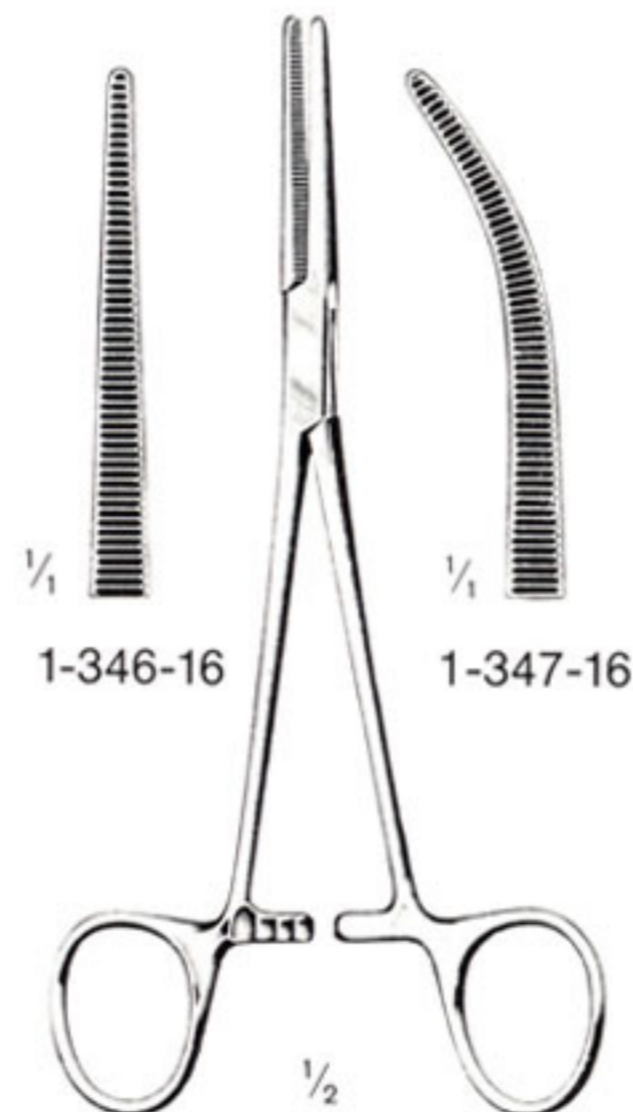

Crile-Rankin
16 cm / 6 1/4"

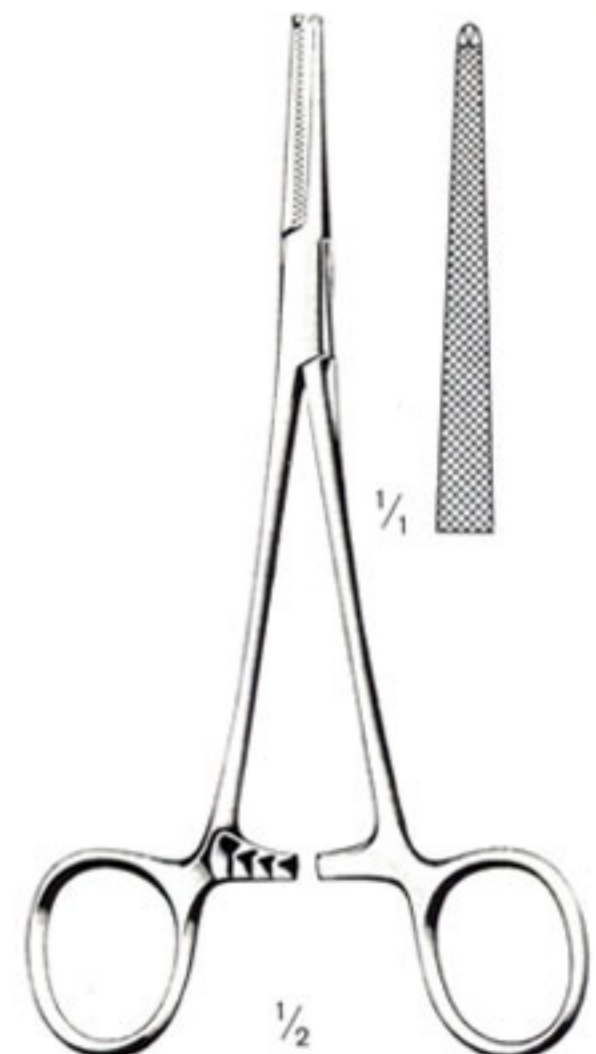

Lovlace
1-350-15
15,5 cm / 6"
1 : 2

Arterienklemmen

Artery Forceps

Pinzas hemostaticas

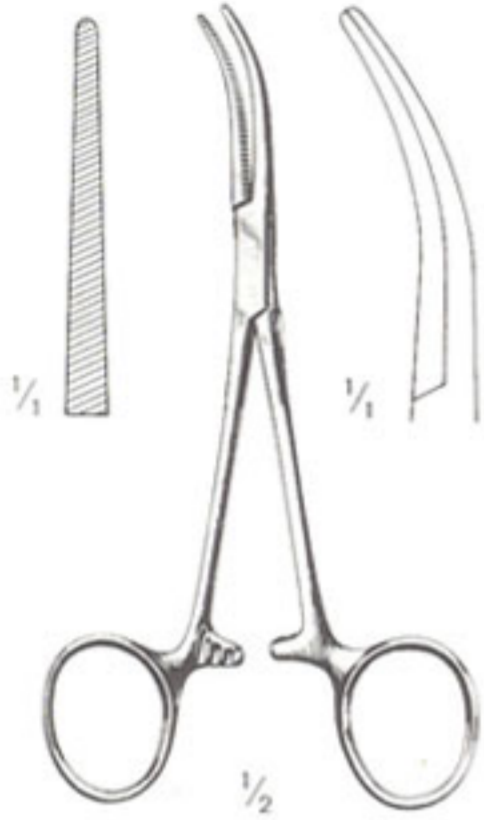

Mosquito-Dandy
1-351-12
12 cm / 4 3/4"

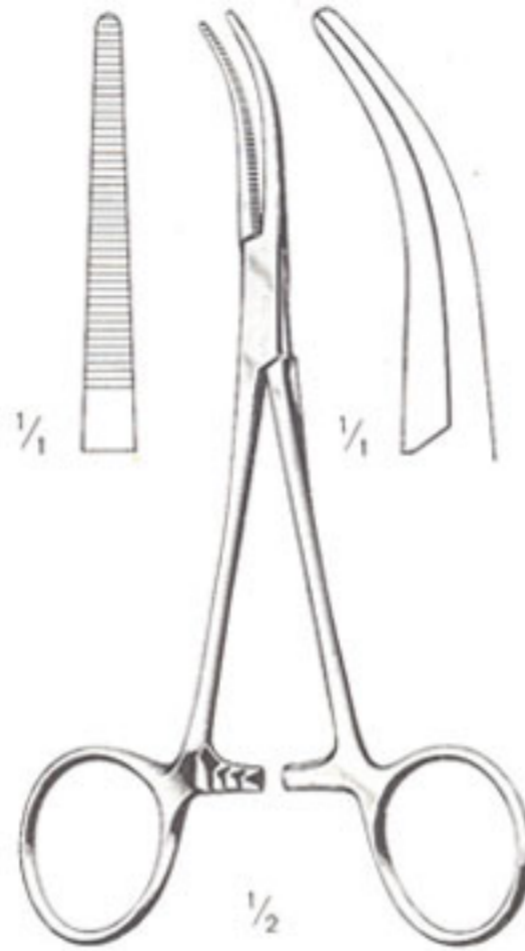

Dandy
1-355-14
14 cm / 5 1/2"

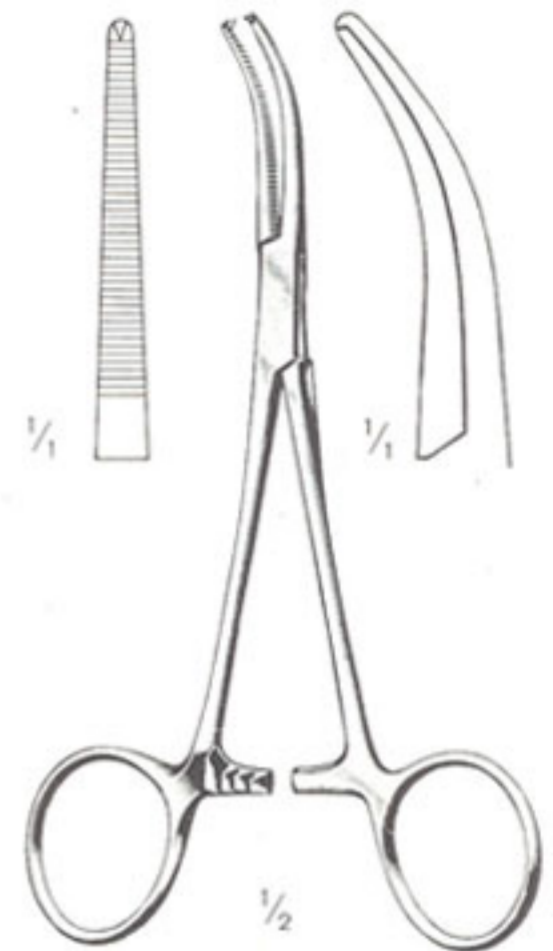

Dandy
1-357-14
1 : 2 Zähne · Teeth · Dientes

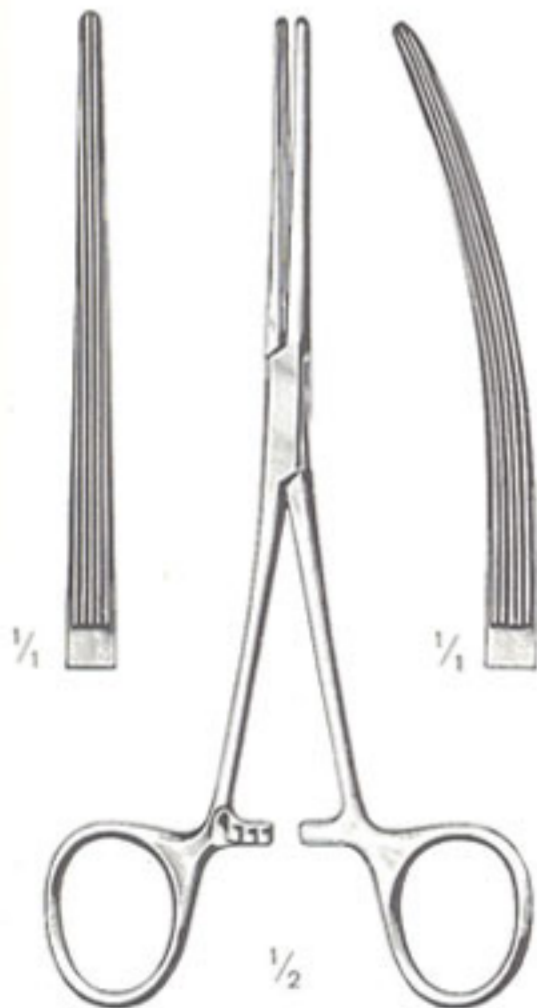

Bainbridge

gerade straight rectas	cm	in.	gebogen curved curvas
1-358-15	15,0	6	1-359-15
1-358-18	18,5	7 1/4	1-359-18



Schnidt
19 cm / 7 1/2"

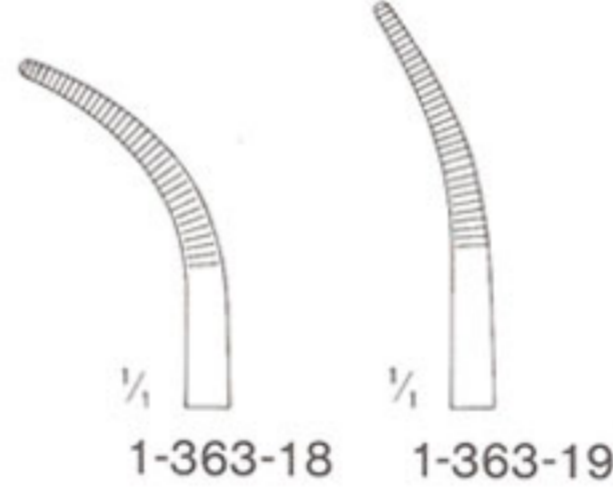

1-363-18

1-363-19

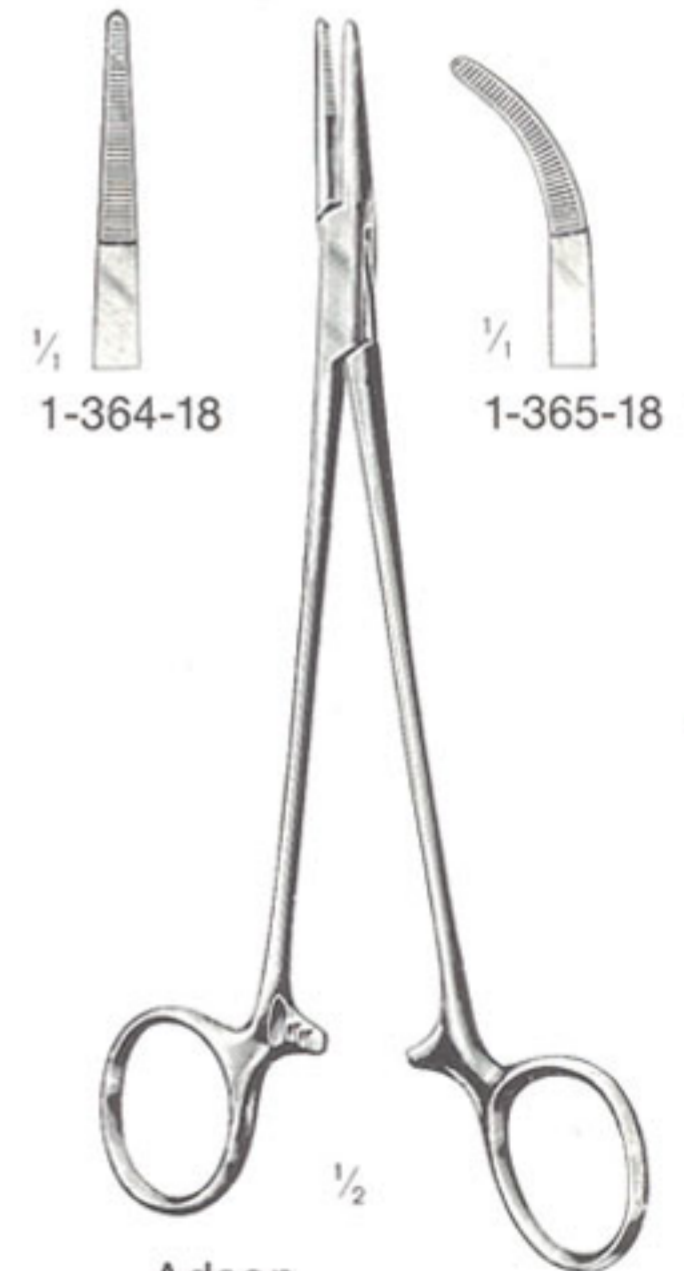

Adson
18,5 cm / 7 1/4"

Arterienklemmen

Artery Forceps

Pinzas hemostaticas

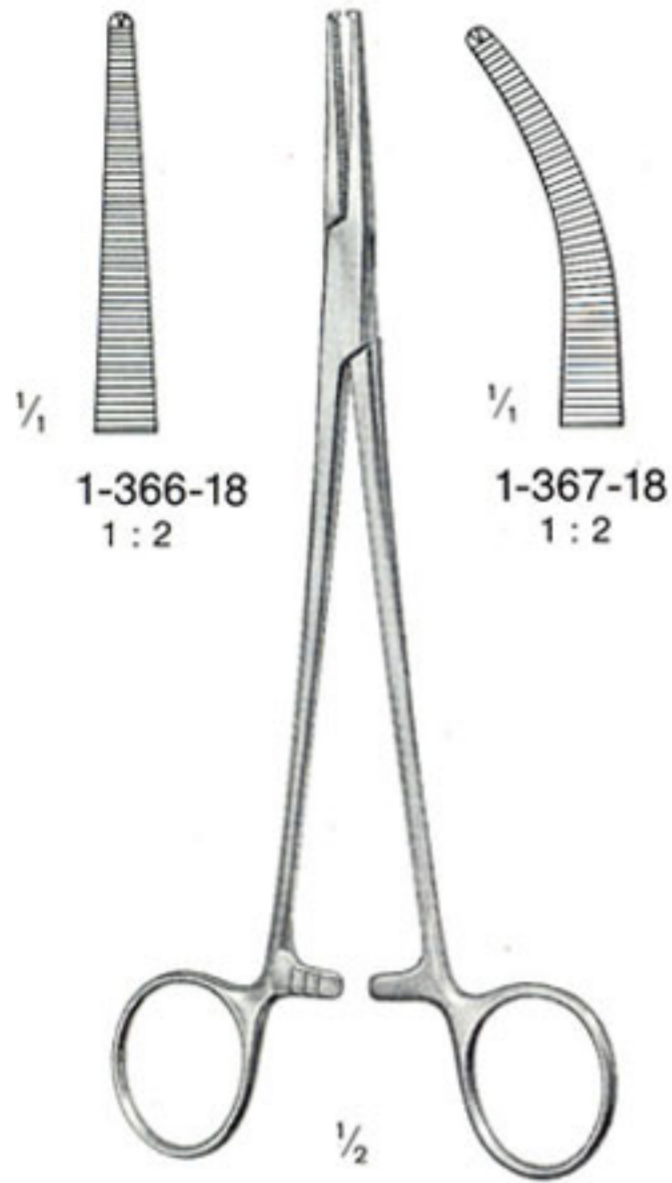

Adson
18,5 cm / 7 1/4"

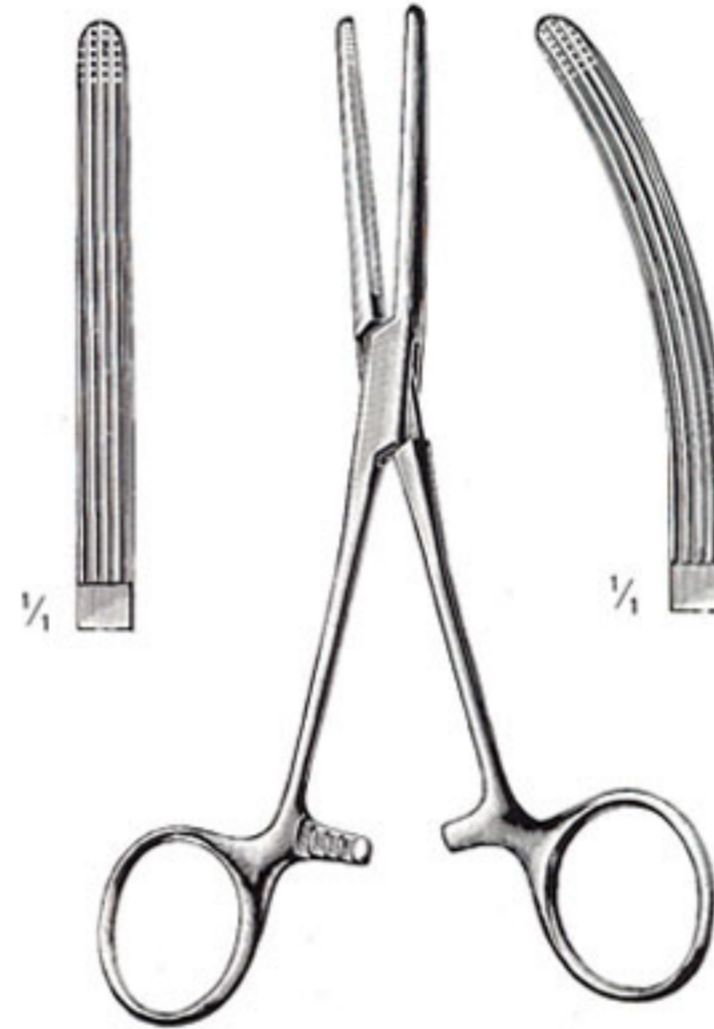

Rochester-Carmalt

straight rectas	cm	in.	curved curvas
1-370-16	16	6 1/4	1-371-16
1-370-20	20	8	1-371-20



Péan

straight rectas	cm	in.	curved curvas
1-374-13	13	5	1-375-13
1-374-14	14	5 1/2	1-375-14
1-374-16	16	6 1/4	1-375-16

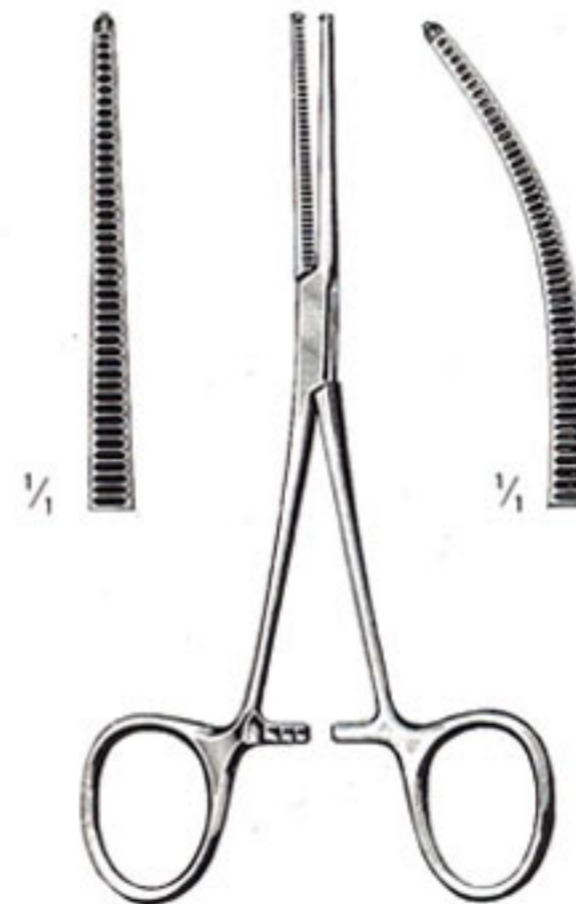

Kocher

straight rectas	1:2		curved curvas
	cm	in.	
1-384-13	13	5	1-385-13
1-384-14	14	5 1/2	1-385-14
1-384-16	16	6 1/4	1-385-16

Arterienklemmen

Artery Forceps

Pinzas hemostaticas

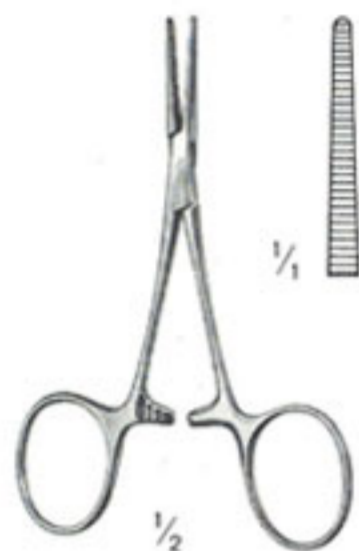

Carrel
1-150-08
8,5 cm / 3 1/2"



Terrier
1-154-08
8,5 cm / 3 1/2"

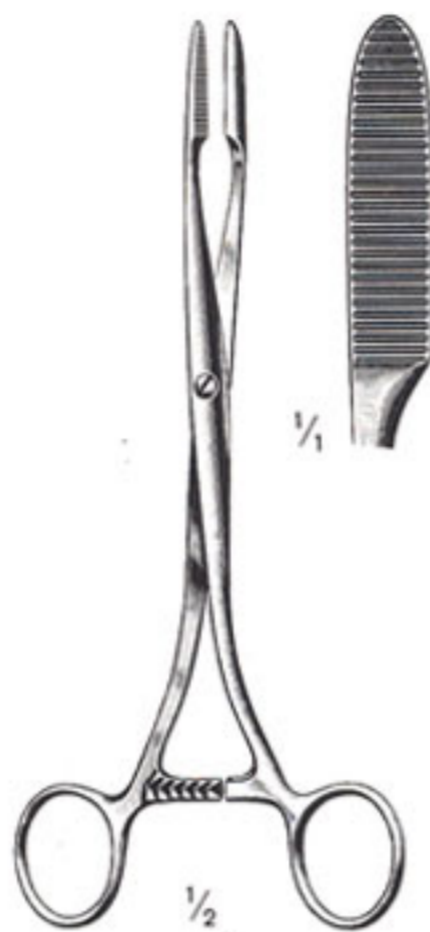

Péan

straight rectas	cm	in.
1-174-18	18,0	7
1-174-20	20,0	8

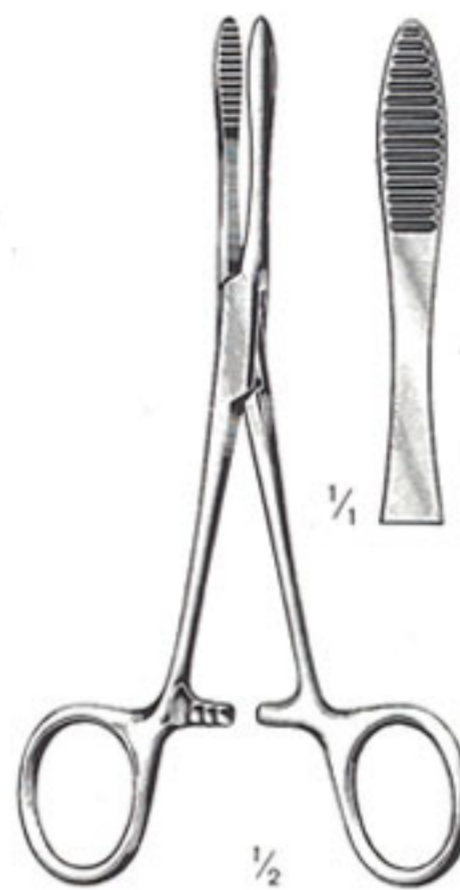

Péan
14 cm / 5 1/2" = 1-176-14
16 cm / 6 1/4" = 1-176-16

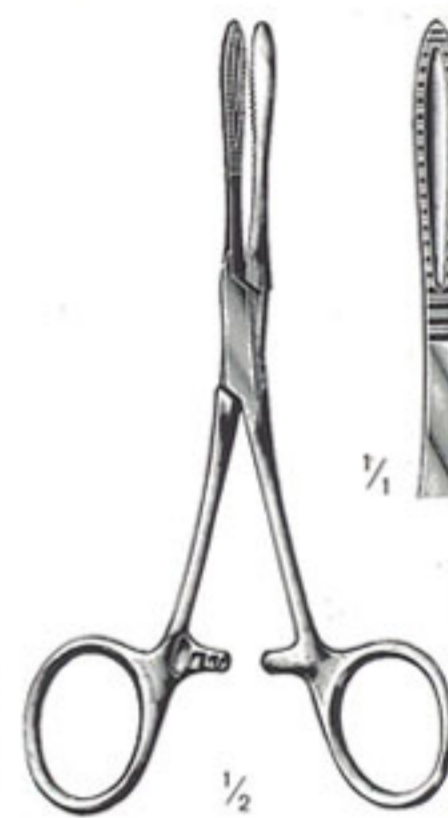

Kroenlein
1-182-13
13 cm / 5"



Péan



straight rectas	cm	in.	curved curvas
1-200-18	18	7	1-201-18
1-200-20	20	8	1-201-20
1-200-22	22	8 3/4	1-201-22
1-200-24	24	9 1/2	1-201-24
1-200-26	26	10 1/4	1-201-26
1-200-28	28	11	1-201-28

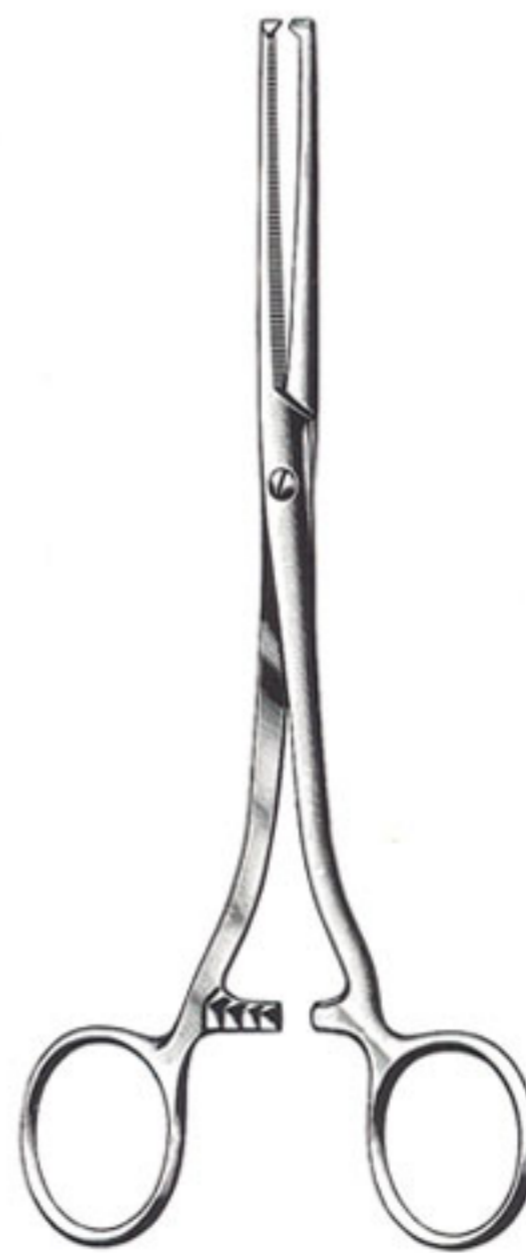

Kocher



straight rectas	cm	in.	curved curvas
1-220-18	18,0	7	1-221-18
1-220-20	20,0	8	1-221-20
1-220-22	22,0	8 3/4	1-221-22
1-220-24	24,0	9 1/2	1-221-24
1-220-26	26,0	10 1/4	1-221-26

Arterienklemmen

Artery Forceps

Pinzas hemostaticas

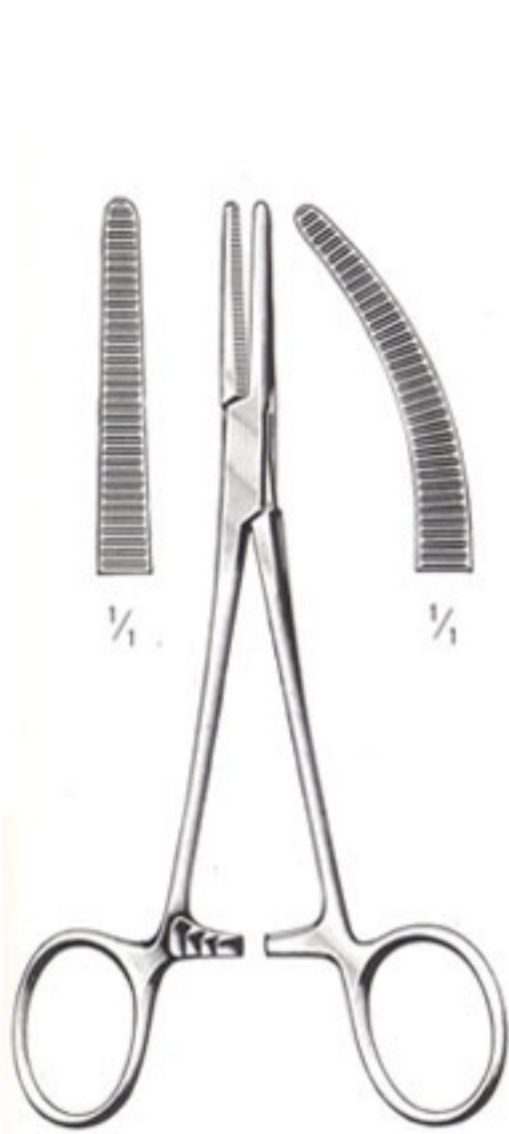

Spencer-Wells/Jones

	gerade straight rectas		gebogen curved curvas	
	cm	in.	cm	in.
1-248-13	13,0	5	1-249-13	
1-248-14	14,0	5½	1-249-14	
1-248-15	15,5	6	1-249-15	



Spencer-Wells

	gerade straight rectas		gebogen curved curvas	
	cm	in.	cm	in.
1-248-18	18,0	7	1-249-18	
1-248-20	20,0	8	1-249-20	

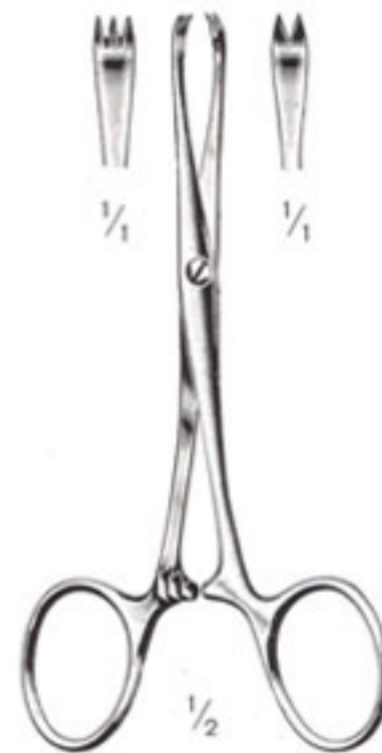

Chaput
1-256-13
13 cm / 5"

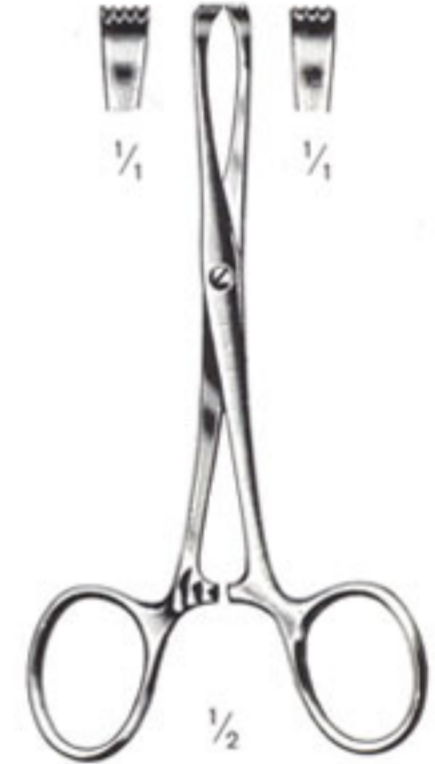

Tuffier
1-258-13
13 cm / 5"

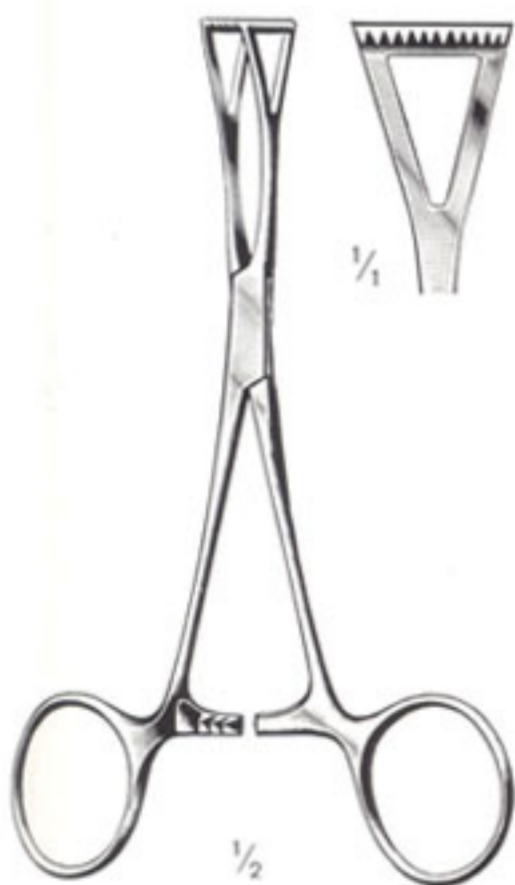

Collin
1-268-14
14 cm / 5½"



Collin
1-270-16
16 cm / 6¼"



Collin
1-278-17
16,5 cm / 6½"

Arterienklemmen

Artery Forceps

Pinzas hemostaticas



Pennington
 15,5 cm/6" = 1-280-15
 20 cm/8" = 1-280-20

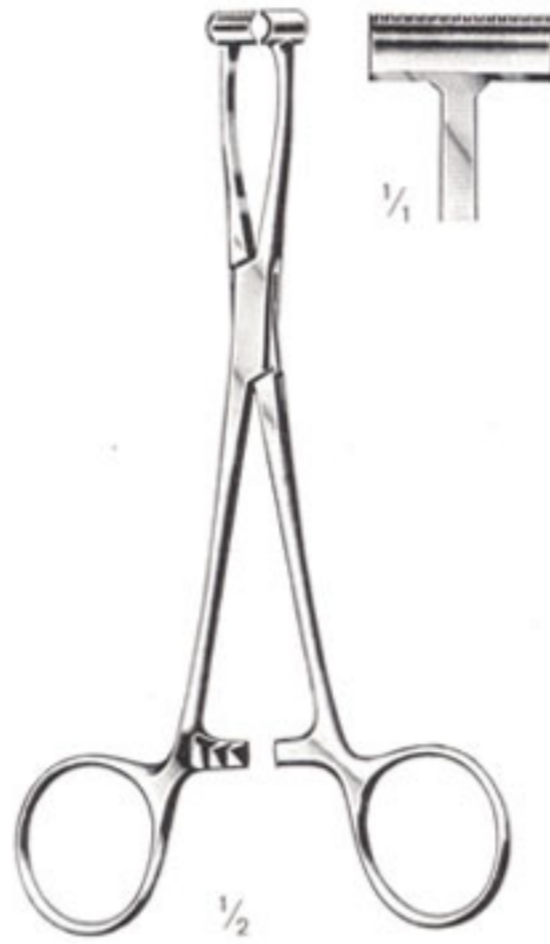

Pratt
 1-282-15
 15 cm/6"



Martel
 1-290-14
 14 cm/5 1/2"



Willet-Martel
 1-292-19
 19 cm/7 1/2"

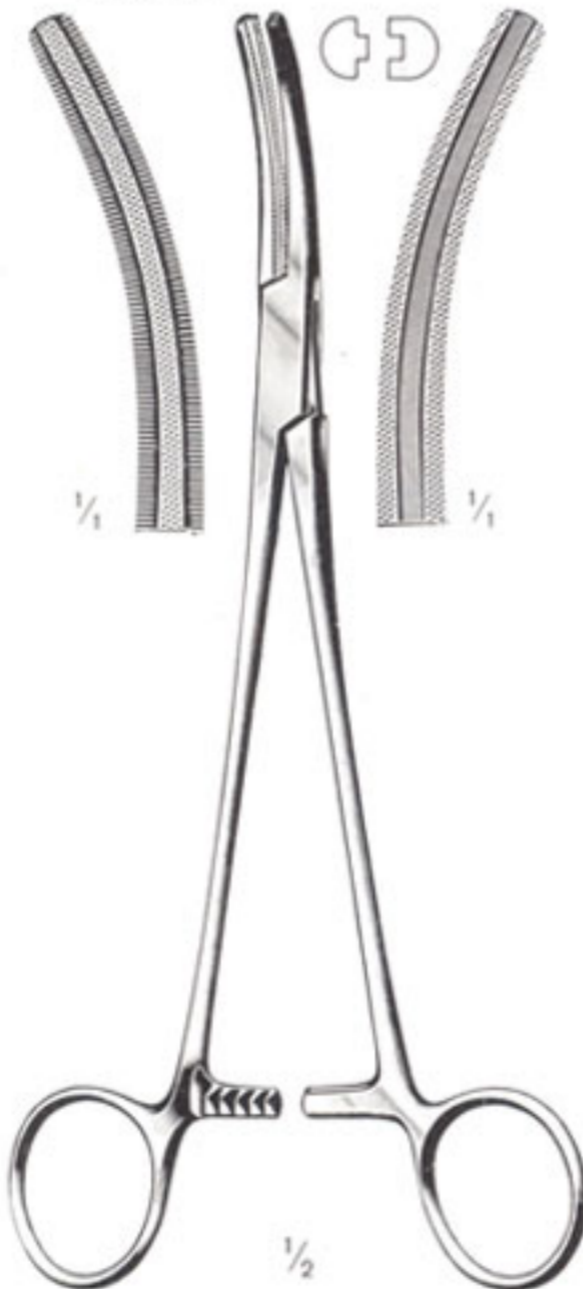

Buie
 1-297-21
 21 cm/8 1/4"

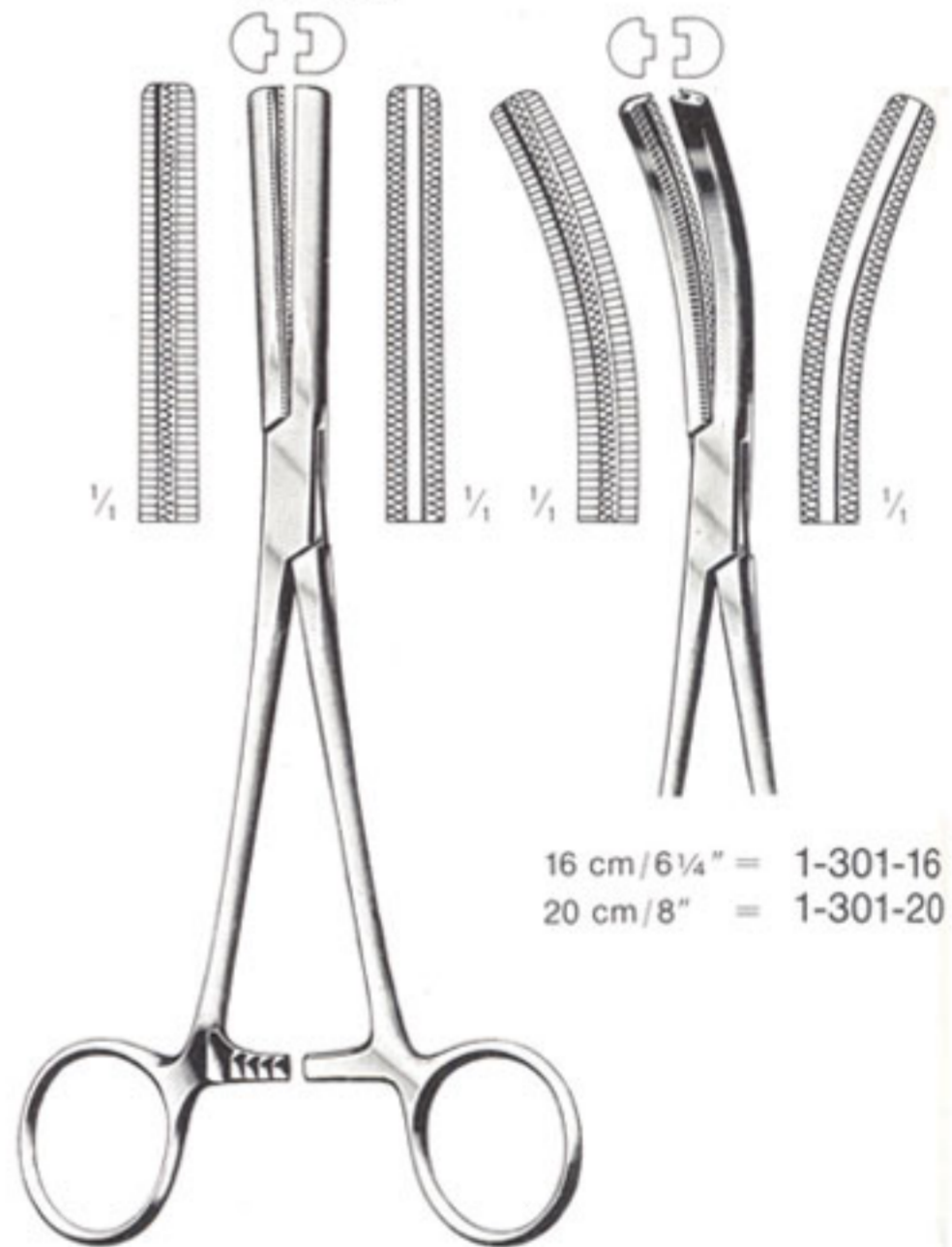

16 cm/6 1/4" = 1-301-16
 20 cm/8" = 1-301-20

Fergusson
 16 cm/6 1/4" = 1-300-16
 20 cm/8" = 1-300-20

1-282-15

1-290-14- 1-292-19
 1-297-21- 1-301-20

- Artery and Haemorrhoidal (Pile) Clamps
- Scalp Flap Forceps
- Angiotribes and Haemorrhoidal (Pile) Forceps

Arterienklemmen

Artery Forceps

Pinzas hemostaticas

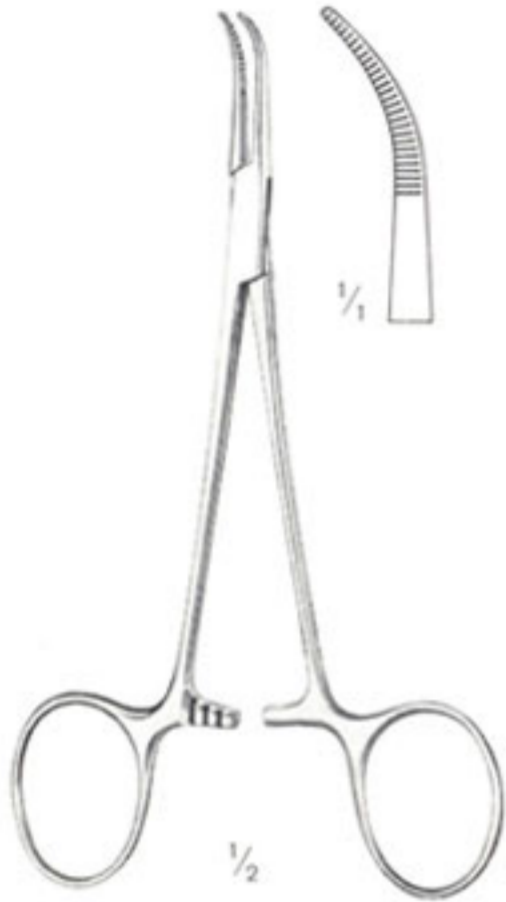

Baby-Mixer
1-303-01
14 cm / 5½"

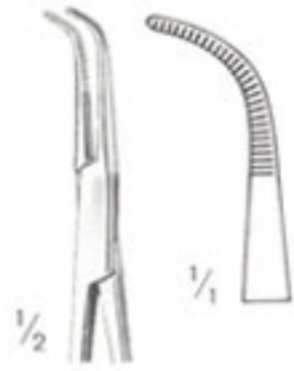

1-303-02
14 cm / 5½"



Barraquer
1-305-12
12 cm / 4¾"



1-305-18
18,5 cm / 7¼"



1-305-19
19 cm / 7¾"



Hartmann
1-306-10
10 cm / 4"

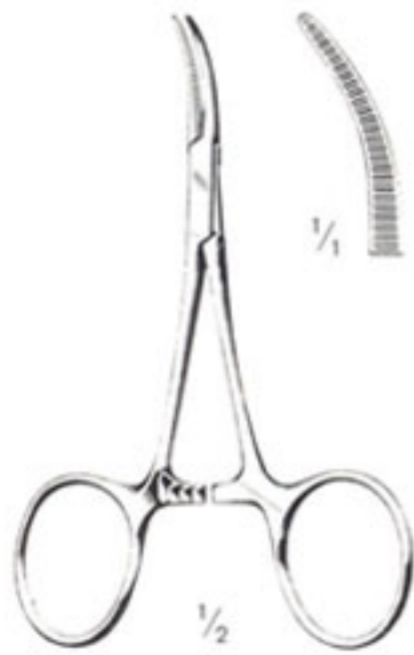

Hartmann
1-307-10
10 cm / 4"

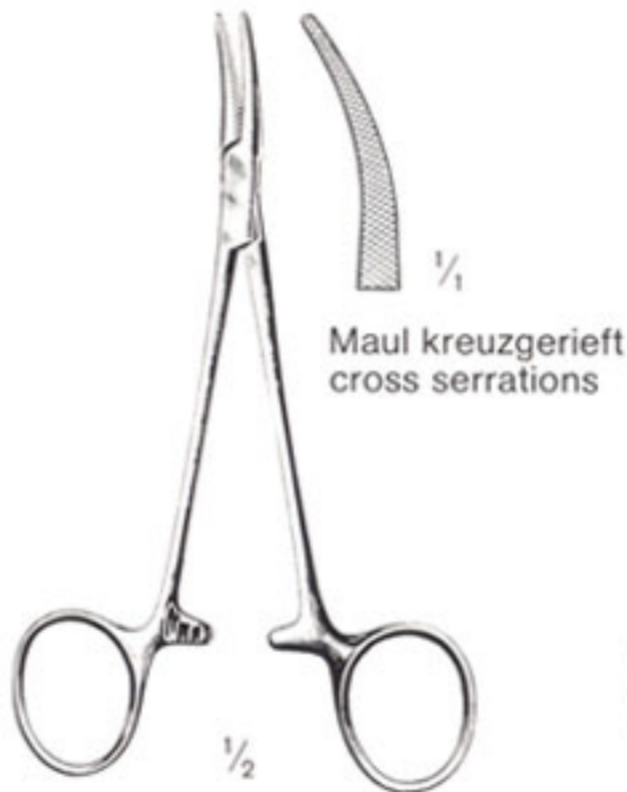

1-309-12
12 cm / 4¾"

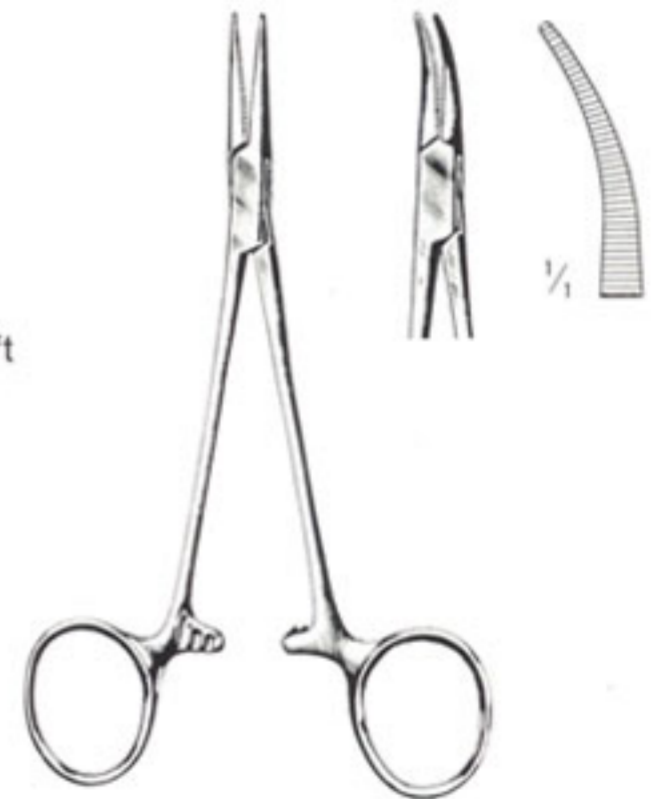

Halsted-Mosquito

straight	cm	in.	curved
1-310-12	12,5	5	1-311-12
1-310-14	14,0	5½	1-311-14

Arterienklemmen

Artery Forceps

Pinzas hemostaticas

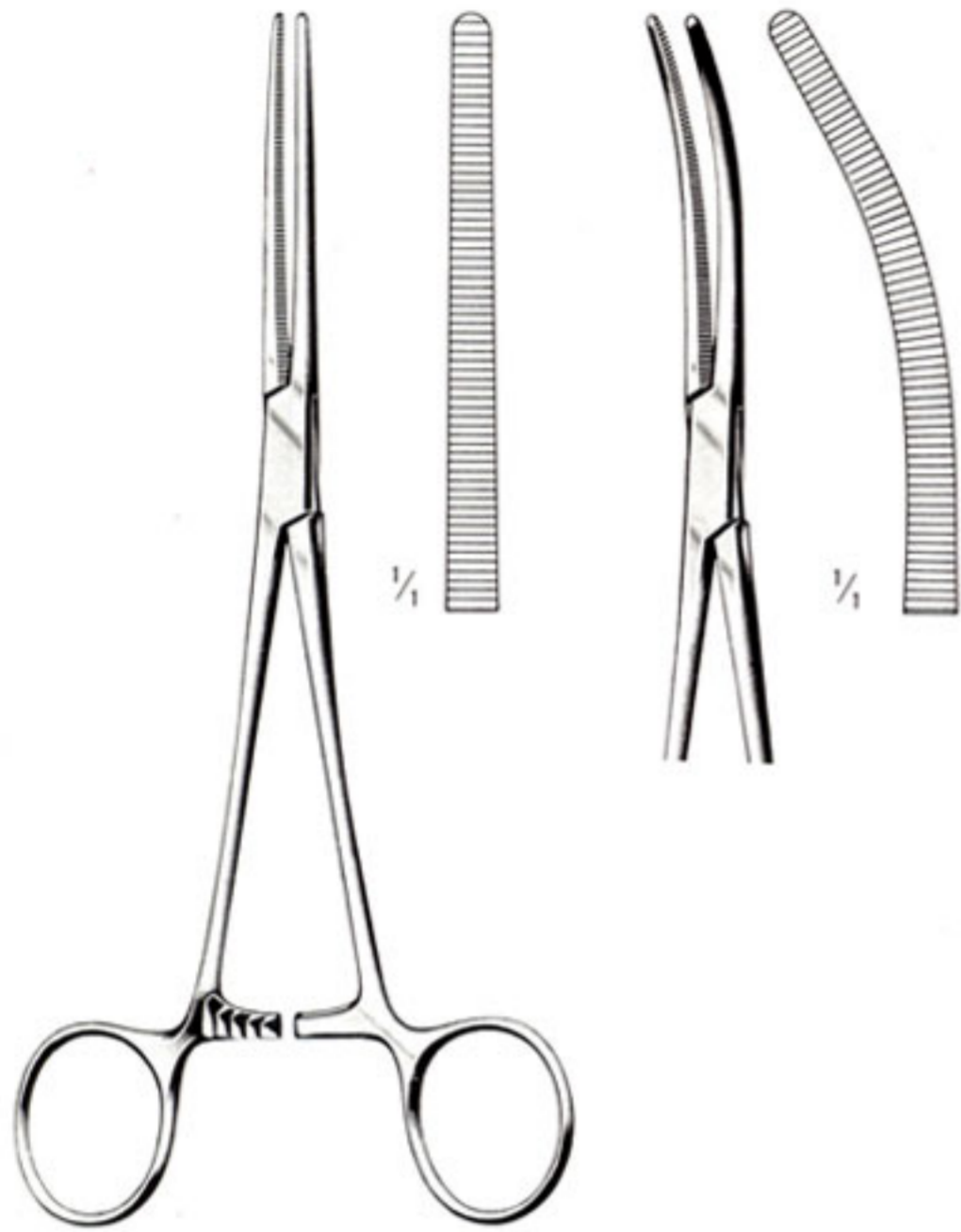

Péan (Rochester)

straight	cm	in.	curved
1-410-14	14	5½	1-411-14
1-410-16	16	6¼	1-411-16
1-410-18	18	7	1-411-18
1-410-20	20	8	1-411-20
1-410-22	22	8¾	1-411-22
1-410-24	24	9½	1-411-24
1-410-26	26	10¼	1-411-26
1-410-30	30	12	1-411-30

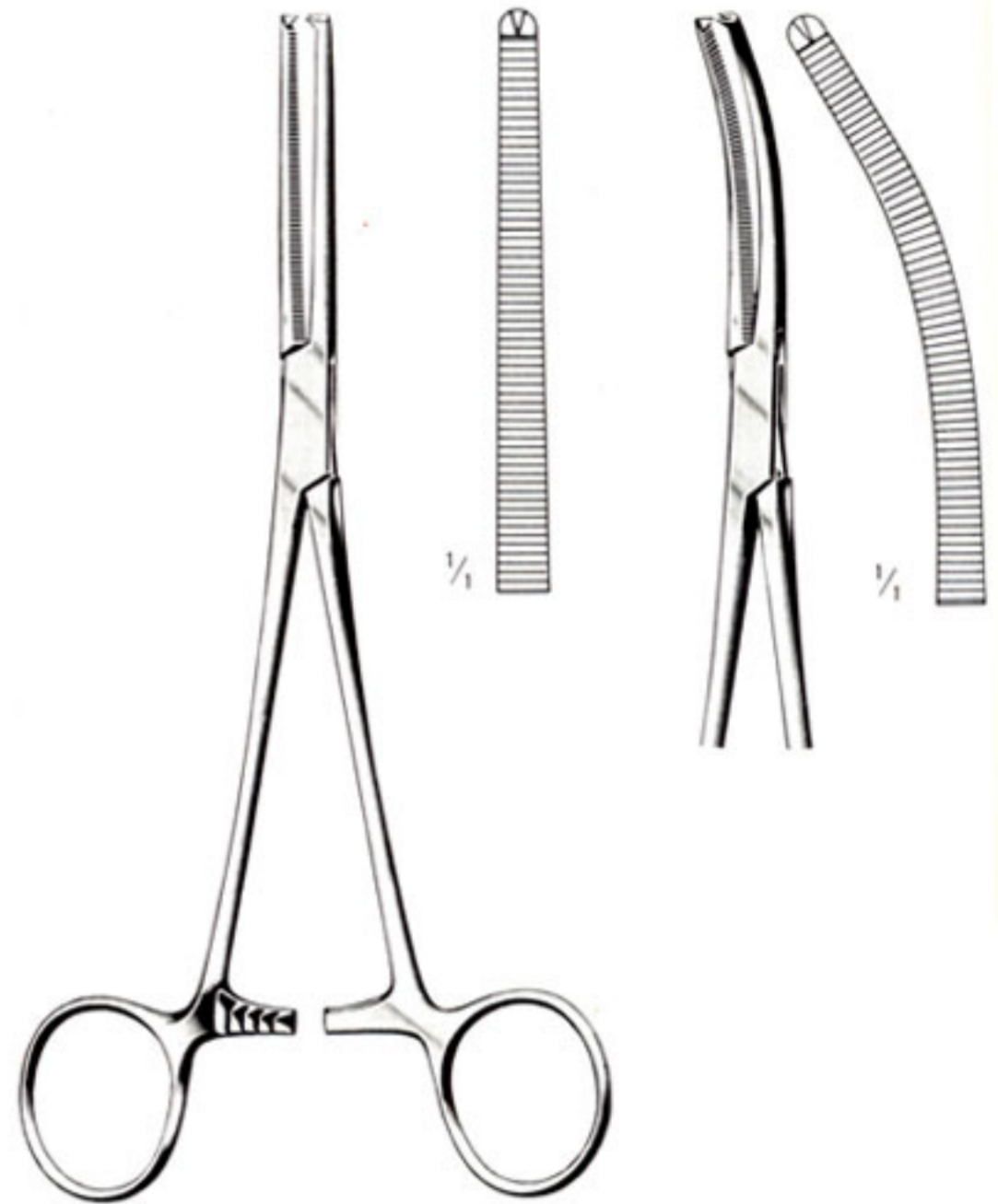

Kocher (Ochsner)

straight	cm	^{1 : 2} in.	curved
1-414-14	14	5½	1-415-14
1-414-16	16	6¼	1-415-16
1-414-18	18	7	1-415-18
1-414-20	20	8	1-415-20
1-414-22	22	8¾	1-415-22
1-414-24	24	9½	1-415-24
1-414-26	26	10¼	1-415-26
1-414-30	30	12	1-415-30

Arterienklemmen

Artery Forceps

Pinzas hemostaticas



Baby-Mixer
1-419-18
18 cm / 7"



Baby-Adson
1-421-14
14 cm / 5 1/2"



Baby-Adson
1-421-18
18 cm / 7"

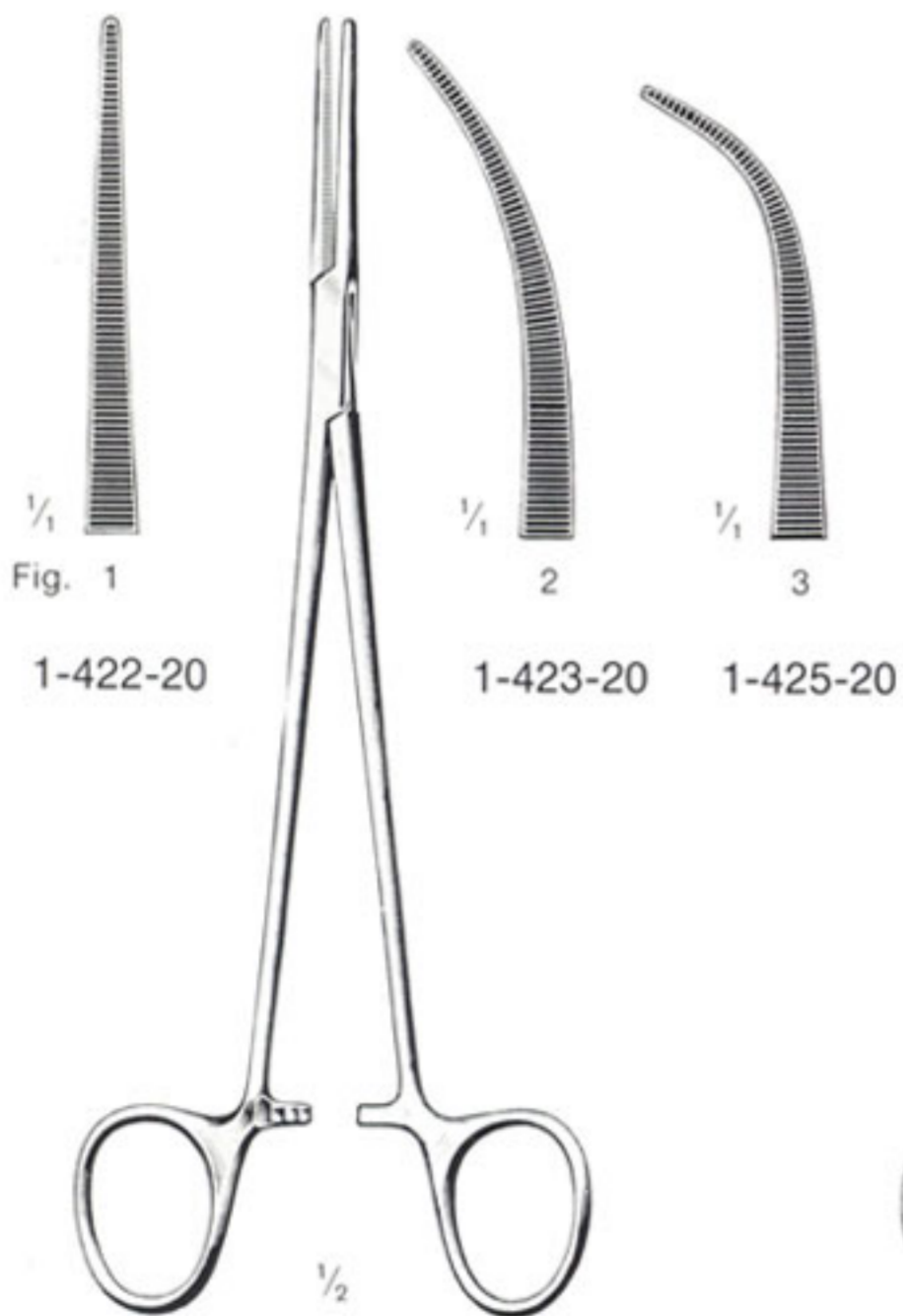

Heiss
20 cm / 8"

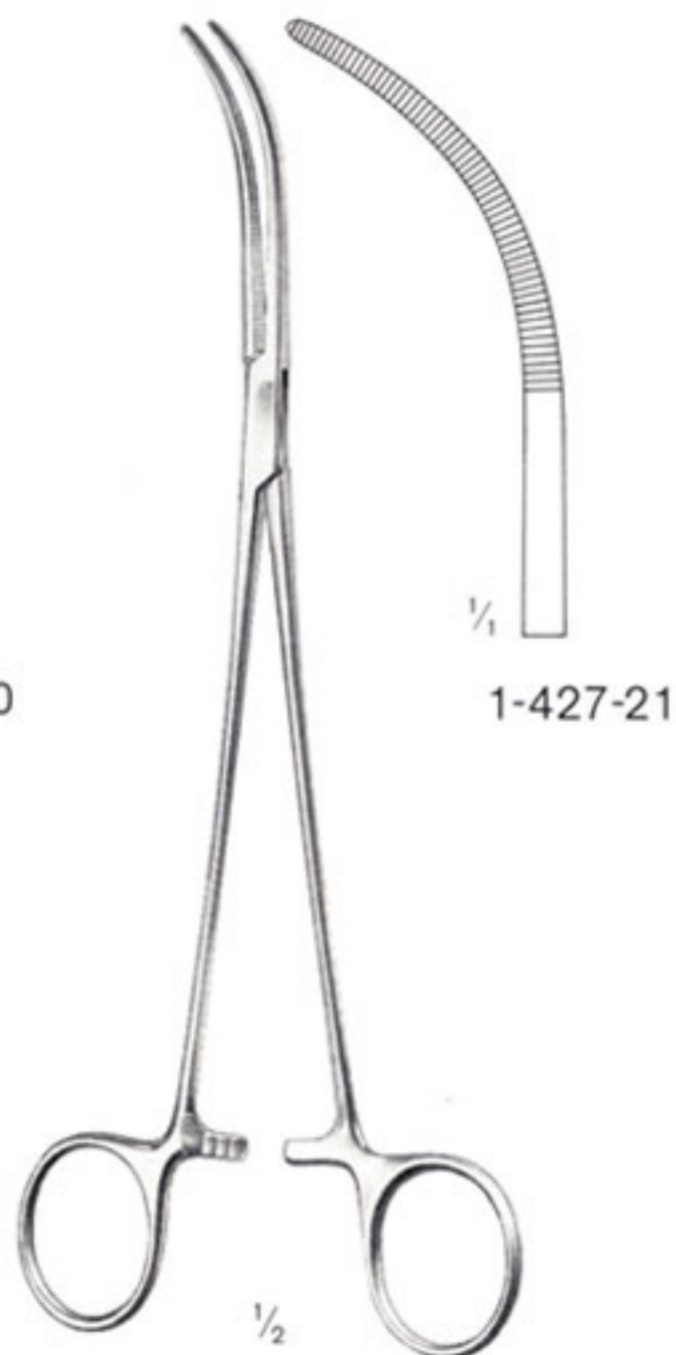

Overholt-Mixer
21 cm / 8 1/4"

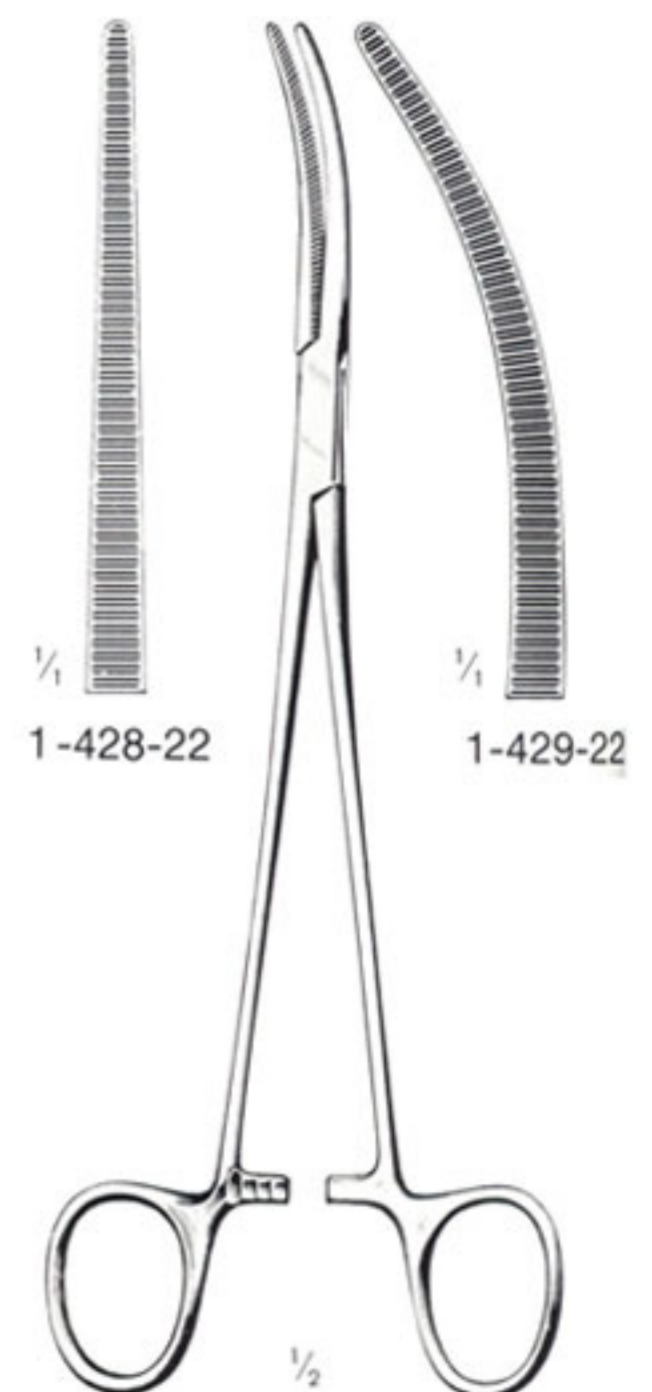

Roberts
22 cm / 8 3/4"

Arterienklemmen

Artery Forceps

Pinzas hemostaticas



Mixer
15,5 cm / 6" = 1-473-15
19 cm / 7 1/2" = 1-473-19

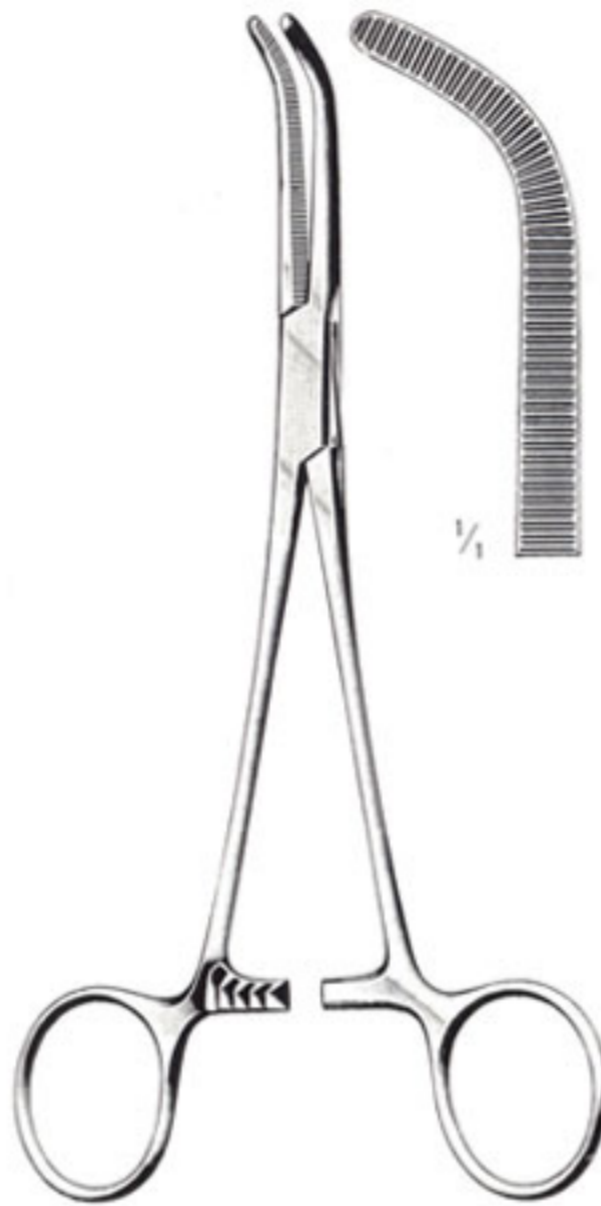

Mixer-O'Shaugnessy
15,5 cm / 6" = 1-479-15
19 cm / 7 1/2" = 1-479-19



Mixer
1-483-22
22 cm / 8 3/4"



Mixer
1-485-23
23 cm / 9"



Mixer

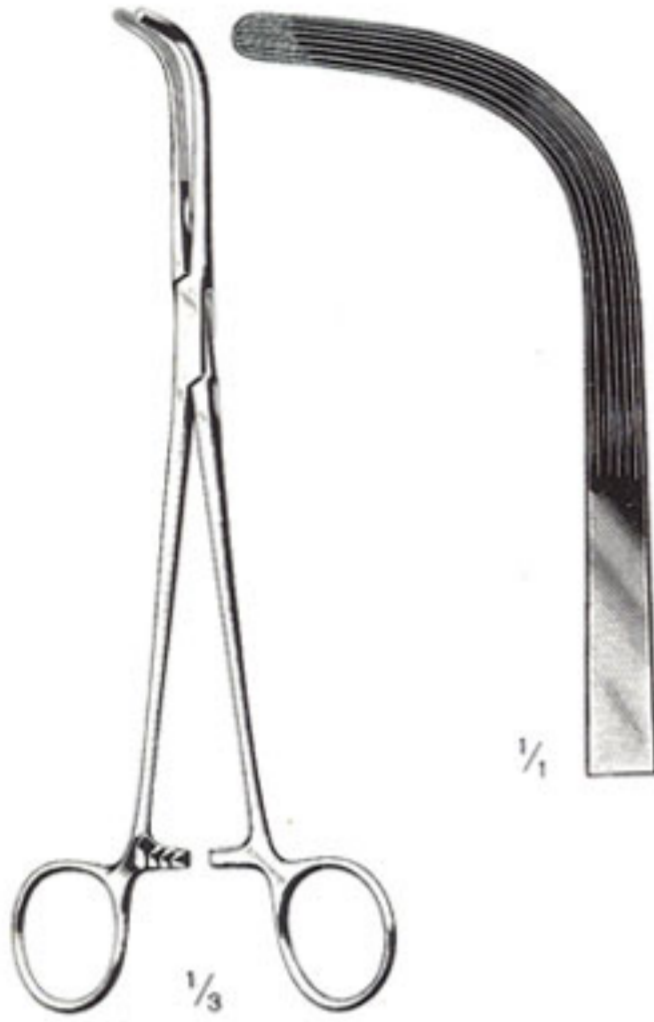

Fig. 1 2 3
1-491-22 1-493-25 1-495-28
22 cm / 8 3/4" 25 cm / 10" 28 cm / 11"

Arterienklemmen

Artery Forceps

Pinzas hemostaticas



McQuigg-Mixer
1-497-22
22 cm / 8 3/4"



Lower
1-501-18
18 cm / 7"

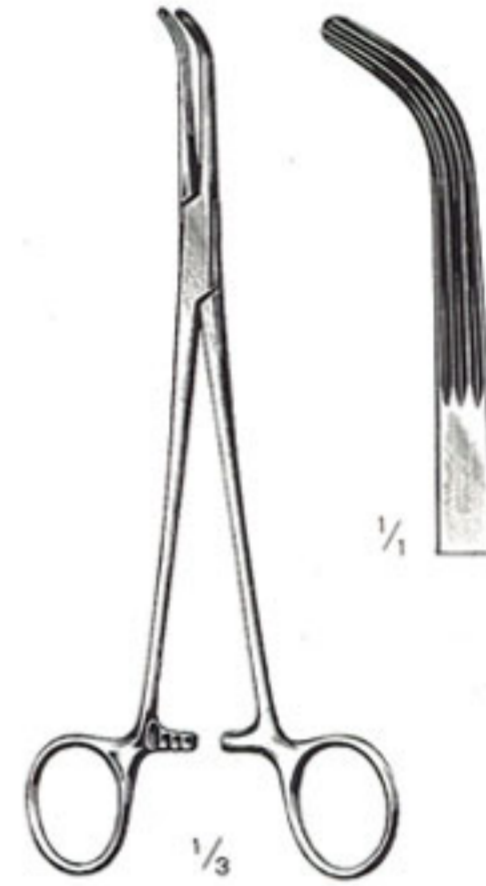

Lahey
1-511-19
19 cm / 7 1/2"

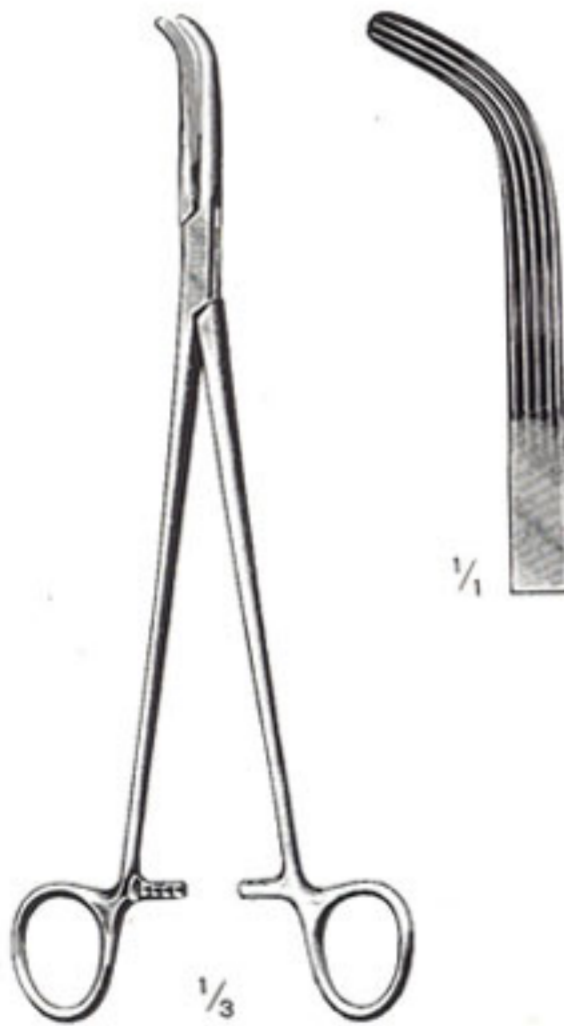

Lahey
1-513-23
23 cm / 9"

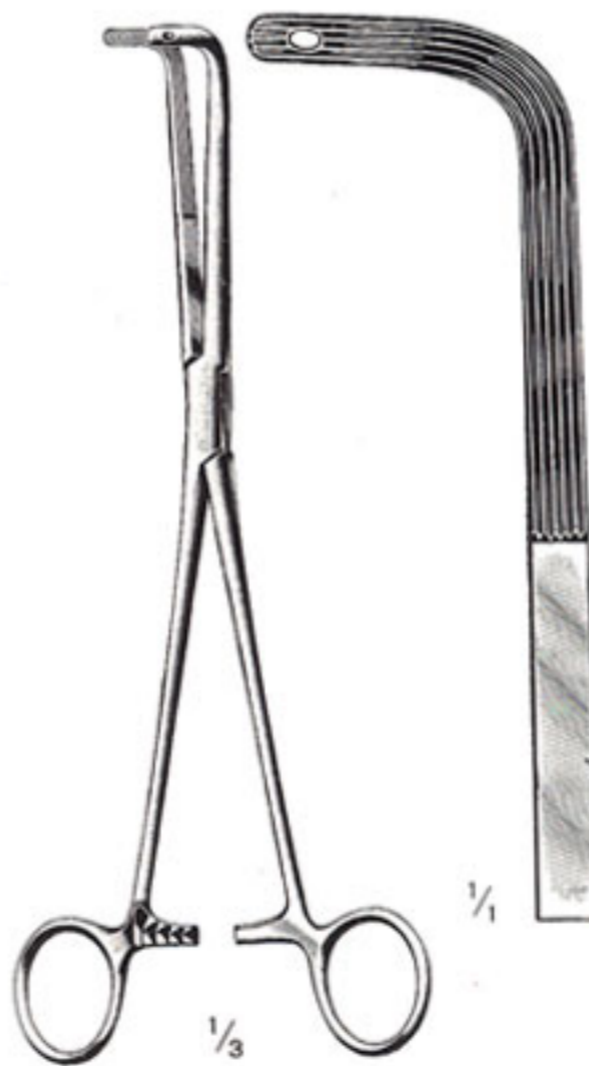

Finocchietto
1-521-24
24 cm / 9 1/2"

Nierenstielklemmen

Kidney Pedical Clamp Forceps

Pinzas-clamps para pedunculos renales

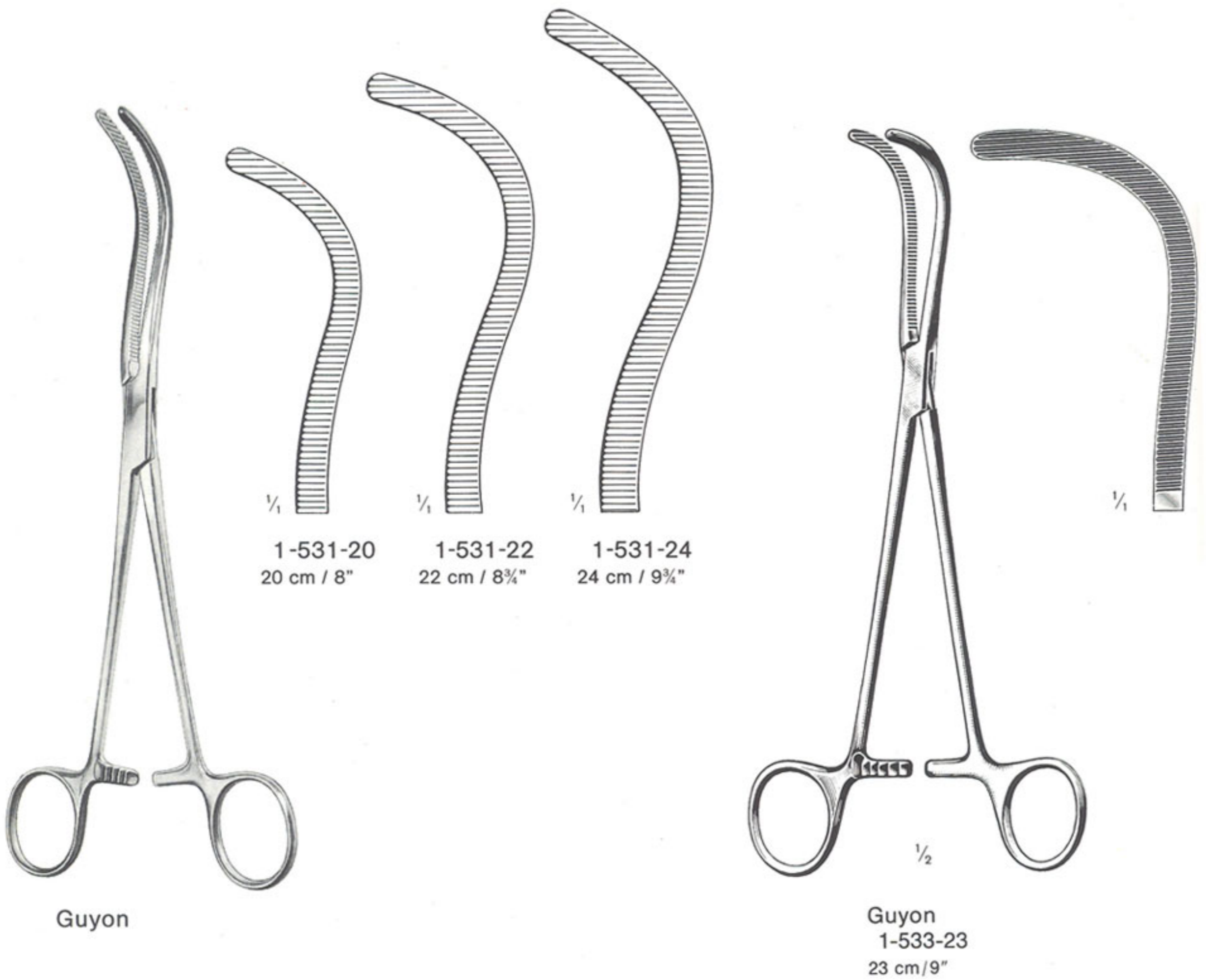

1-531-20 - 1-541-23

Kidney Pedicle Clamps

Nierenstielklemmen

Kidney Pedical Clamp Forceps

Pinzas-clamps para pedunculos renales



Stille
1-537-23
23 cm/9"

1-545-23- 1-549-23

Mayo
1-541-23
23 cm/9"
Kidney Pedicle Clamps

Mayo-Guyon
1-545-23
23 cm/9"

Herrick
1-549-23
23 cm/9"

Gallenkanalkemmen

Gall Duct Clamps

Pinzas para conducto biliar



Gray

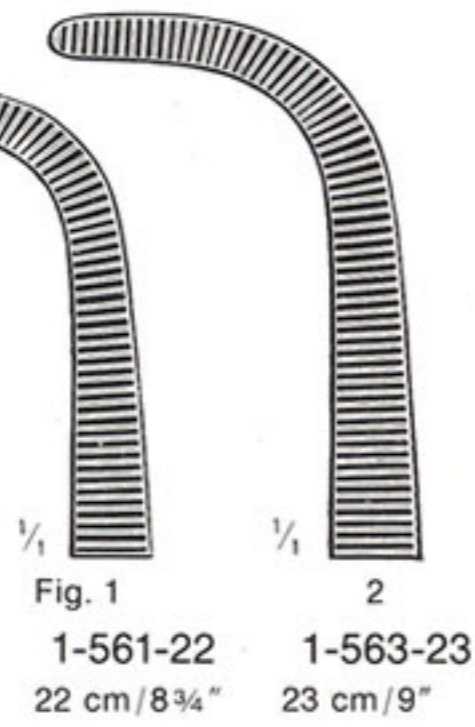

Gray
1:2

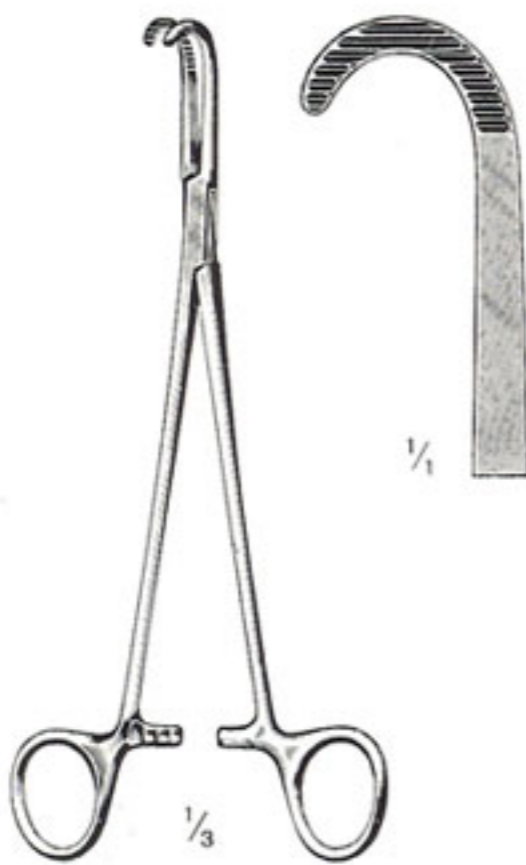
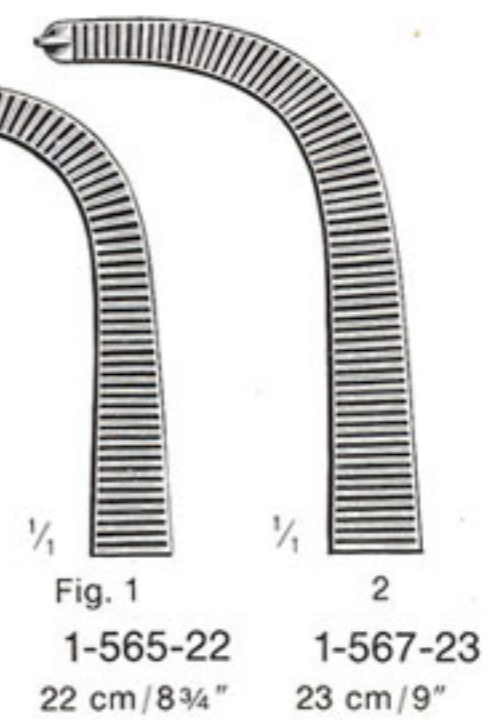

Desjardins
1-571-21
21 cm/8 1/4"

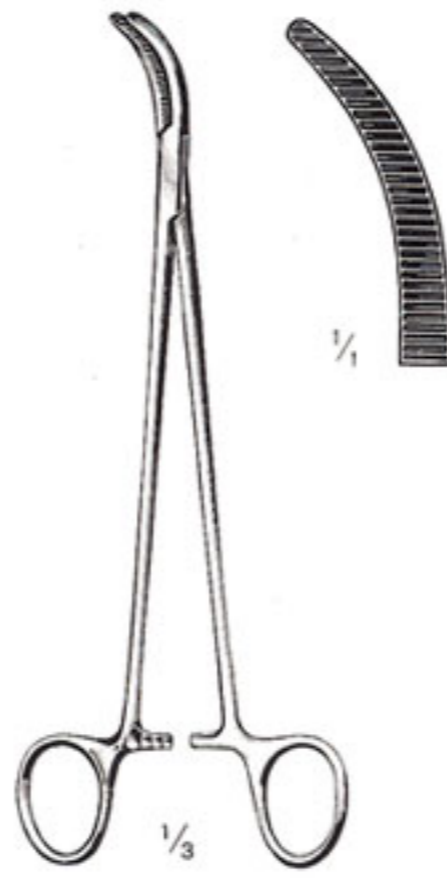

Desjardins
1-573-21
21 cm/8 1/4"

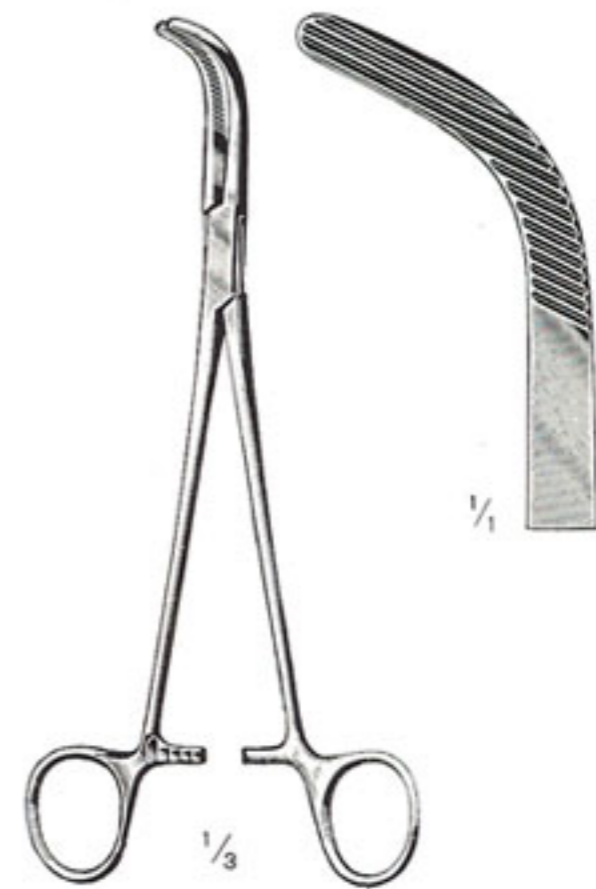

Crile
1-575-20
20 cm/8"

Gallenkanalkemmen

Gall Duct Clamps

Pinzas para conducto biliar



Dean-Shallcross
1-587-18
18 cm / 7"



Hosemann
21 cm / 8 1/4"

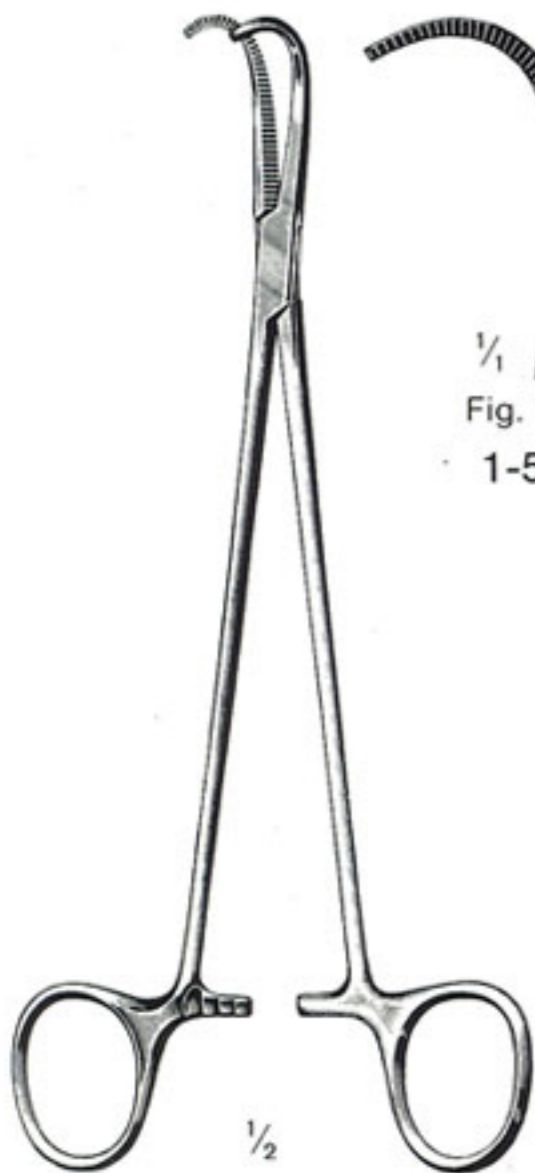
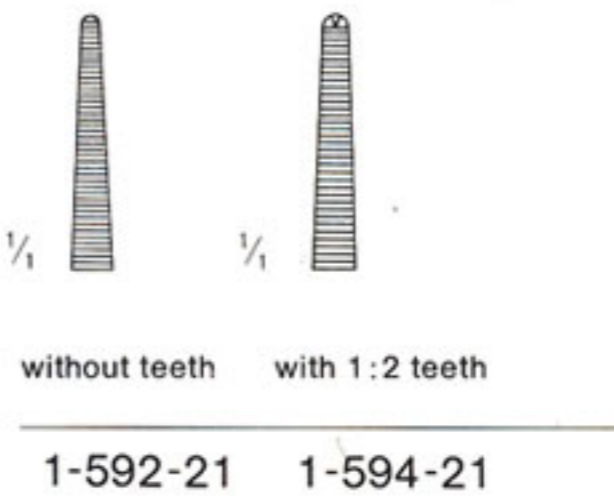

Negus
19 cm / 7 1/2"

Fig. 1
1-595-19

2
1-597-19

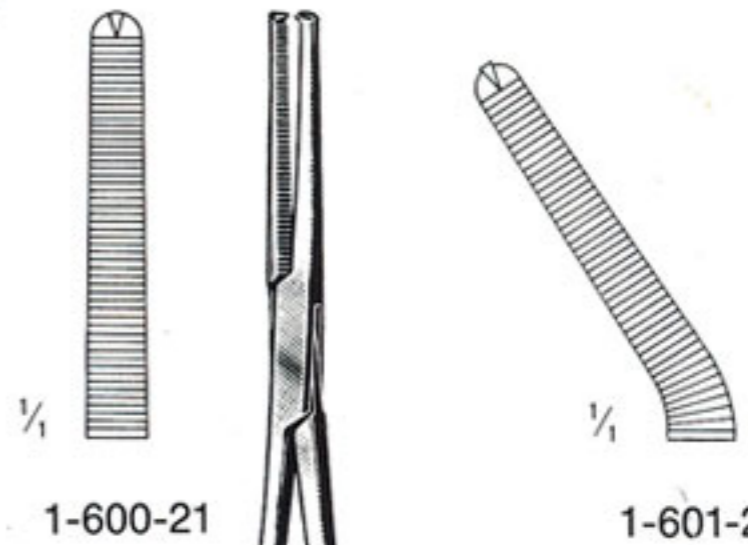

1-600-21

1-601-21

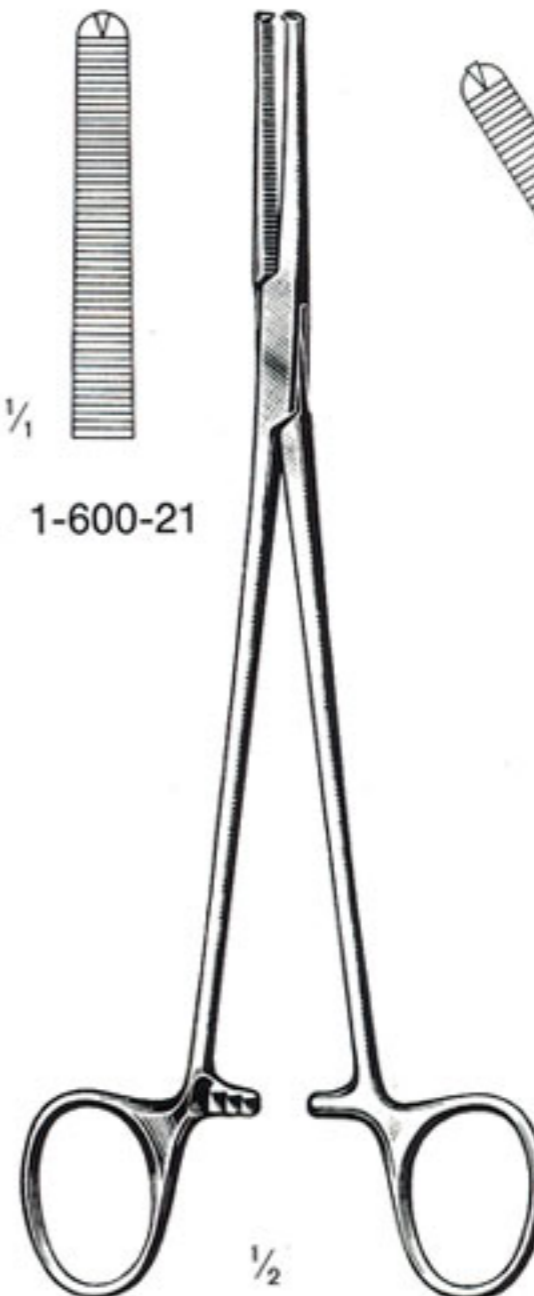

Phaneuf
21,5 cm / 8 1/2"
1:2

Tuchklemmen

Towel Forceps

Pinzas para compresas, Pinzas de campo



Schaedel
1-875-09
9 cm / 3 1/2"



Engl. Modell
1-877-09
9 cm / 3 1/2"



Jones
1-881-05 = 5 cm / 2"
1-881-09 = 9 cm / 3 1/2"



Jones-Martin
1-883-09
9 cm / 3 1/2"

with Clip for Tubing or Cable



Doyen
1-891-11
11 cm / 4 1/2"



Doyen
1-893-18
18 cm / 7"



1-909-11 = 11 cm / 4 1/2"
1-909-13 = 13 cm / 5"

delicate pattern



1-913-11
11 cm / 4 1/2"

with Clip for Tubing or Cable

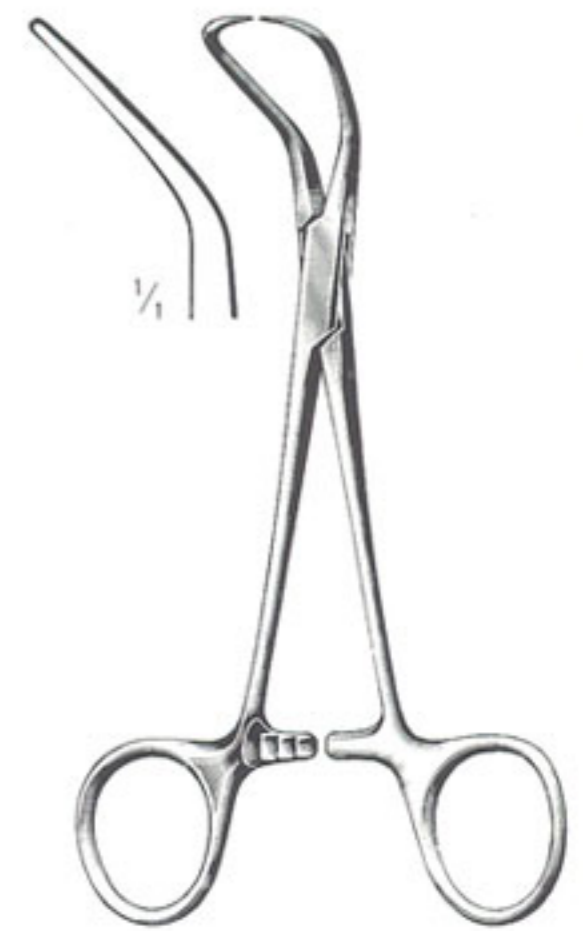

Backhaus
1-915-08 = 8 cm / 3 1/4"
1-915-11 = 11 cm / 4 1/2"
1-915-13 = 13 cm / 5"
1-915-15 = 15 cm / 6"

Tuchklemmen

Towel Forceps

Pinzas para compresas, Pinzas de campo



Roeder
1-917-13 = 13 cm / 5"
1-917-15 = 15 cm / 6"

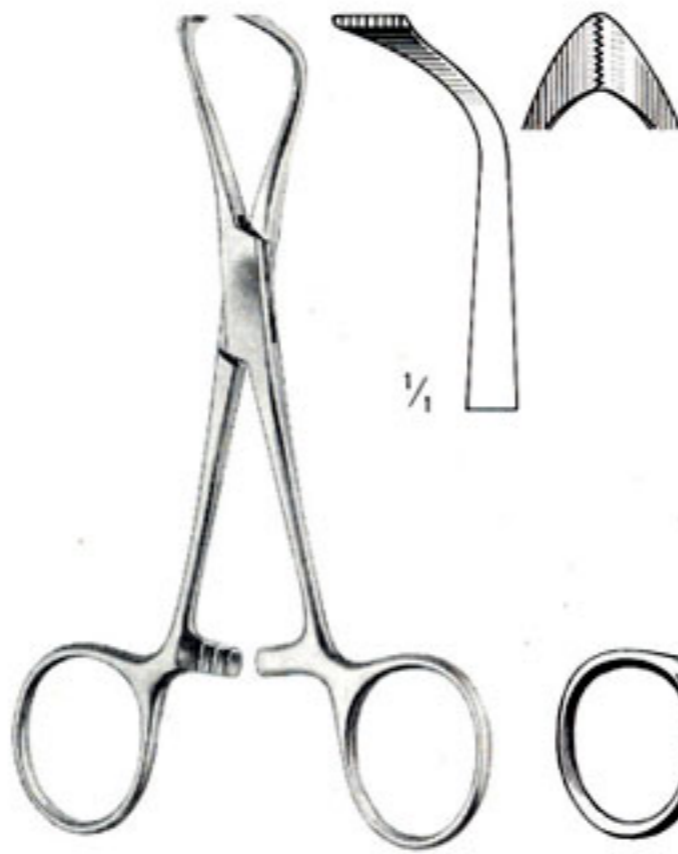

Lorna
1-919-10 = 10 cm / 4"
1-919-13 = 13 cm / 5"



Bernhard
1-921-16
16,5 cm / 6½"

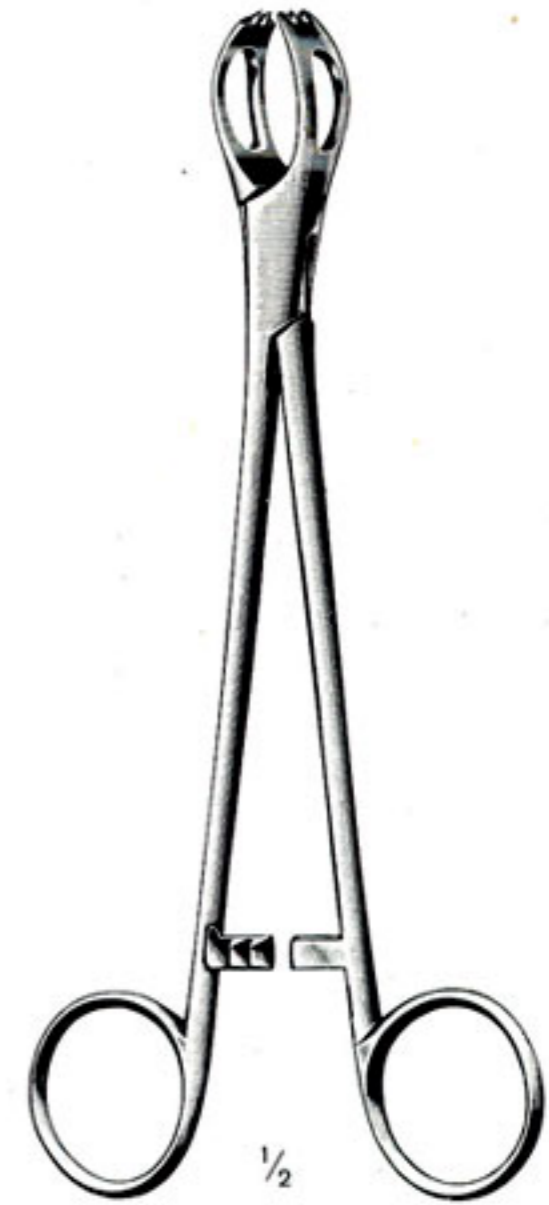

Lane
1-935-20
20 cm / 8"

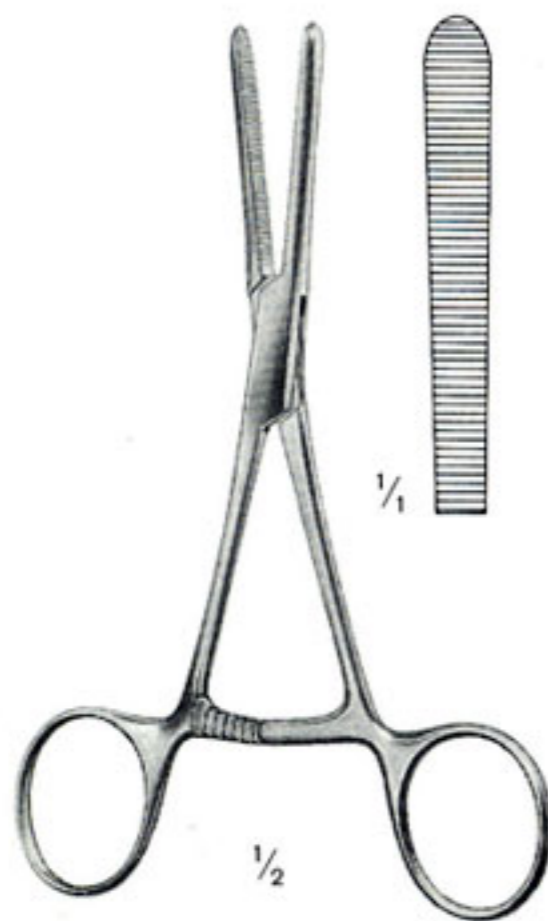

1-940-14
14,5 cm / 5¾"

With extra long ratchet

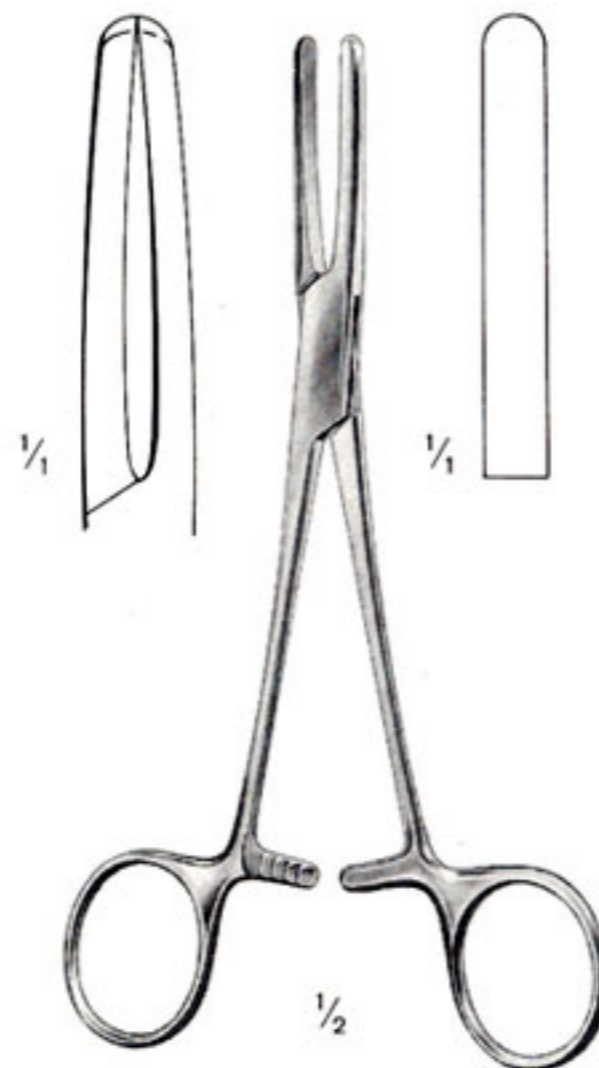

1-942-16
16,5 cm / 6½"

Korn-(Polypen-)Zangen, Tuferzangen Polypus and Dressing Forceps, Cotton Swab Pinzas para polipos y vendajes, Pinzas para tapones

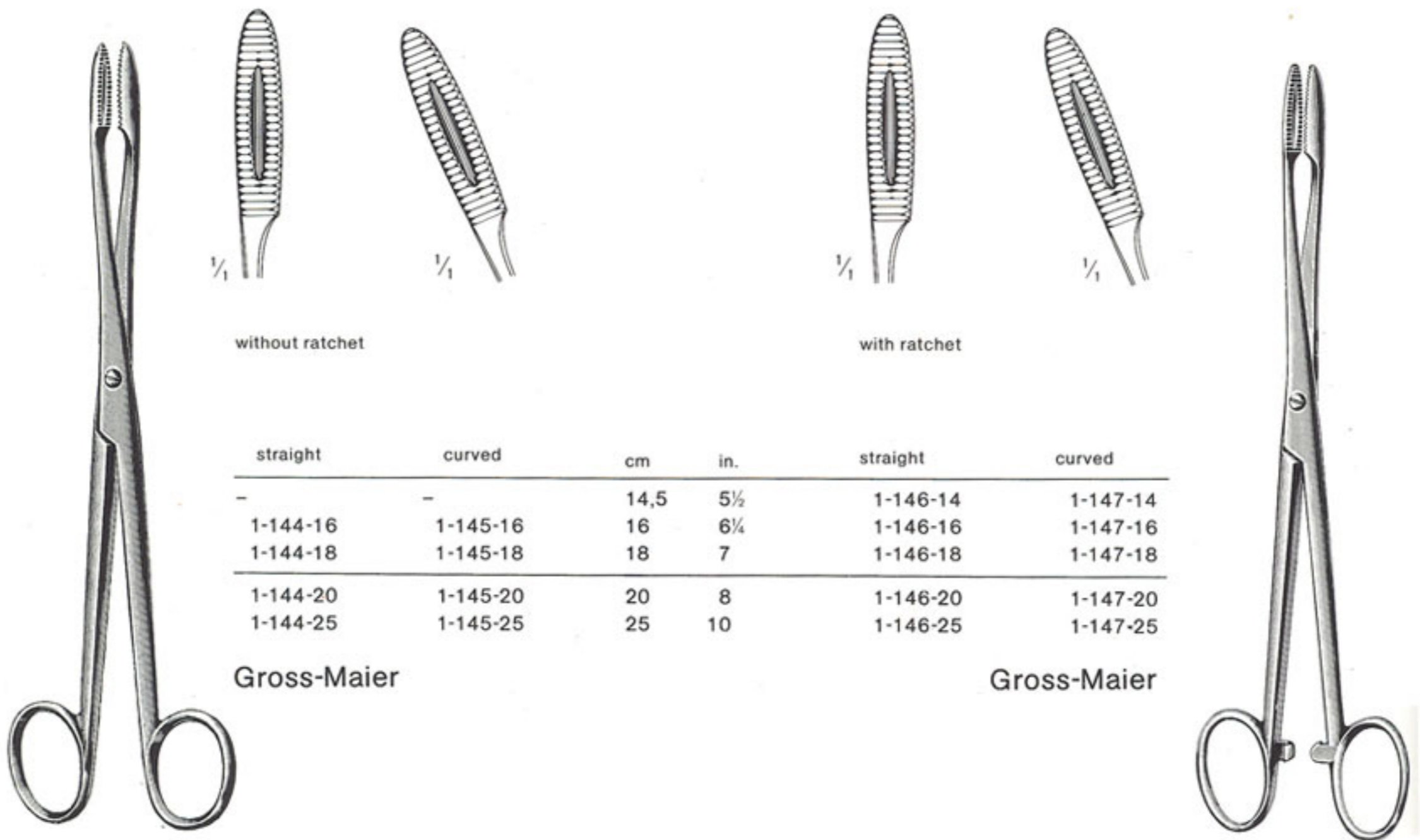

without ratchet

with ratchet

without ratchet				with ratchet	
straight	curved	cm	in.	straight	curved
-	-	14,5	5½	1-146-14	1-147-14
1-144-16	1-145-16	16	6¼	1-146-16	1-147-16
1-144-18	1-145-18	18	7	1-146-18	1-147-18
1-144-20	1-145-20	20	8	1-146-20	1-147-20
1-144-25	1-145-25	25	10	1-146-25	1-147-25

Gross-Maier

Gross-Maier

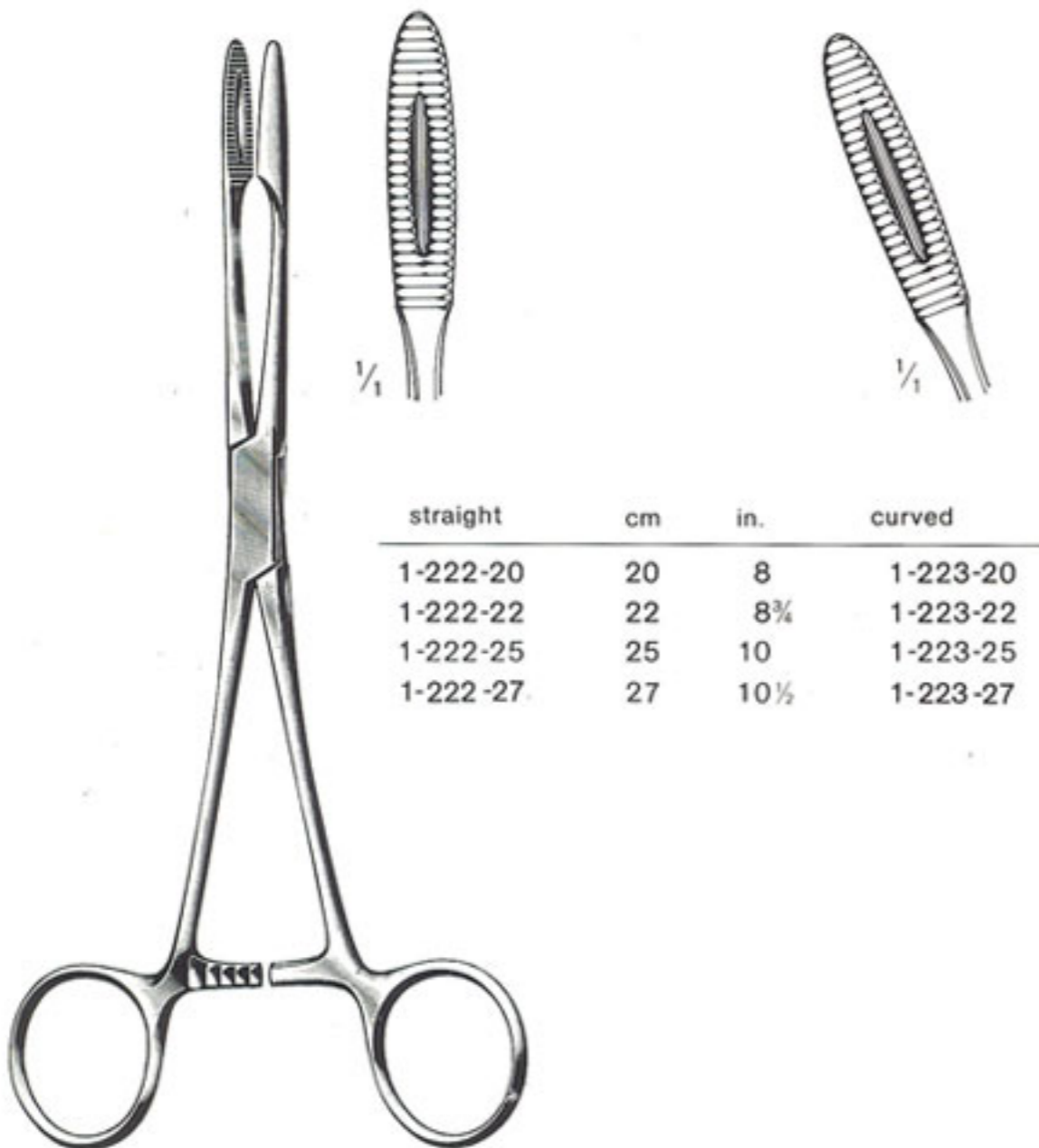

straight	cm	in.	curved
1-222-20	20	8	1-223-20
1-222-22	22	8¾	1-223-22
1-222-25	25	10	1-223-25
1-222-27	27	10½	1-223-27

Gross-Maier
20 cm / 8"

Korn-(Polypen-)Zangen, Tuferzangen
 Polypus and Dressing Forceps, Cotton Swab
 Pinzas para polipos y vendajes, Pinzas para tapones



Cheron
 1-290-25
 25 cm/10"

Bozemann
 1-313-26
 26 cm/10 1/4"

Bozemann-Douglas
 1-315-26
 26 cm/10 1/4"

Korn-(Polypen-)Zangen, Tuferzangen Polypus and Dressing Forceps, Cotton Swab Pinzas para polipos y vendajes, Pinzas para tapones

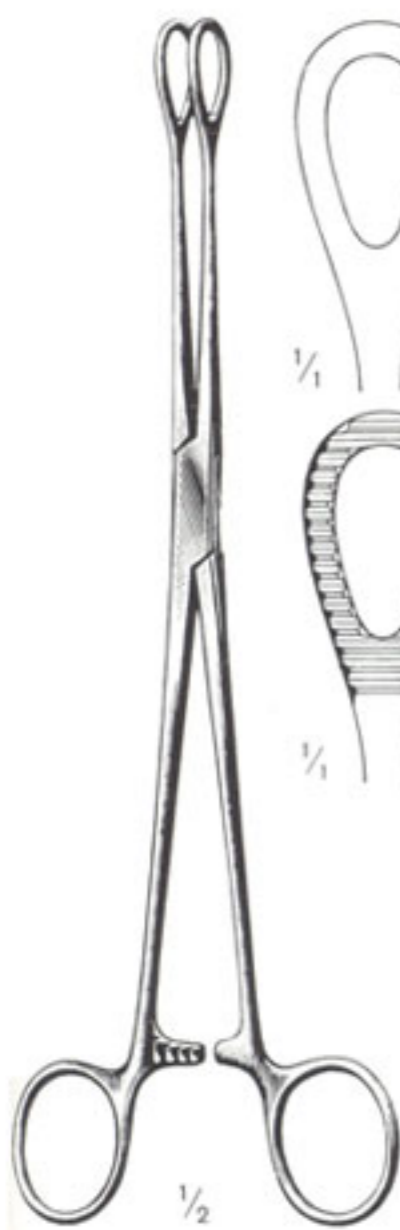

Foerster

Foerster
25 cm/10"



1/4

1/4



1/4



1/4



1/4

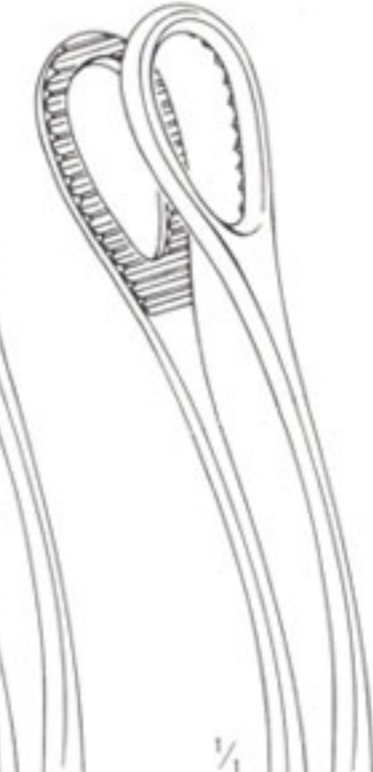

1/4

cm	in.			
18,0	7		1-352-18	1-355-18
20,0	8		1-352-20	1-355-20
25,0	10	1-350-25	1-352-25	1-355-25
				1-353-25

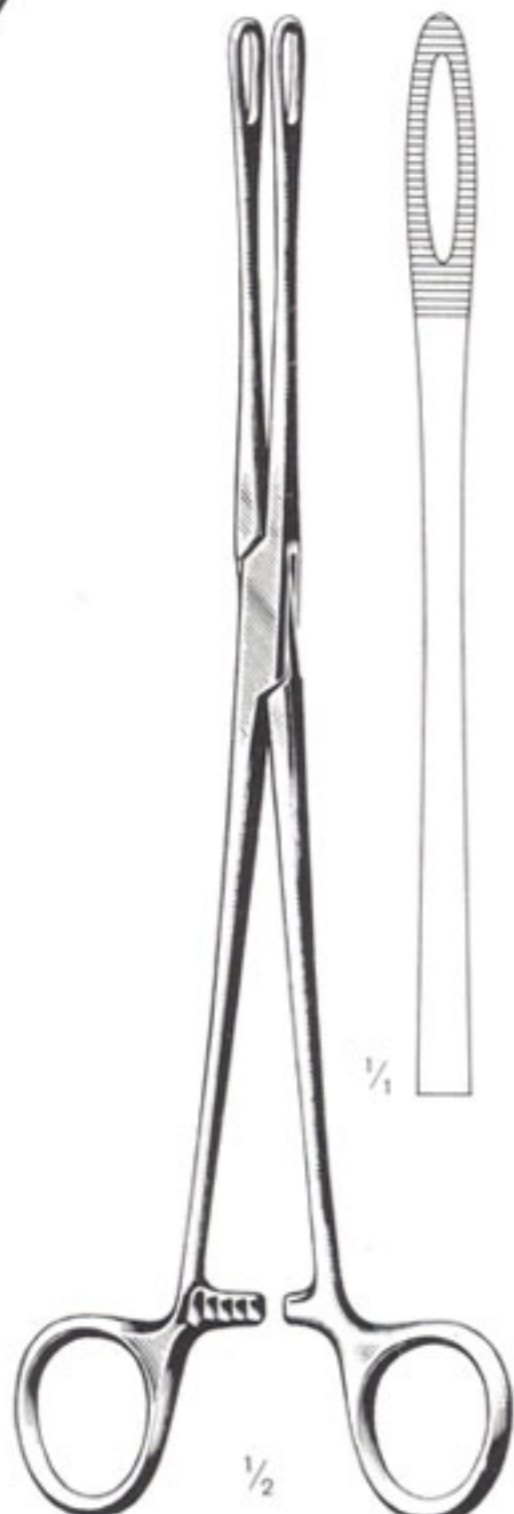

1/2



1/4

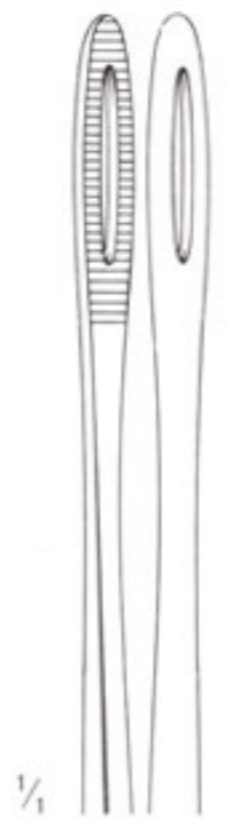

1/4

1-360-25

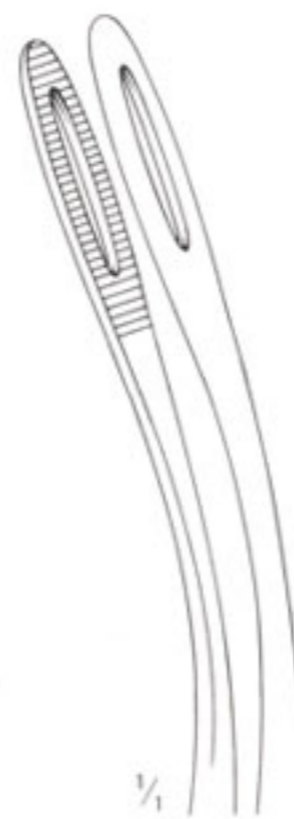

1/4

1-361-25

narrow



1/2



1/4

Rampley
1-370-25
25 cm/10"

Anatomische Pinzetten

Dressing Forceps

Pinzas de diseccion



cm	in.	Standard	Standard			Stille	Mod. Martin
10,5	4 1/4	1-100-10					
11,5	4 1/2	1-100-11	1-101-11	1-120-11			
13,0	5	1-100-13	1-101-13	1-120-13	1-124-13	1-126-13	1-134-13
14,5	5 1/2	1-100-14	1-101-14	1-120-14	1-124-14	1-126-14	1-134-14
15,0	6					1-130-15	
16,0	6 1/4	1-100-16	1-101-16	1-120-16	1-124-16		
18,0	7	1-100-18	1-101-18	1-120-18			
20,0	8	1-100-20	1-101-20	1-120-20			
25,0	10	1-100-25		1-120-25			
30,0	12	1-100-30		1-120-30			

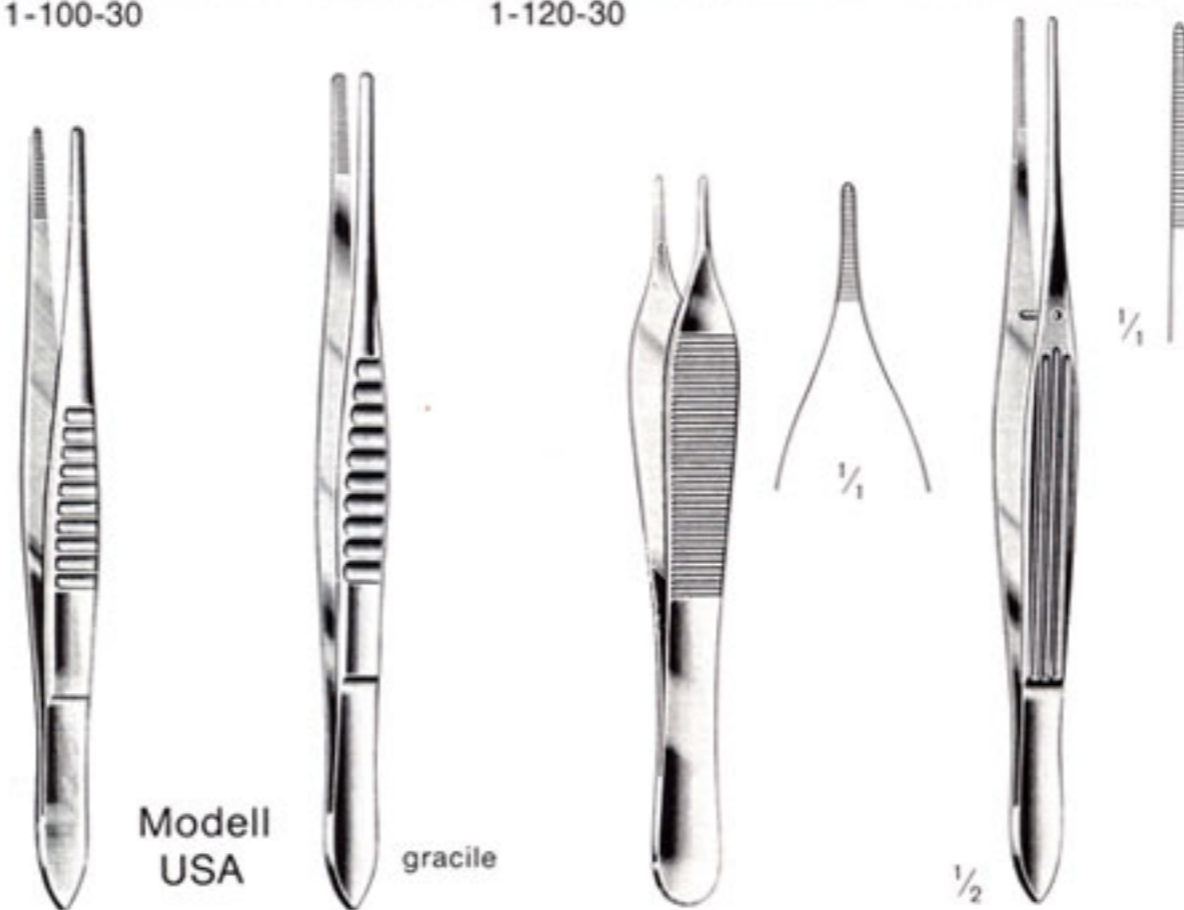

cm	in.	Standard		Adson	McIndoe
12,0	4 3/4	1-140-12	1-146-12	1-168-12	
13,0	5	1-140-13	1-146-13		
14,5	5 1/2	1-140-14	1-146-14		
15,0	6			1-168-15	1-170-15
15,5	6	1-140-15	1-146-15		
18,0	7	1-140-18			
21,0	8 1/4	1-140-21			
25,0	10	1-140-25			
31,0	12 1/4	1-140-31			

Anatomische Pinzetten

Dressing Forceps

Pinzas de diseccion



cm	in.	Semken	Taylor	Taylor	Taylor	Taylor
12,5	5	1-172-12	1-173-12			
15,5	6	1-172-15	1-173-15			
17,5	7		1-174-17	1-175-17	1-180-17	1-183-17

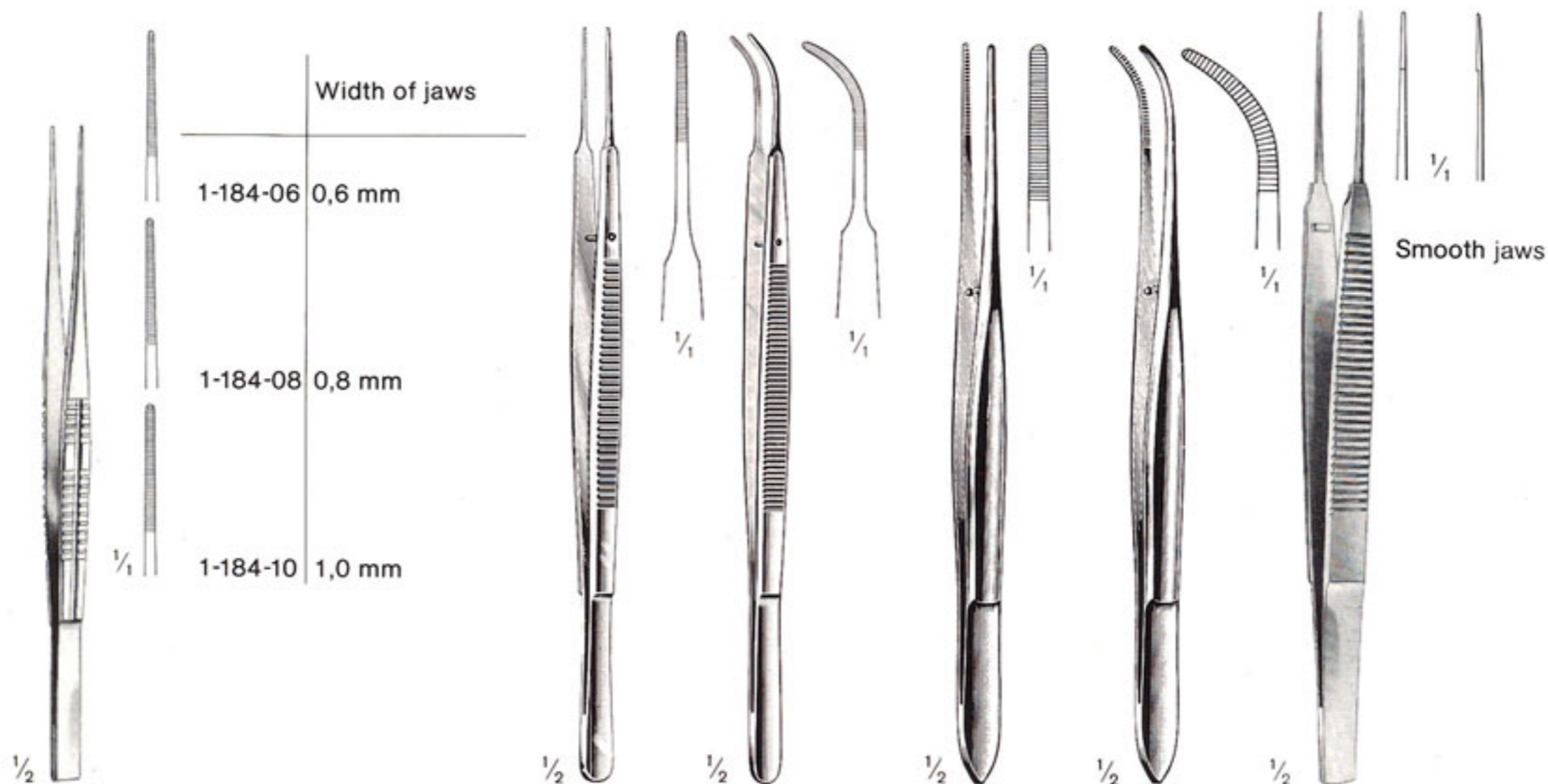

cm	in.	Gerald	Gerald	Cushing	Cushing	
14,0	5					1-190-14
17,5	7			1-188-17	1-189-17	
18,0	7	1-186-18	1-187-18			1-190-18

Anatomische Pinzetten

Dressing Forceps

Pinzas de diseccion



cm	in.	Potts-Smith		Brophy		Duehrssen	Wangensteen
18,0	7	1-192-18	1-193-18				1-220-23
20,0	8			1-196-20	1-197-20	1-210-20	23 cm/9"
21,0	8¼	1-192-21	1-193-21				
25,0	10	1-192-25	1-193-25				

Chirurgische Pinzetten

Tissue Forceps

Pinzas de diseccion con dientes



cm	in.	1:2	2:3	3:4	4:5	1:2	1:2	1:2
10,5	4 1/4	1-301-10				schmal	narrow	estrechas
11,5	4 1/2	1-301-11	1-302-11					
13,0	5	1-301-13	1-302-13	1-303-13	1-304-13	1-321-13	1-326-13	1-329-13
14,5	5 1/2	1-301-14	1-302-14	1-303-14	1-304-14	1-321-14	1-326-14	1-329-14
16,0	6 1/4	1-301-16	1-302-16	1-303-16	1-304-16	1-321-16		
18,0	7	1-301-18	1-302-18					
20,0	8	1-301-20	1-302-20			1-321-20		
25,0	10	1-301-25	1-302-25					
30,0	12	1-301-30	1-302-30					



cm	in.	Stille 1:2	Stille 2:3	Mod. Martin 1:2	Mod. USA 1:2	Mod. USA 2:3	Mod. USA 3:4	Mod. USA 4:5
12,0	4 3/4				1-341-12			
13,0	5			1-334-13	1-341-13	1-342-13	1-343-13	1-344-13
14,5	5 1/2			1-334-14	1-341-14	1-342-14	1-343-14	1-344-14
15,0	6	1-331-15	1-332-15					
15,5	6				1-341-15	1-342-15	1-343-15	1-344-15
18,5	7 1/4				1-341-18			
21,0	8 1/4				1-341-21			
25,0	10				1-341-25			
31,0	12 1/4				1-341-31			

Chirurgische Pinzetten

Tissue Forceps

Pinzas de diseccion con dientes

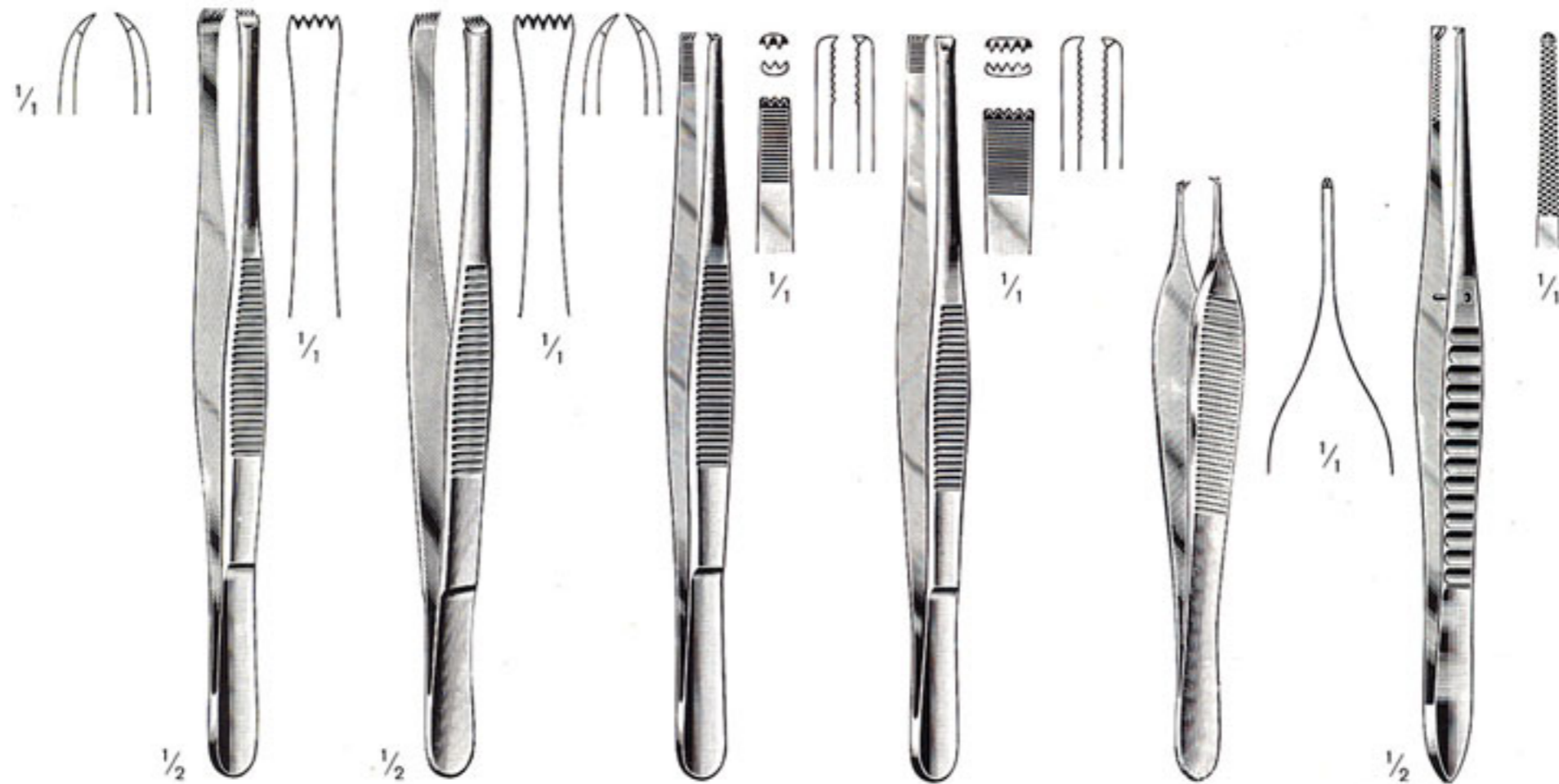

cm	in.	Stone 4:5	Lerche 5:6	Adlerkreutz 2:3	Adson 4:5	Adson 1:2	Gillies 1:2
12,0	4 3/4"					1-368-12	
15,0	6	1-364-15	1-365-15	1-366-15	1-367-15	1-368-15	1-370-15
20,0	8			1-366-20	1-367-20		



	Width of jaws
1-384-06	0,6 mm
1-384-08	0,8 mm
1-384-10	1,0 mm

cm	in.	Semken 1:2	Semken 1:2	Taylor 1:2	Taylor 1:2	Taylor 1:2	Taylor 1:2
12,5	5	1-372-12	1-373-12				
15,0	6	1-372-15	1-373-15				
17,5	7			1-374-17	1-375-17	1-380-17	1-383-17

Chirurgische Pinzetten

Tissue Forceps

Pinzas de diseccion con dientes



cm	in.	Gerald 1:2	Gerald 1:2	Cushing 1:2	Cushing 1:2	Potts-Smith	Brophy	Brophy
17,0	6 3/4	1-386-17	1-387-17	1-388-17	1-389-17			
18,0	7					1-392-18	1-393-18	
20,0	8						1-396-20	1-397-20
21,0	8 1/4					1-392-21	1-393-21	
25,0	10					1-392-25	1-393-25	



Adson-Brown
1-400-12
12 cm / 4 3/4"
7 : 7 Zähne · Teeth
Dientes

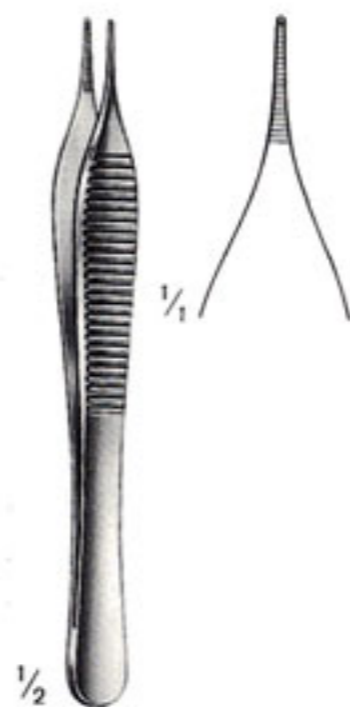

Micro-Adson
1-404-12
12 cm / 4 3/4"

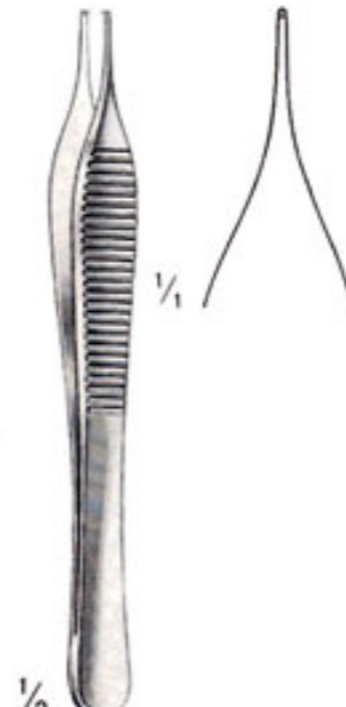

Micro-Adson
1-406-12
12 cm / 4 3/4"
1 : 2 Zähne · Teeth
Dientes



1-408-11
11 cm / 4 1/2"

Teeth extremely delicate

Splitterzangen Splinter Forceps Pinzas para espinas

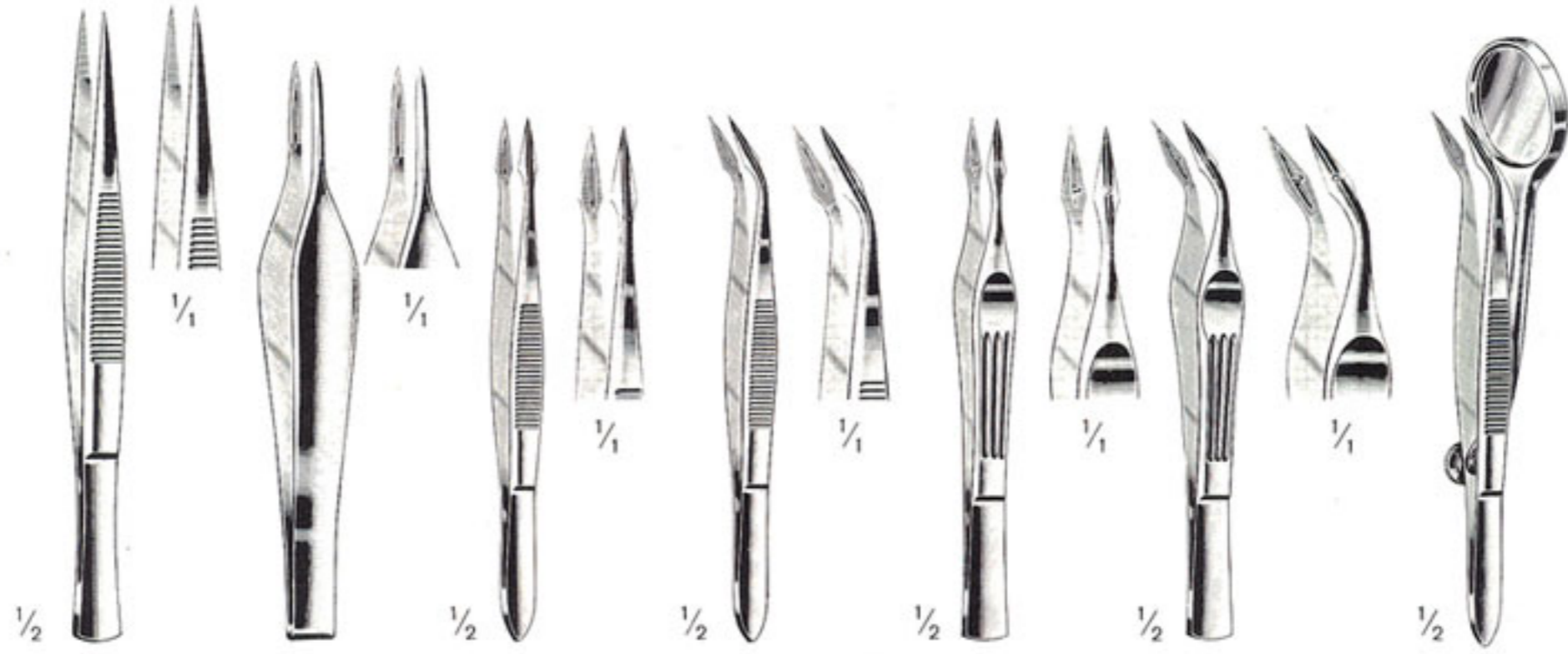

Feilchenfeld Hunter Hunter Walter-Carmalt

cm	in.				
7,5	3		1-630-07		
9,0	3 1/2		1-630-09		
10,5	4 1/4			1-640-10	1-641-10
11,5	4 1/2		1-630-11		1-650-10
12,0	4 3/4				1-651-10
12,5	5	1-622-12			1-654-12

Lightweight Forceps



1-657-10 1-659-10
10 cm / 4" 10 cm / 4"

Shaaf
1-661-09
9 cm / 3 1/2"

Littauer
1-664-08
8,5 cm / 3 1/2"

1-666-09
9 cm / 3 1/2"

Splitterzangen Splinter Forceps Pinzas para espinas

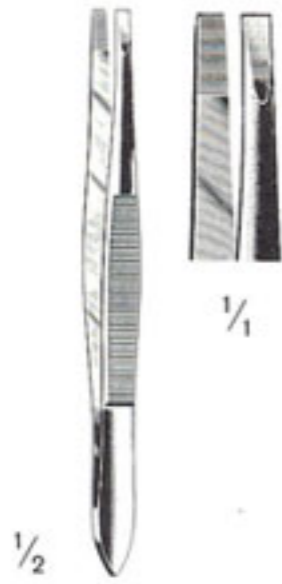

Douglas
1-674-09
9 cm / 3½"

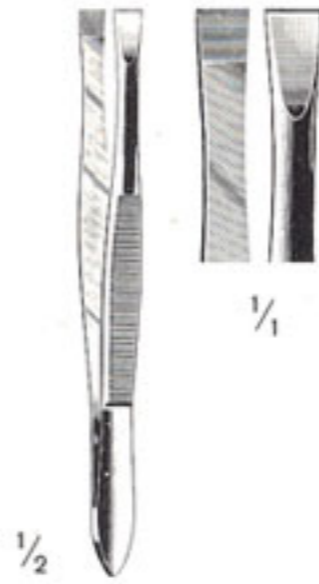

Douglas
1-676-09
9 cm / 3½"

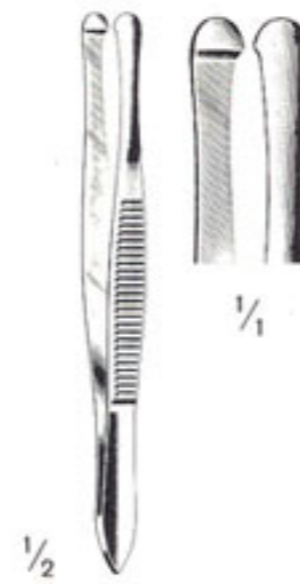

Beer
1-680-09
9 cm / 3½"



Beaupré
1-687-12
12 cm / 4¾"

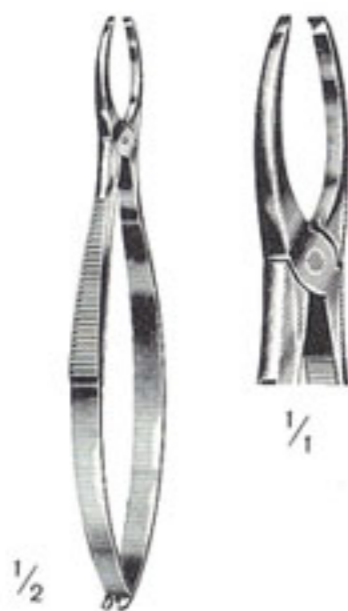

Gradle
1-691-09
9,5 cm / 3¾"



Henry
1-694-12
12 cm / 4¾"



Barraquer
1-695-10
10,5 cm / 4¼"

Chirurgische Scheren Operating Scissors Tijeras para cirugia

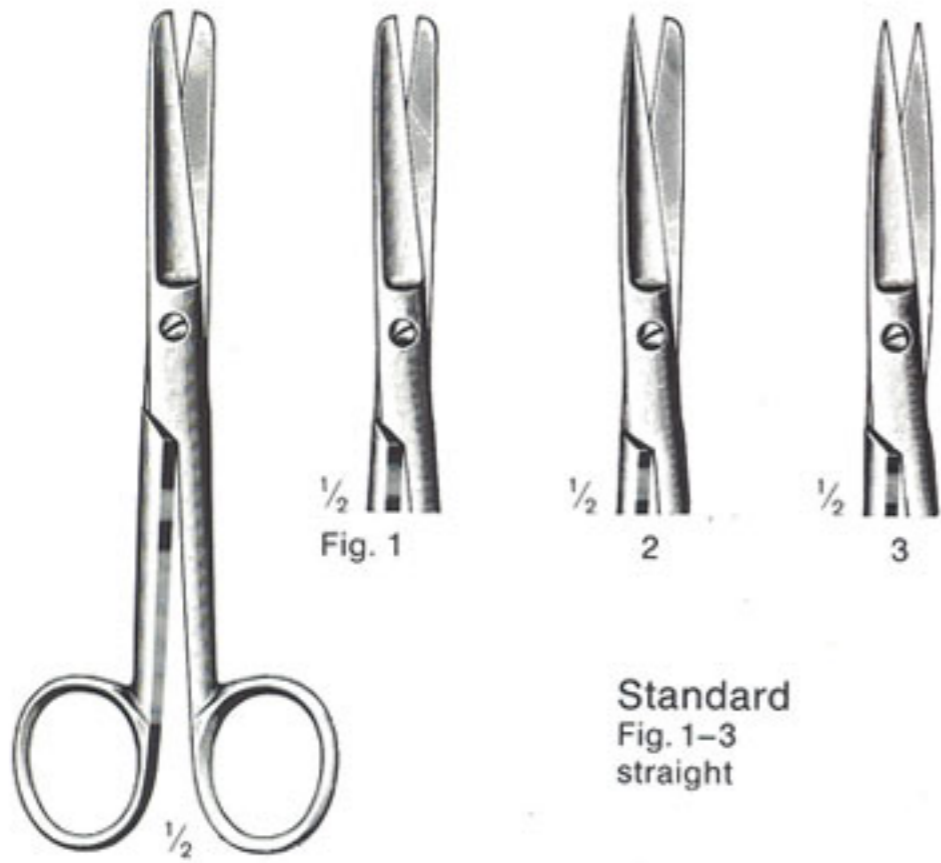

Standard
Fig. 1-3
straight

cm	in.	Fig. 1	2	3
10,5	4¼	1-100-10	1-102-10	1-104-10
11,5	4½	1-100-11	1-102-11	1-104-11
13,0	5	1-100-13	1-102-13	1-104-13
14,5	5½	1-100-14	1-102-14	1-104-14
15,5	6	1-100-15	1-102-15	1-104-15
16,5	6½	1-100-16	1-102-16	1-104-16
18,5	7¼	1-100-18	1-102-18	
20,0	8	1-100-20	1-102-20	

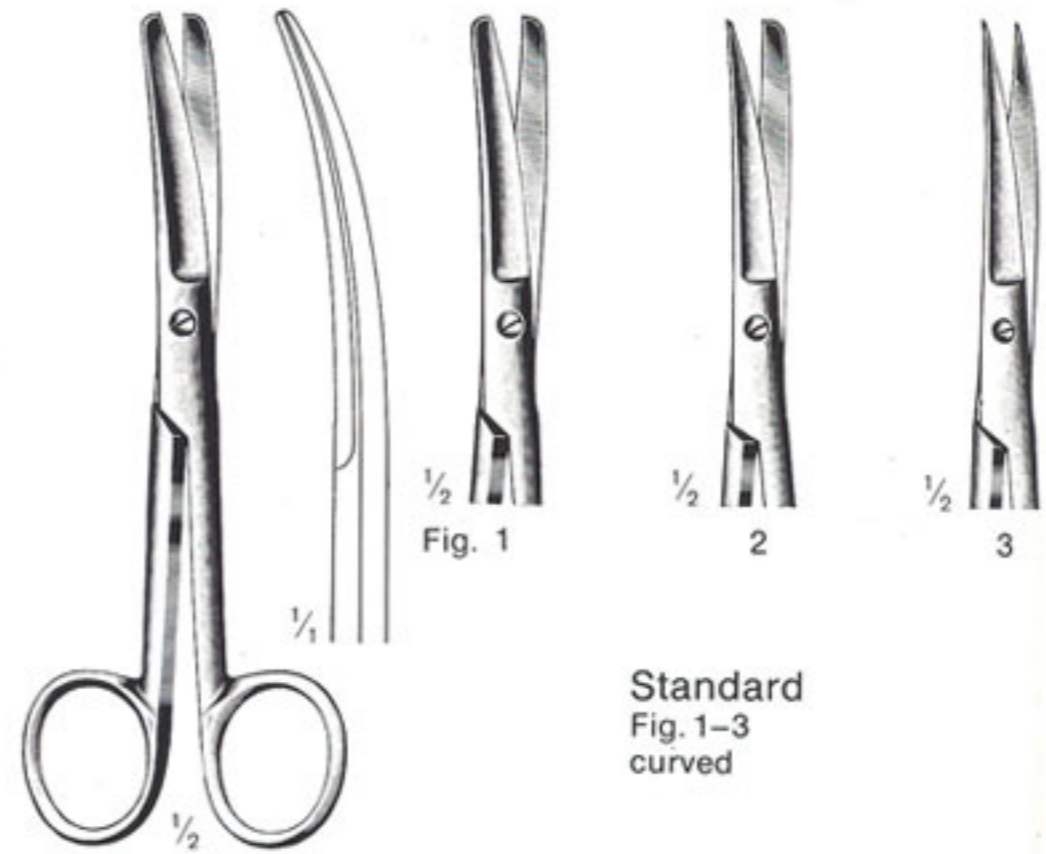

Standard
Fig. 1-3
curved

cm	in.	Fig. 1	2	3
11,5	4½	1-105-11	1-107-11	1-109-11
13,0	5	1-105-13	1-107-13	1-109-13
14,5	5½	1-105-14	1-107-14	1-109-14
15,5	6	1-105-15	1-107-15	1-109-15
16,5	6½	1-105-16	1-107-16	1-109-16
18,5	7¼	1-105-18	1-107-18	
20,0	8	1-105-20	1-107-20	

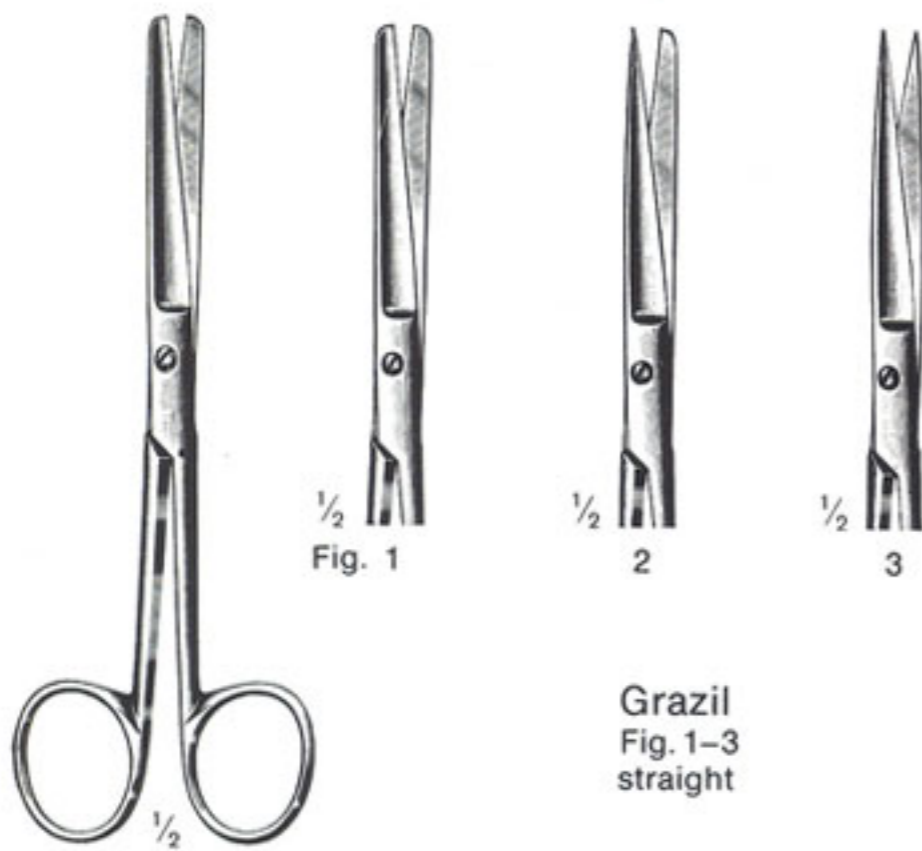

Graziil
Fig. 1-3
straight

cm	in.	Fig. 1	2	3
13,0	5		1-122-13	
14,5	5½	11-120-14	1-122-14	1-124-14

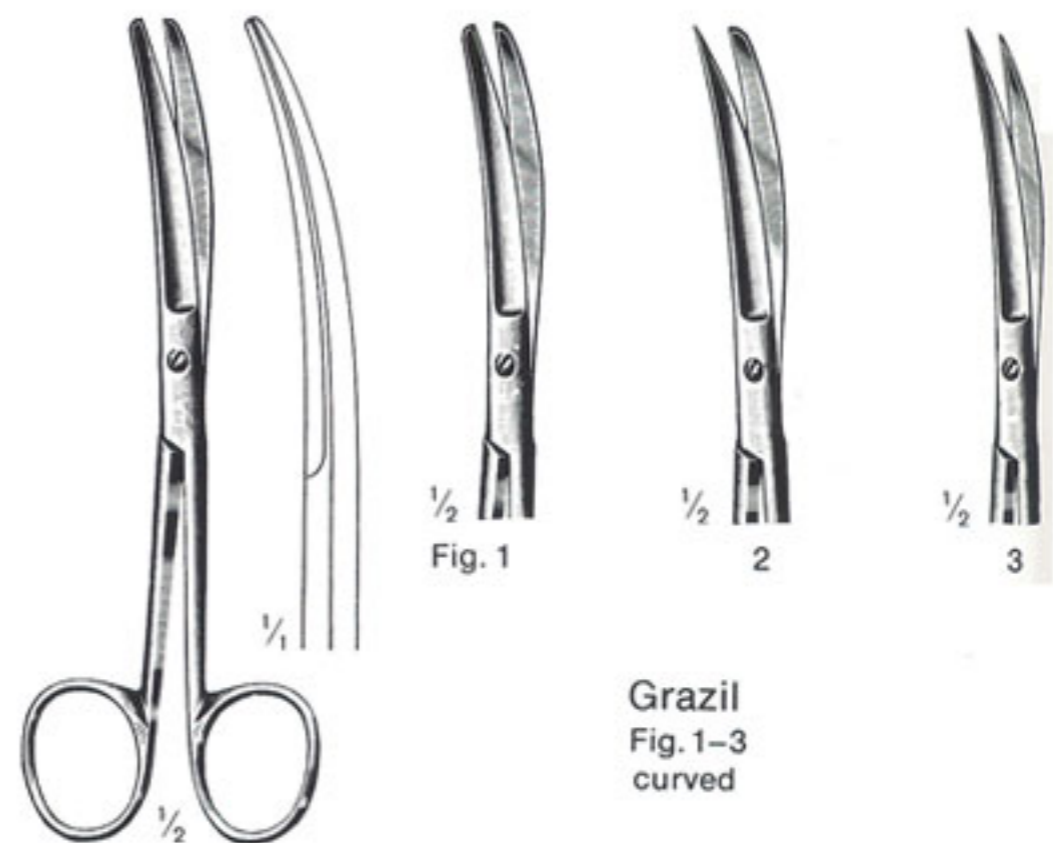

Graziil
Fig. 1-3
curved

cm	in.	Fig. 1	2	3
13,0	5		1-127-13	
14,5	5½	1-125-14	1-127-14	1-129-14

Chirurgische Scheren Operating Scissors Tijeras para cirugía



1-136-13 = 13 cm/5"
1-136-14 = 14,5 cm/5 1/2"



1-141-14

Deaver
1-140-14
14 cm/5 1/2"

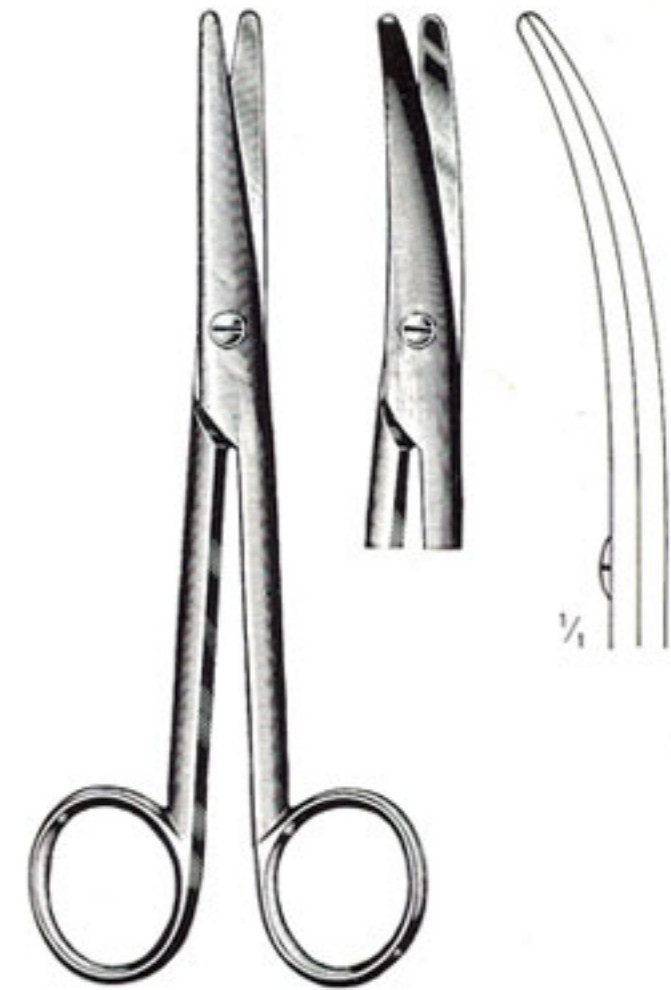
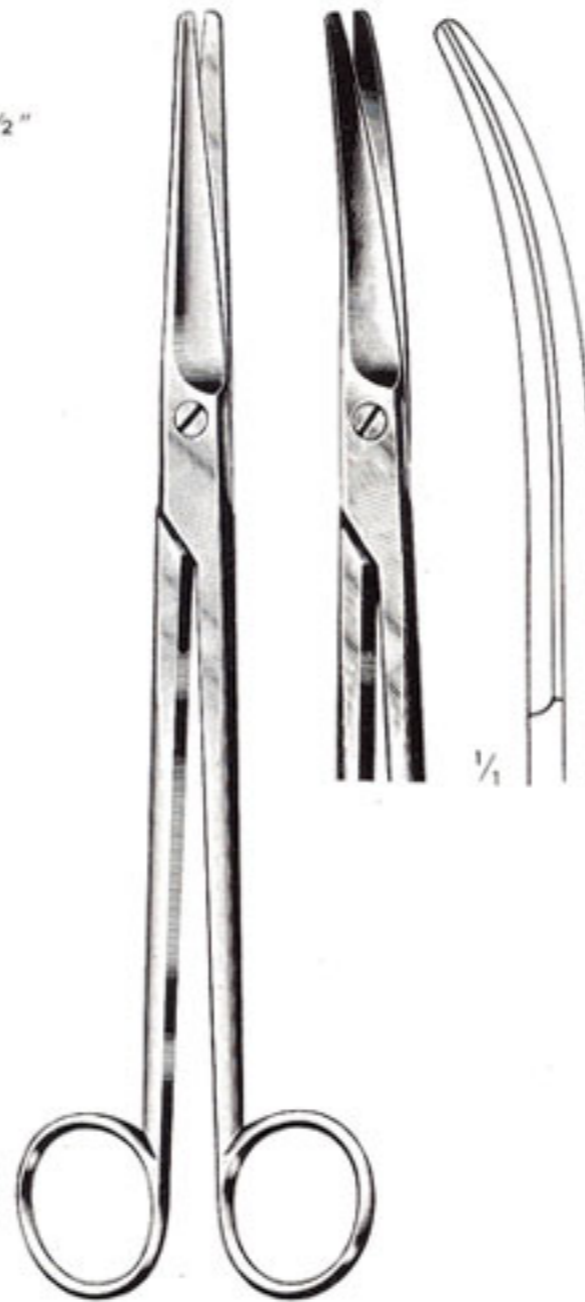
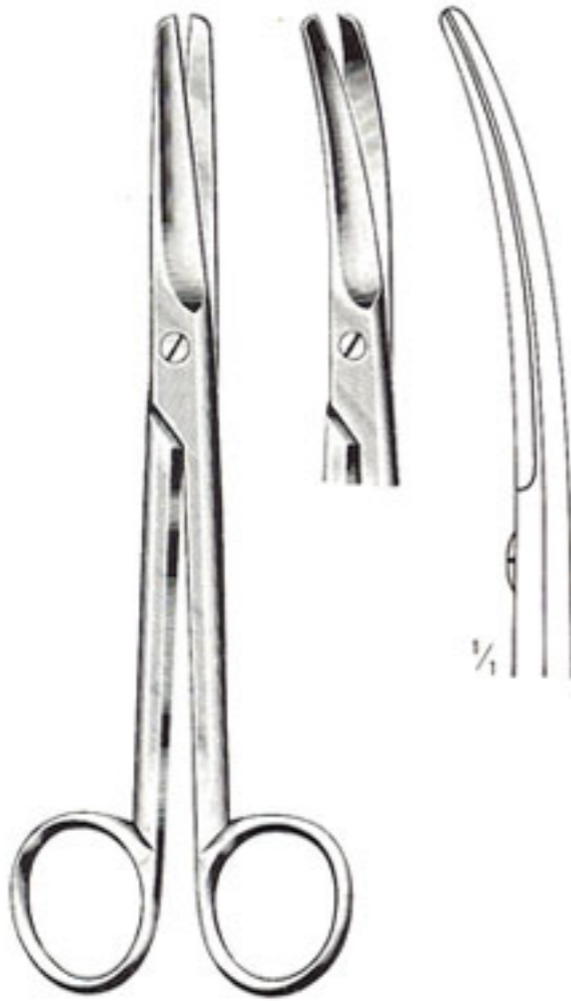

Mayo

Mayo-Harrington

Mayo-Stille

cm	in.	Mayo		Mayo-Harrington		Mayo-Stille	
		straight	curved	straight	curved	straight	curved
14,5	5 1/2	1-170-14	1-171-14				
15,0	6	1-170-15	1-171-15			1-180-15	1-181-15
17,0	6 3/4	1-170-17	1-171-17			1-180-17	1-181-17
22,5	9			1-174-22	1-175-22		
23,0	9	1-170-23	1-171-23				
30,0	12				1-175-30		

1-170-23
1-171-23
1-174-22
1-175-22

Uterine Scissors

Chirurgische Scheren Operating Scissors Tijeras para cirugía

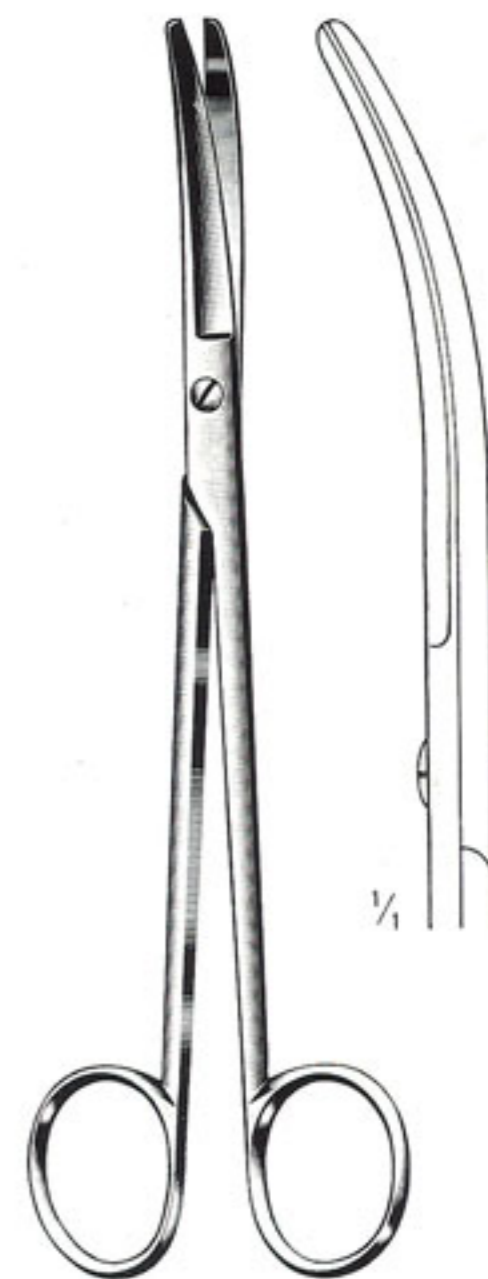
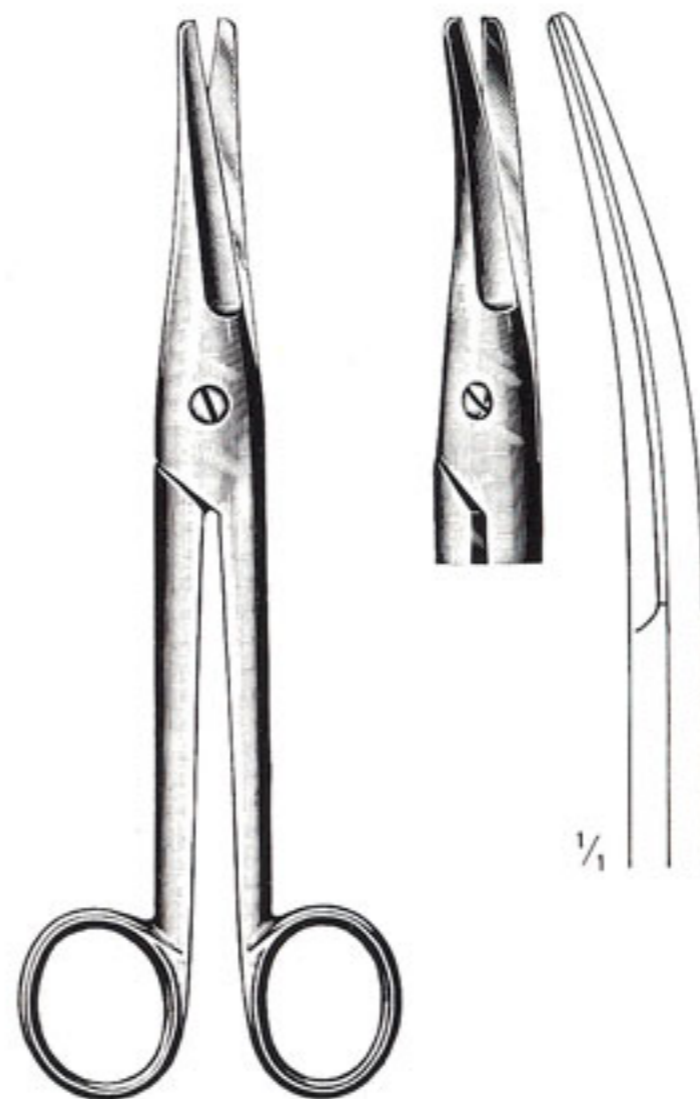
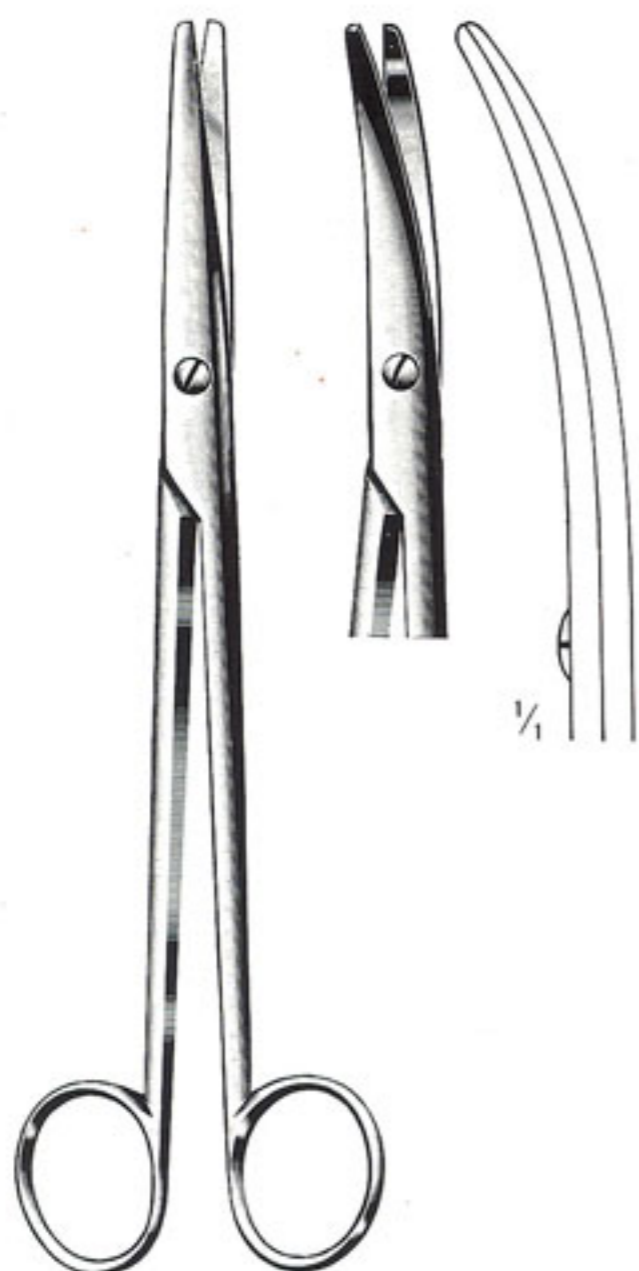

cm	in.	Mayo-Stille		Mayo-Noble		Wertheim
		straight	curved	straight	curved	curved
14,5	5 1/2					1-195-14
16,5	6 1/2	1-184-16	1-185-16			
17,0	6 3/4			1-190-17	1-191-17	
19,5	7 3/4	1-184-19	1-185-19			1-195-19
21,0	8 1/4	1-184-21	1-185-21			
22,5	9					1-195-22

Gynakologische Scheren
 Gynecological Scissors
 Tijeras para ginecologia



Sims

Sims

Sims-Martin

Siebold

straight

curved

straight

curved

S-curved

Fig. 1

Fig. 1

cm	in.
20,0	8
22,0	8½
23,0	9
24,0	9½

1-200-20

1-203-20

1-206-22

1-207-22

1-200-23

1-203-23

1-211-24

Gynakologische Scheren Gynecological Scissors Tijeras para ginecologia

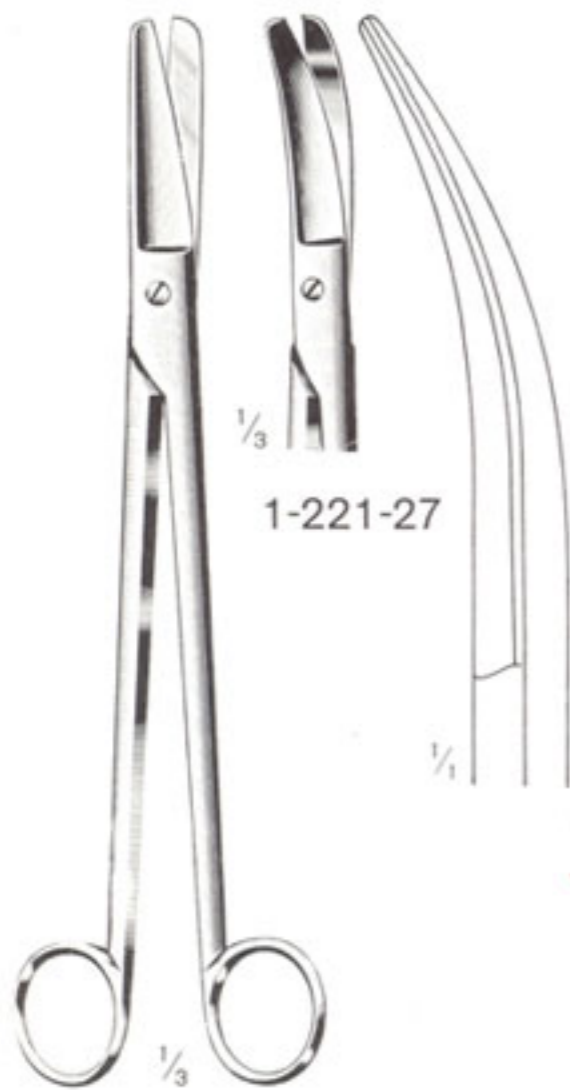

Dubois
1-220-27
27 cm / 10 1/2"

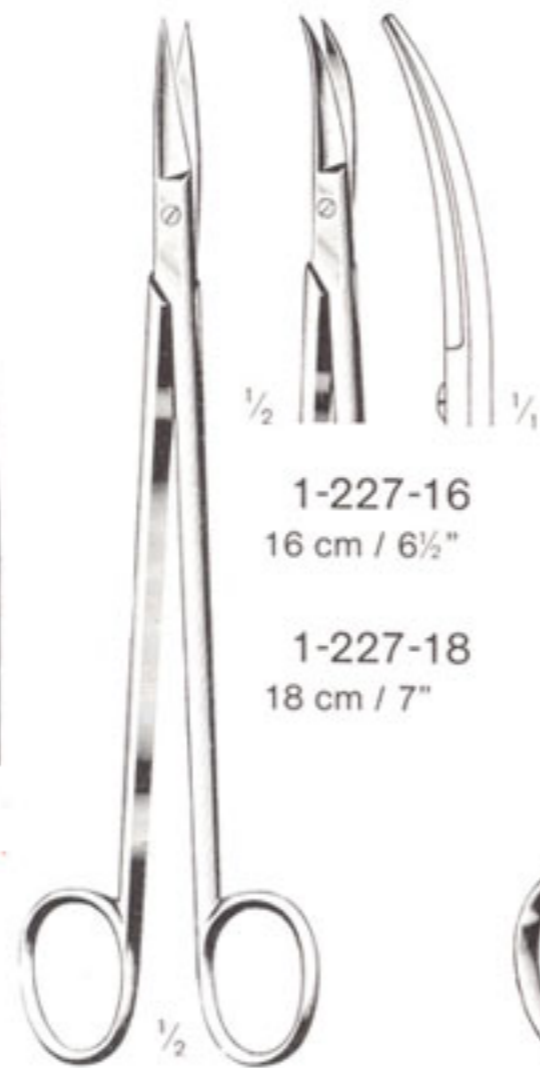

Kelly
1-226-16 = 16 cm / 6 1/2"
1-226-18 = 18 cm / 7"

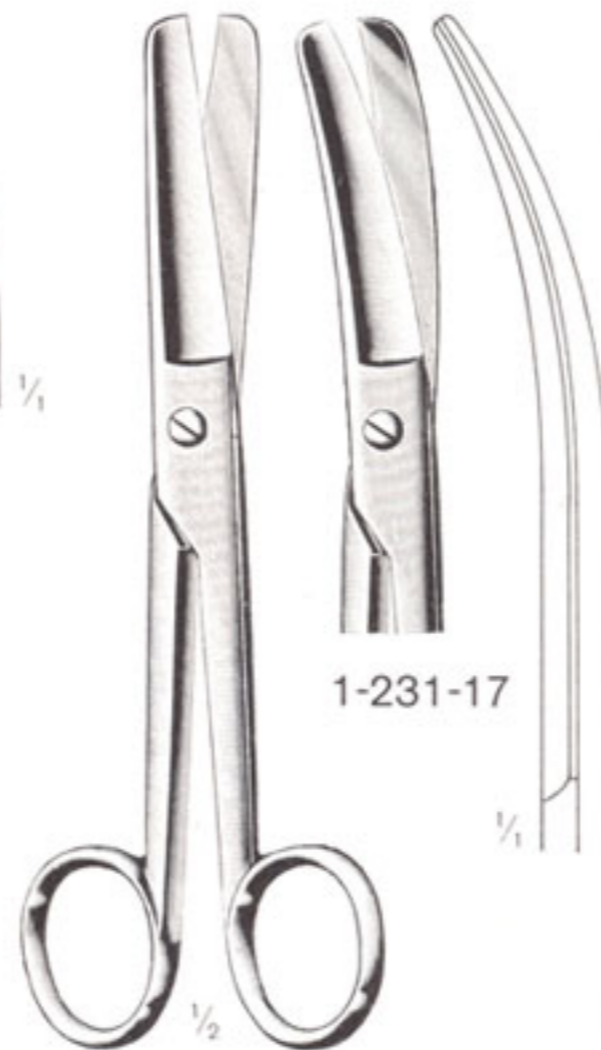

Doyen
1-230-17
17,5 cm / 7"



1-248-11
11,5 cm / 4 1/2"



Metzenbaum
14,5 cm / 5 1/2"



Metzenbaum
14,5 cm / 5 1/2"

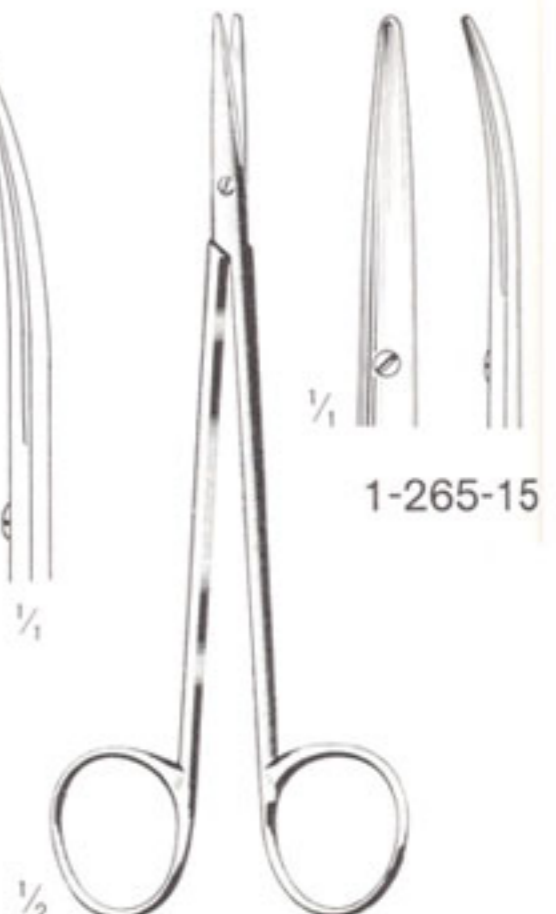

Metzenbaum
1-264-15 = 15 cm / 6"

- | | | |
|------------|----------|------------------------|
| 1-220-27 - | 1-221-27 | - Cephalotomy Scissors |
| 1-226-18 - | 1-227-18 | - Fistula Scissors |
| 1-230-17 - | 1-231-17 | - Abdominal Scissors |

Praparierscheren Dissecting Scissors Tijeras para preparaciones

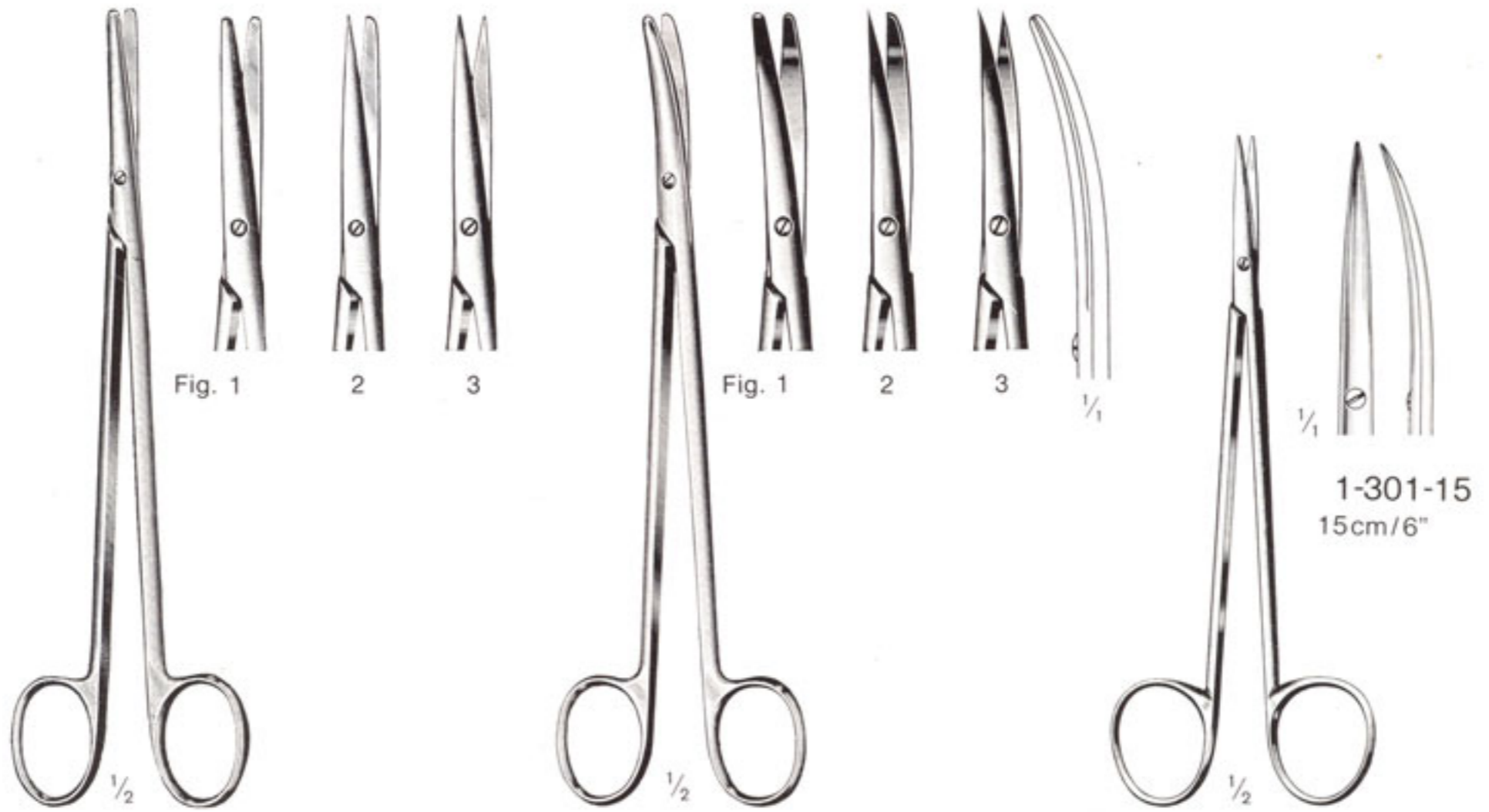

cm	in.	Metzenbaum-Nelson			Metzenbaum-Nelson		
		Fig. 1	2	3	Fig. 1	2	3
18,0	7	1-280-18	1-282-18	1-284-18	1-285-18	1-287-18	1-289-18
20,0	8	1-280-20	1-282-20	1-284-20	1-285-20	1-287-20	1-289-20
23,0	9	1-280-23	1-282-23	1-284-23	1-285-23	1-287-23	1-289-23
25,0	10	1-280-25	1-282-25	1-284-25	1-285-25	1-287-25	1-289-25
28,0	11	1-280-28	1-282-28	1-284-28	1-285-28	1-287-28	1-289-28
30,0	12	1-280-30	1-282-30	1-284-30	1-285-30	1-287-30	1-289-30

Nerv-Präparierschere
1-300-15
15cm/6"
Nerve dissecting scissors

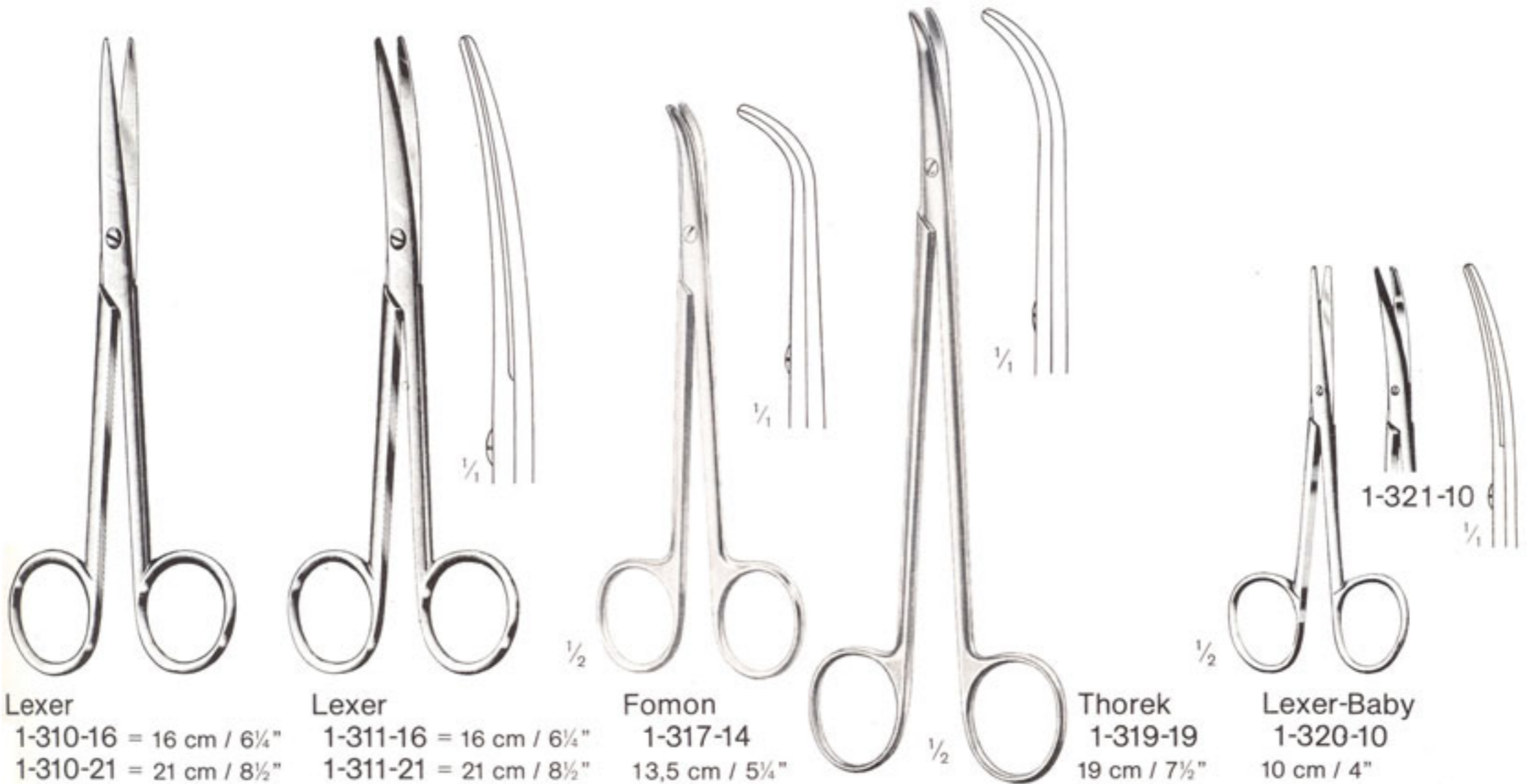

Lexer
1-310-16 = 16 cm / 6 1/4"
1-310-21 = 21 cm / 8 1/2"

Lexer
1-311-16 = 16 cm / 6 1/4"
1-311-21 = 21 cm / 8 1/2"

Fomon
1-317-14
13,5 cm / 5 1/4"

Thorek
1-319-19
19 cm / 7 1/2"

Lexer-Baby
1-320-10
10 cm / 4"

Thoraxscheren, Gefabscheren Scissors, Thorax and Vascular Tijeras toracicas y vasculares

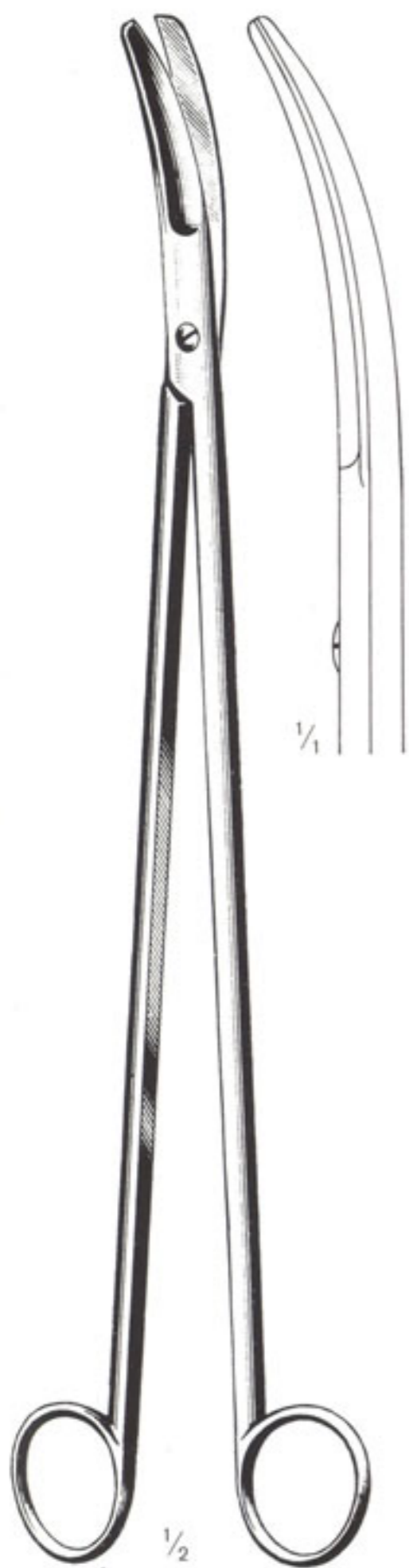

Crafoord
1-371-30
30 cm/12"

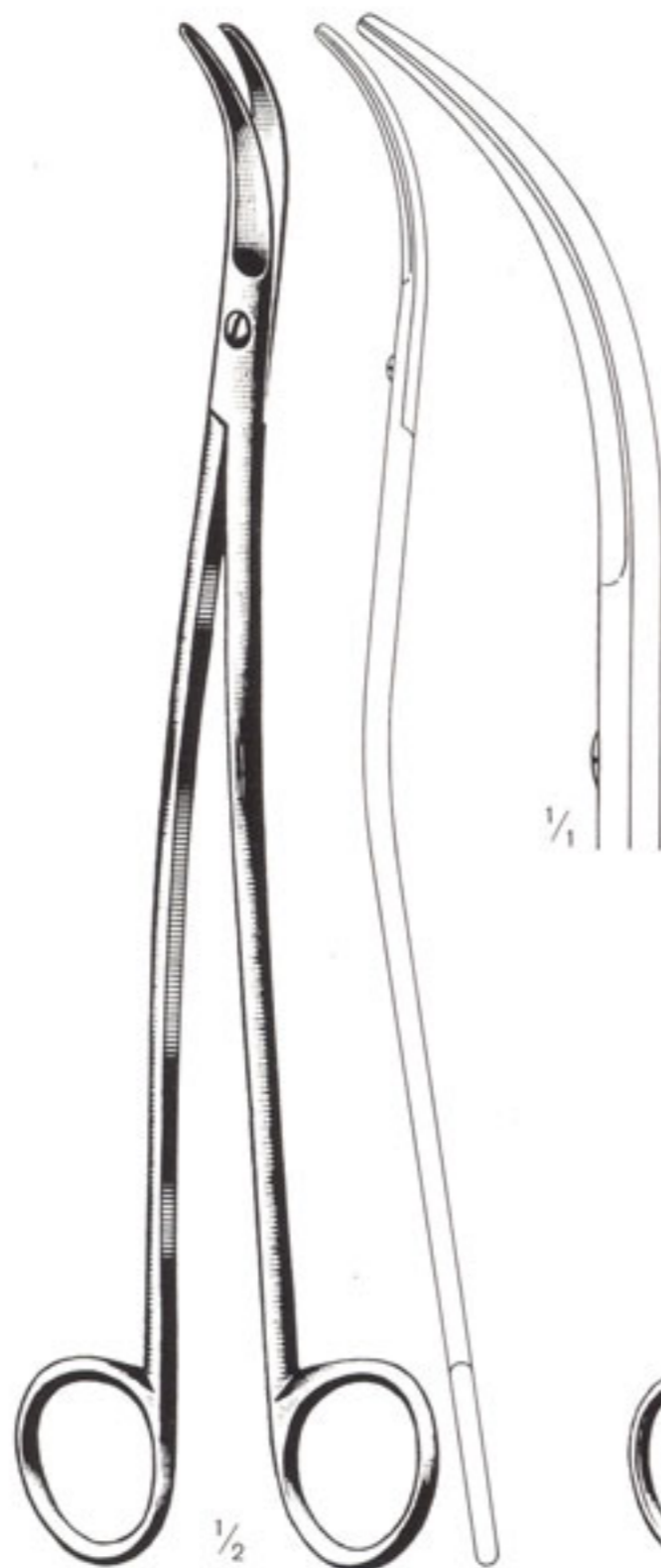

Satinsky
1-375-24
24,5 cm/10"

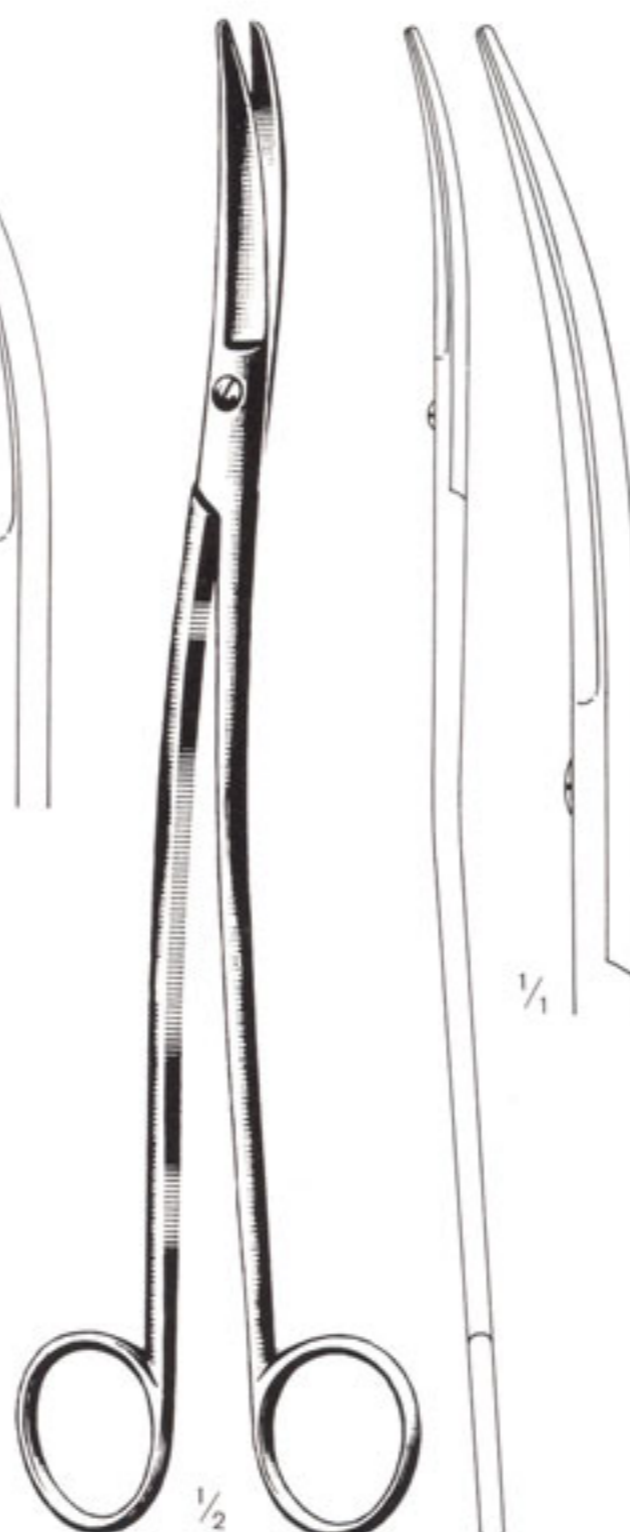

Klinkenbergh-Loth
1-379-23
23 cm/9"

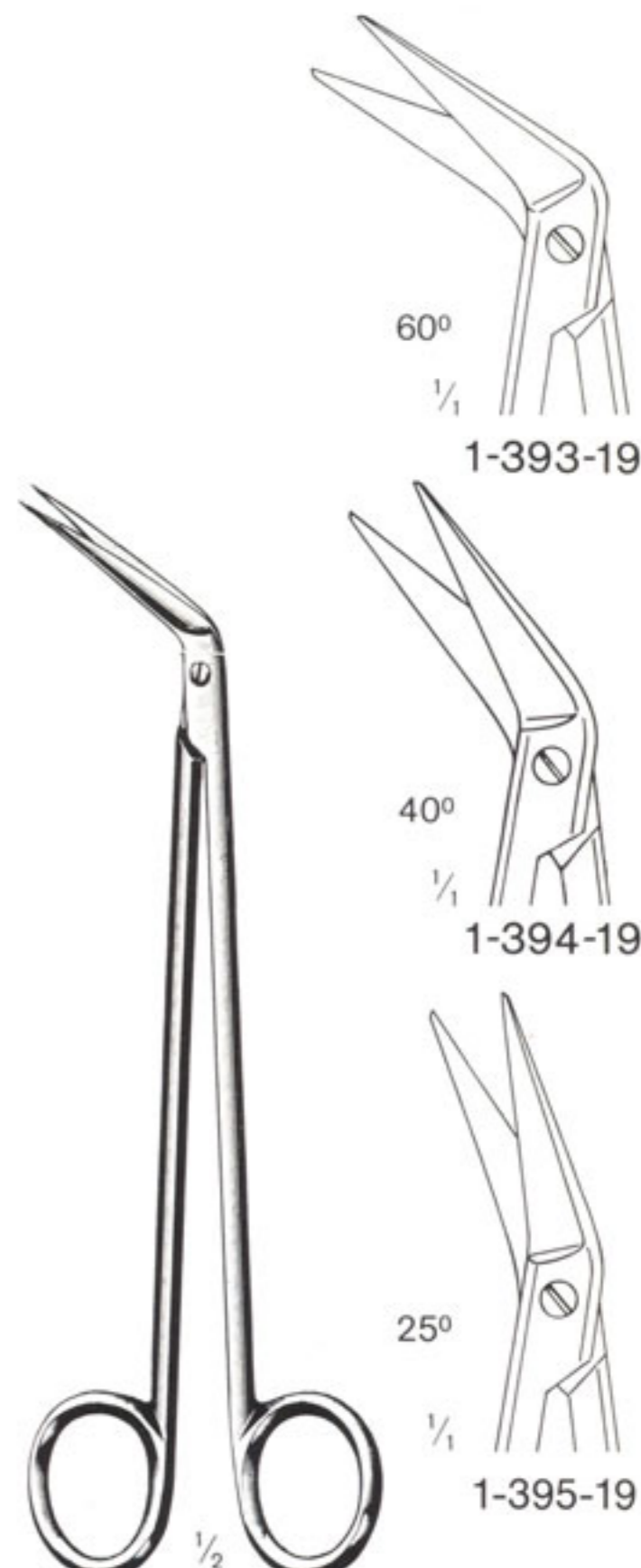

Potts-Smith
1-393-19 — 1-395-19
19 cm/7 1/2"

laterally angled

1-371-30
1-375-24 — 1-395-19

Lobectom Scissors
Artery Scissors

Thoraxscheren, Gefabscheren Scissors, Thorax and Vascular Tijeras toracicas y vasculares



Potts-de Martel
1-397-21 = 21 cm / 8 1/4"
1-397-24 = 24 cm / 9 1/2"



Mc Indoe
1-404-19
19 cm / 7 1/2"

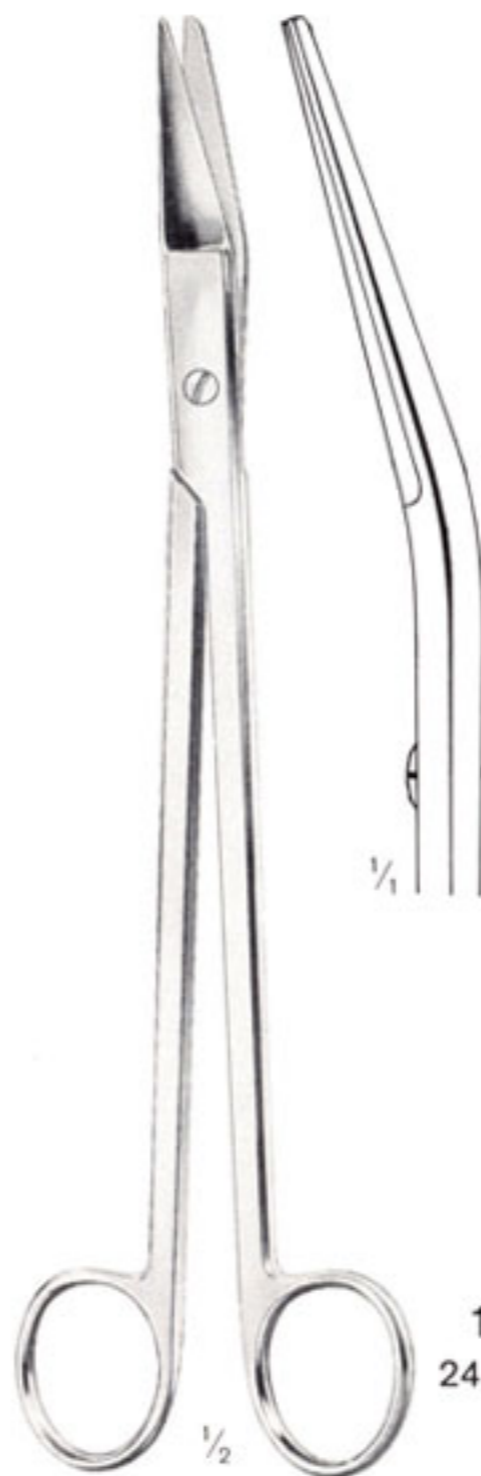

1-405-25
24,5 cm / 9 3/4"



1-414-14
14,5 cm / 5 1/2"

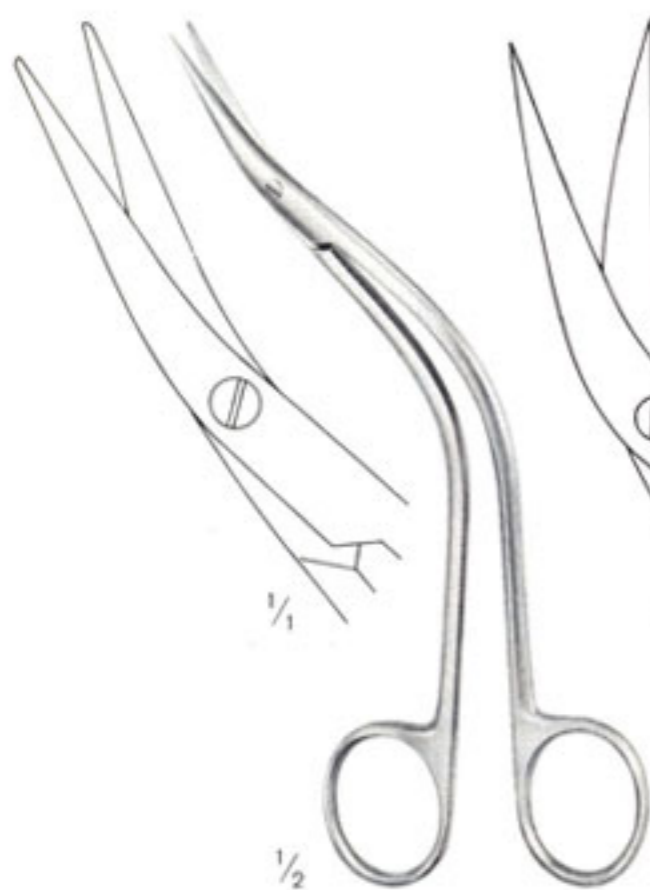

De Bakey
1-417-20
15 1/2 cm / 6"



De Bakey
1-417-45
15 1/2 cm / 6"



Favaloro
1-419-90
15 cm / 6"



1-420-11
11,5 cm / 4 1/2"

1-404-19
1-414-14
1-420-11

Cartilage Scissors
Artery Scissors
Artery and Coronary Scissors

Scheren für Neuro-und Gehirnehirnchirurgie

Brain and Neurosurgical Scissors

Tijeras para cirugía cerebral y neurocirugía

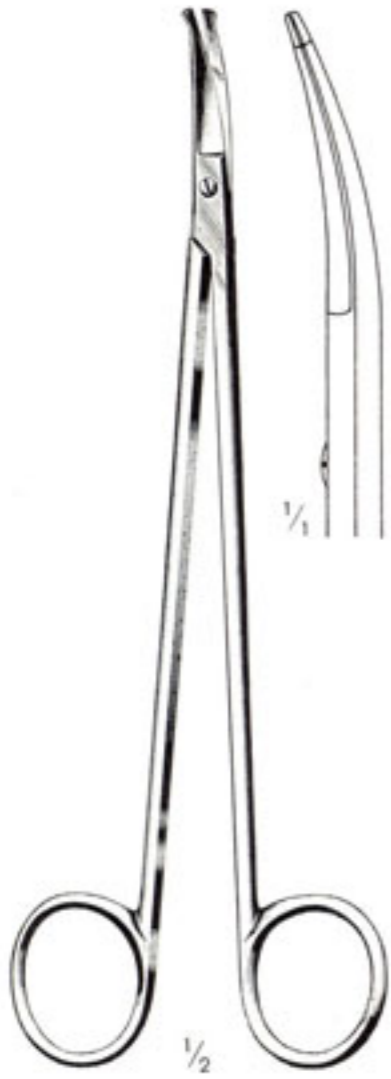

Strully
1-445-22
22 cm / 8½"



Dandy
1-451-17
17 cm / 6¾"



Schmieden-Taylor
1-455-17
17 cm / 6¾"



Toennis-Adson
1-459-17
17,5 cm / 7"



Toennis
1-466-18
18 cm / 7"



Toennis
1-467-18
18 cm / 7"



Olivecrona
1-475-23
23 cm / 9"

1-445-22– 1-451-17
1-455-17
1-459-17– 1-467-18
1-475-23

Neurosurgical Scissors
Dura Scissors
Preparation Scissors
Trigeminal Scissors (also for nose)

Tonsillen-und Nasenscheren, Episiotomie-Scheren

Tonsil ,Nasal and Episiotomy Scissors

Tijeras nasales y para amigdalas, Tijeras para episiotomia



1-485-18 - 1-499-19
 1-511-18
 1-535-14 - 1-537-22

Tonsil Scissors
 Nasal Scissor
 Perineum (Episiotomy) Scissors

Nabelschnur-Scheren, feine chirurgische Scheren
 Umbilical Scissors and, Fine Operating Scissors
 Tijeras umbilicales, Tijeras finas para cirugia



Mod. USA
 1-545-10
 10,5 cm / 4 1/4"



Busch
 1-551-16
 16 cm / 6 1/4"



1-566-13

1/2



1-567-13

13 cm / 5"



1-570-12

1/2

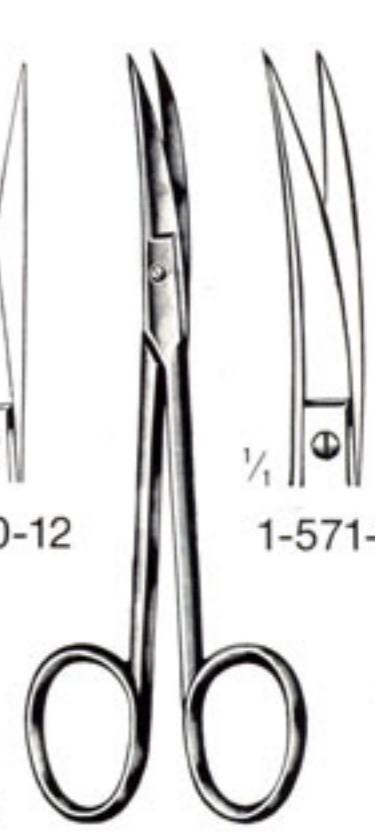

Wagner
 12 cm / 4 3/4"

1-571-12



12 cm / 4 3/4"



1-582-12



1-584-12



1-587-12



1-589-12



1-594-11
 11,5 cm / 4 1/2"



1-595-11



Locklin
 1-607-16
 16 cm / 6 1/4"



Feine chirurgische Scheren, Augenscheren Fine Operating Scissors, Eye Scissors Tijeras finas para cirugía, Tijeras oculares

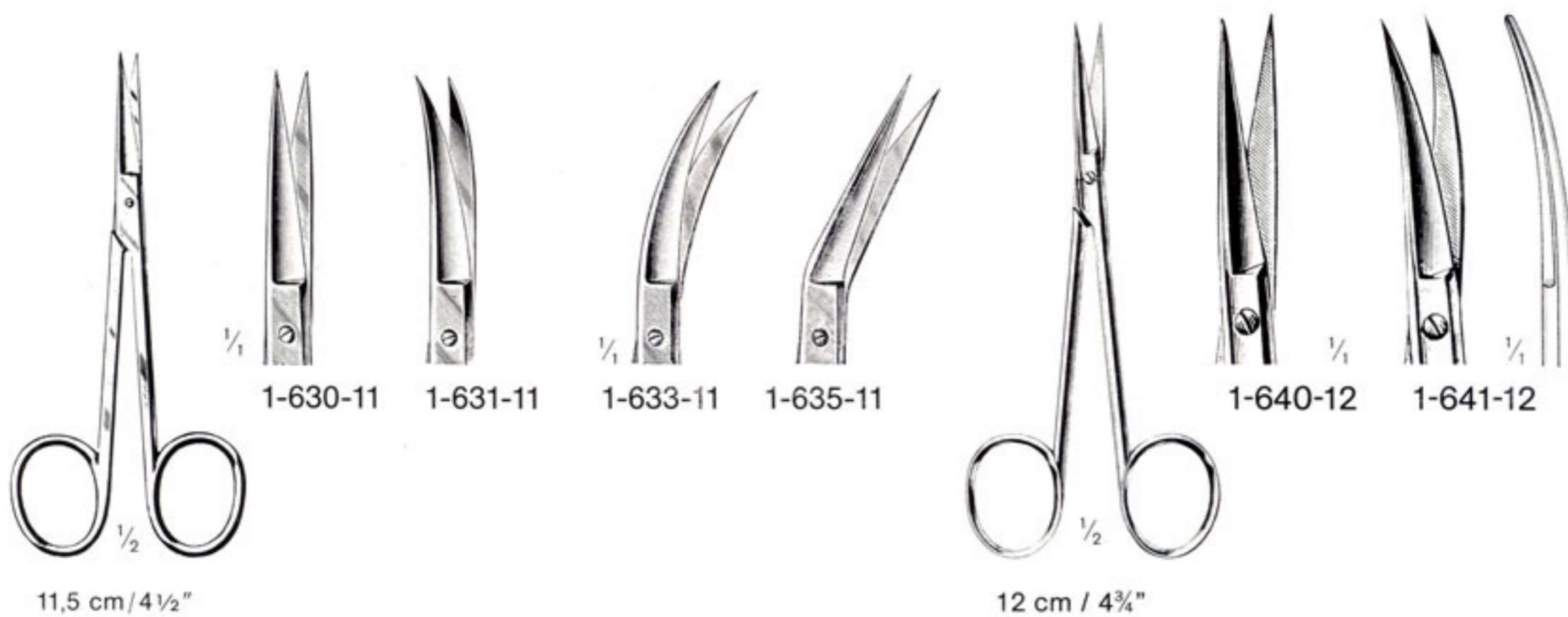
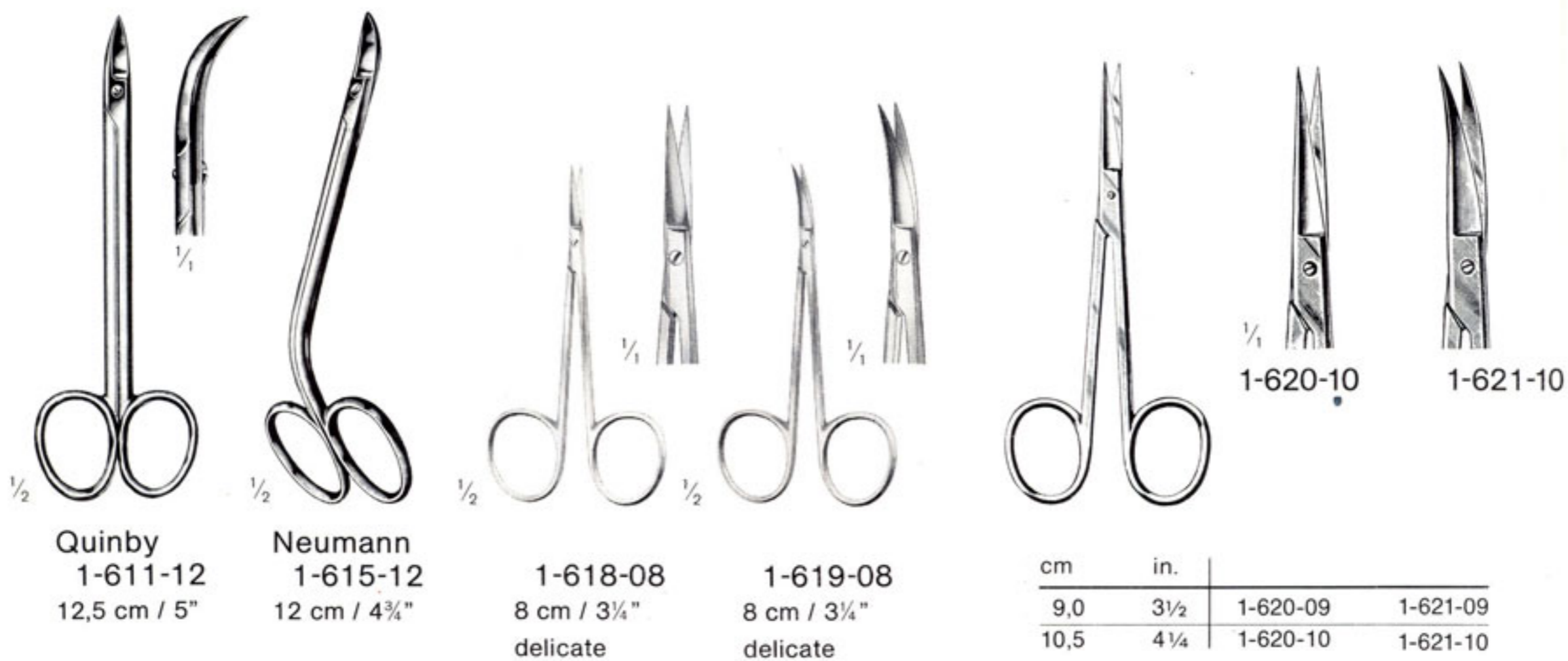

Micro-Scheren, Darmscheren, Nagelspaltscheren, Ligaturscheren
 Micro Scissors, Enterotomy, Nail splitting and Ligature Scissors
 Micro-Tijeras, Tijeras para ligaduras, para hender unas y enterotomos



1-778-01
15,5 cm / 6"



1-778-02
15,5 cm / 6"



1-782-21
21 cm / 8 1/2"



1-784-21
21 cm / 8 1/2"



1-816-13 = 13 cm / 5"
1-816-15 = 15 cm / 6"



1-819-13
13 cm / 5"



Spencer
1-824-09
9 cm / 3 1/2"



Spencer
1-826-13
13 cm / 5"



Buck
14,5 cm / 5 1/2" = 1-830-14
18 cm / 7" = 1-830-18

1-782-21 - 1-784-21
1-816-13 - 1-816-15
1-819-13 - 1-830-18

Enterotomy Scissors for anatomy
Nail Splitting Scissors
Ligature Scissors

Ligaturscheren, Fadenscheren

Ligature Scissors

Tijeras para ligaduras



Littauer
1-834-14
14 cm / 5½"



Heath
1-837-15
15 cm / 6"

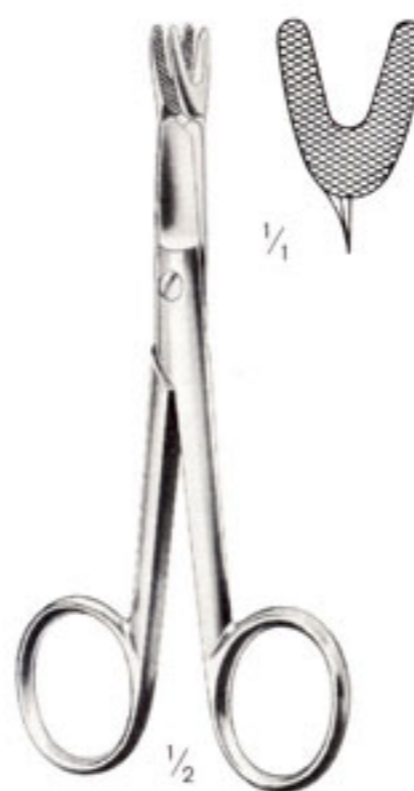

Schoemaker-Loth
1-838-13
13 cm / 5"



Eiselsberg
1-840-12
12 cm / 4¾"

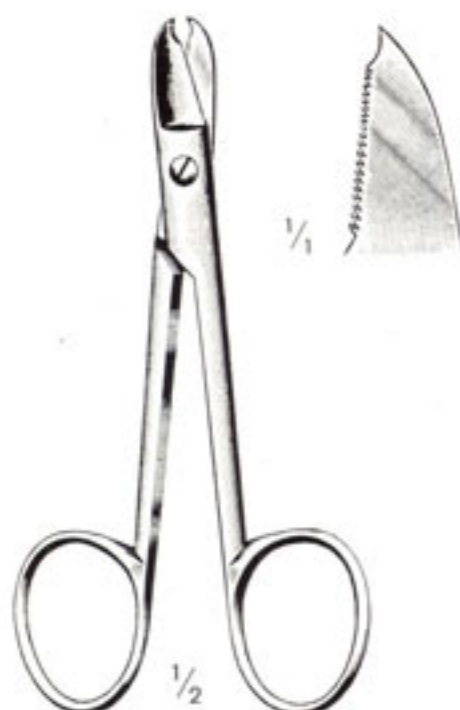

1-842-12
12 cm / 4¾"
saw edge



1-845-10
10,5 cm / 4"
saw edge



Mod. Martin
1-861-15
15,5 cm / 6"
saw edge



Harvey
1-862-12
12,5 cm / 5"

Draht-und Blechscheren

Wire and Plate Shears

Cizallas para cortar alambre y chapas metalicas



Universal
1-865-12
12 cm / 4 3/4"
saw edge



1-866-10
10 cm / 4"
saw edge

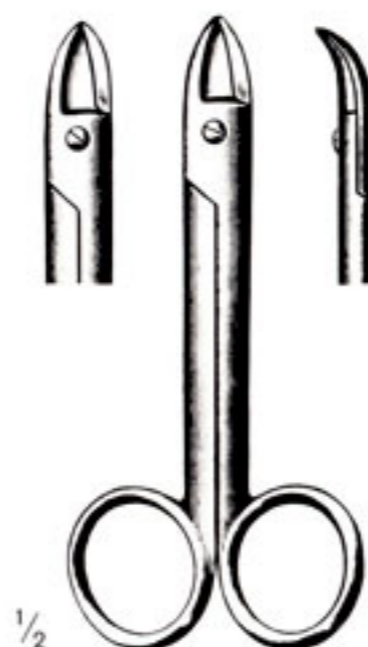

Beebe



Beebe

cm	in.	Beebe	
		blunt	sharp
10,0	4	1-870-10	1-874-10
		1-871-10	1-875-10

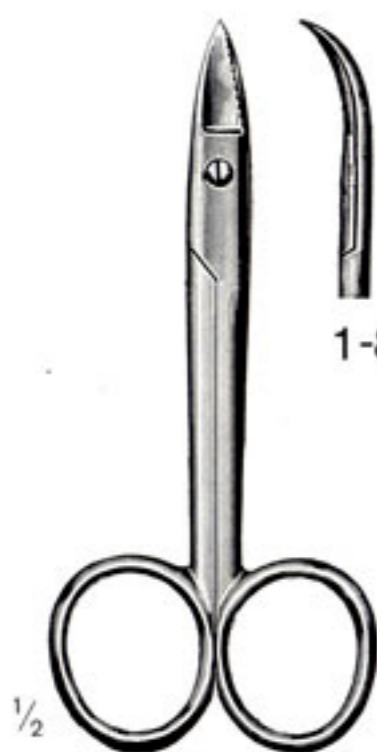

Special
1-878-12
saw edge

1-879-12



1-890-18
18 cm/7"



1-891-18

Wundhaken Retractors Separadores

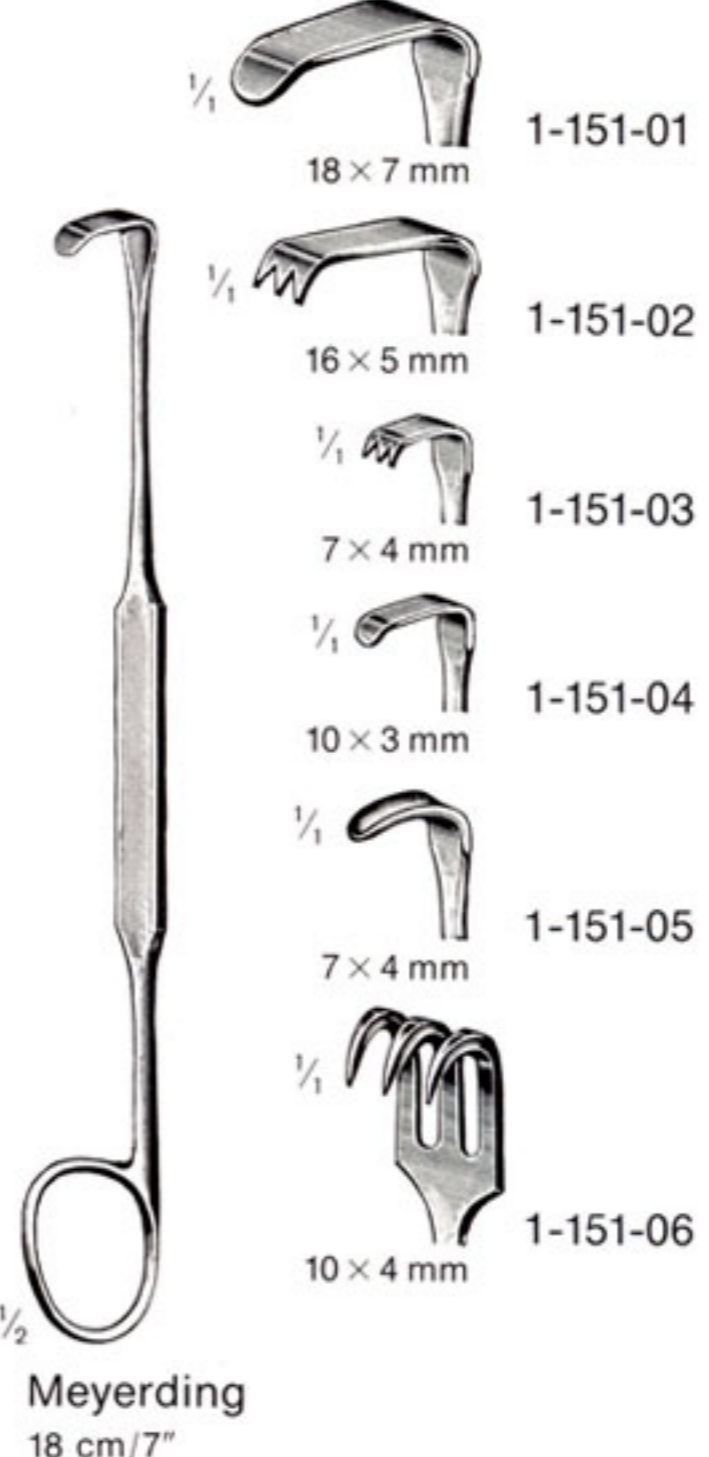
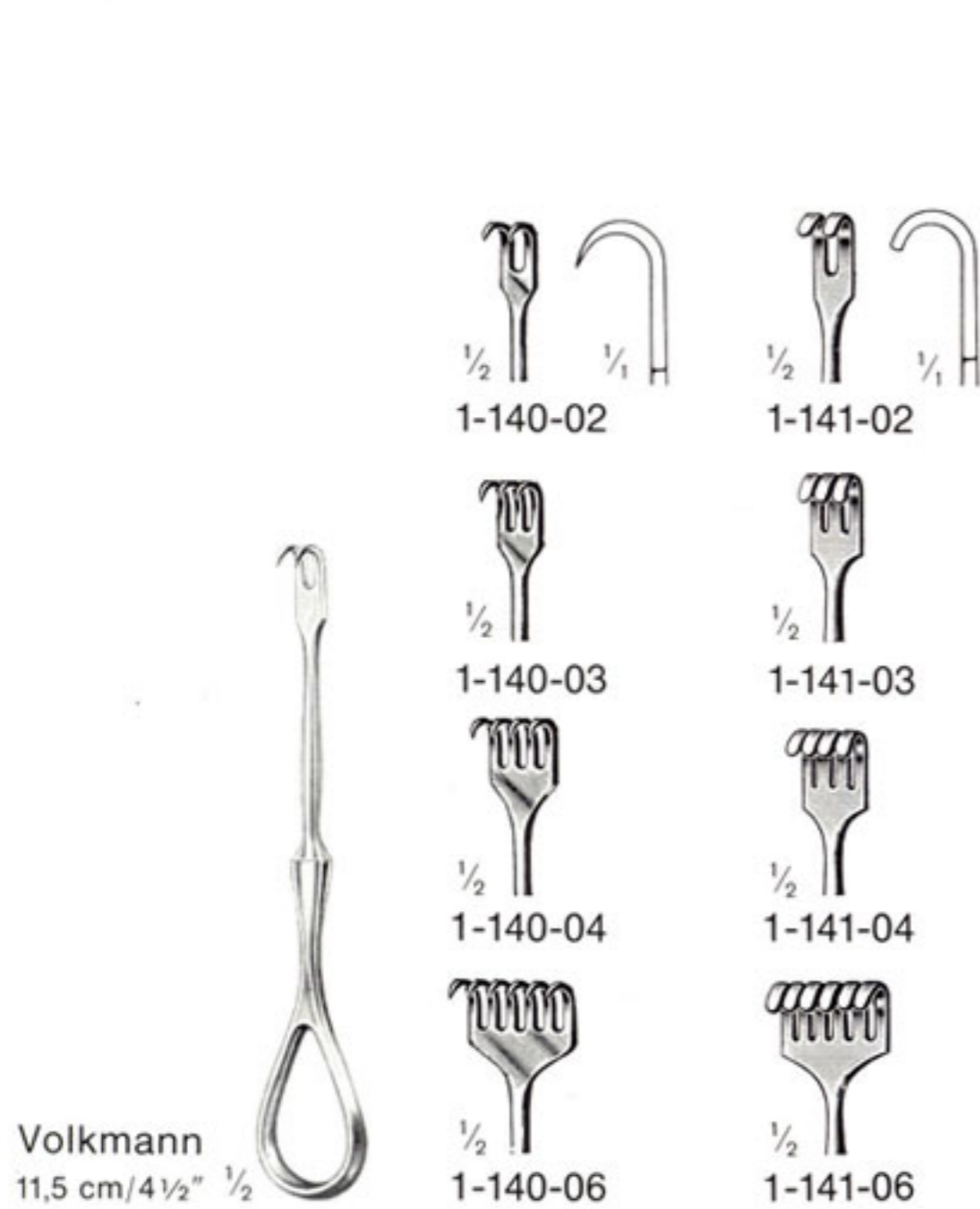
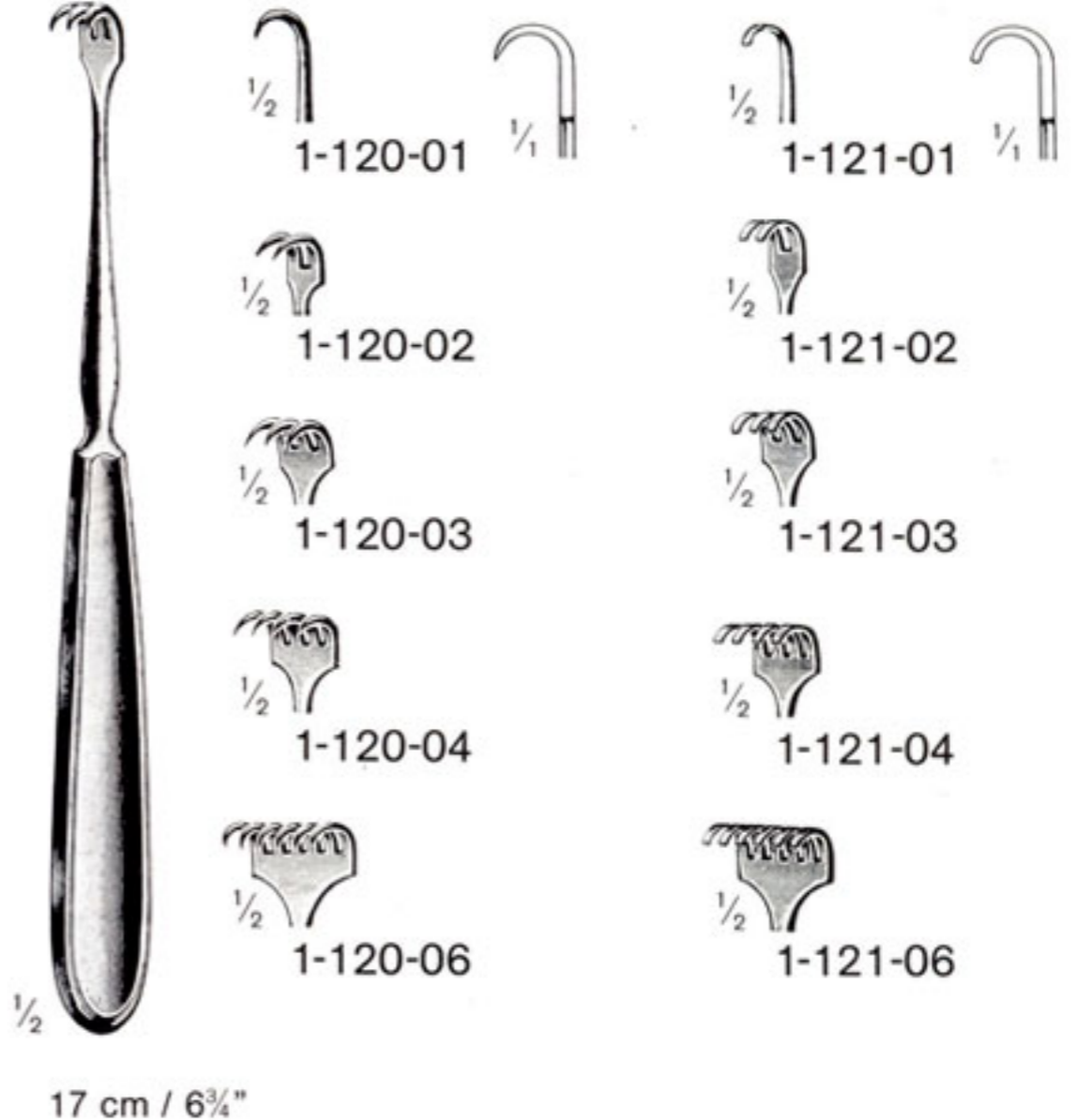
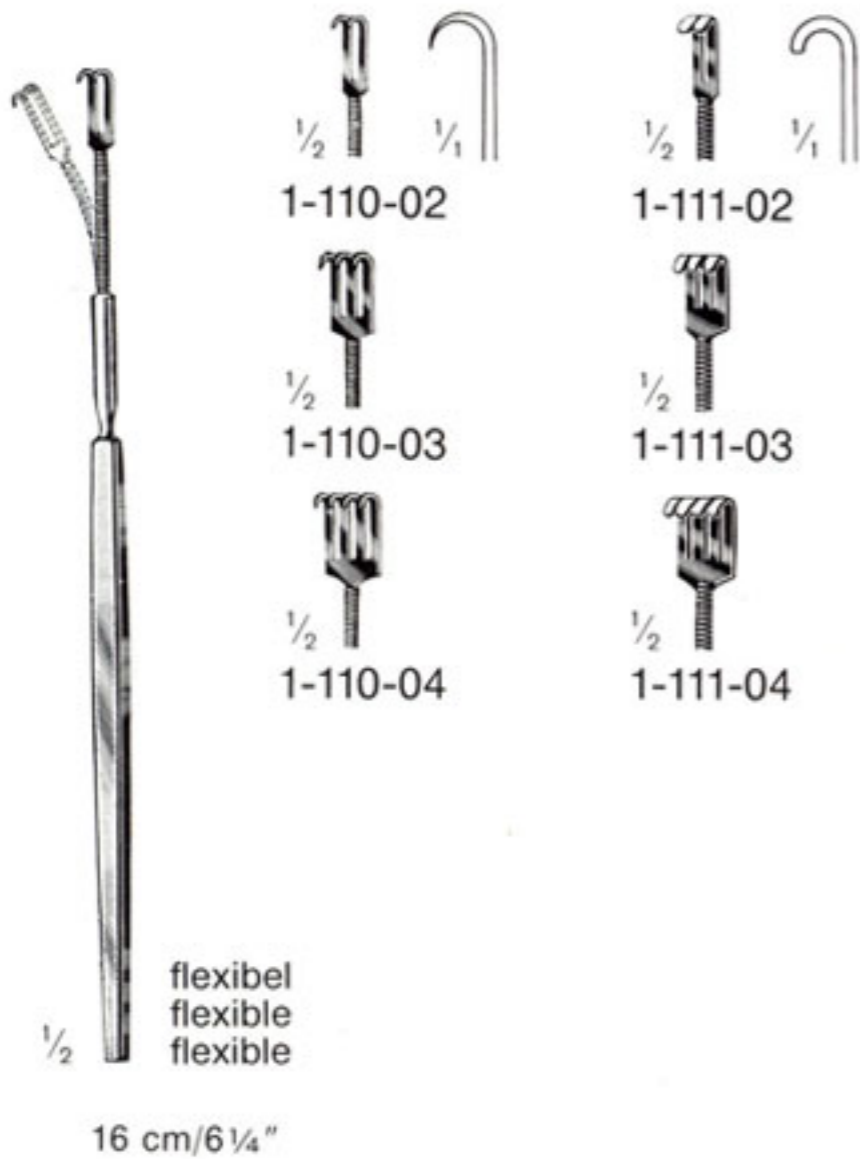

Wundhaken Retractors Separadores

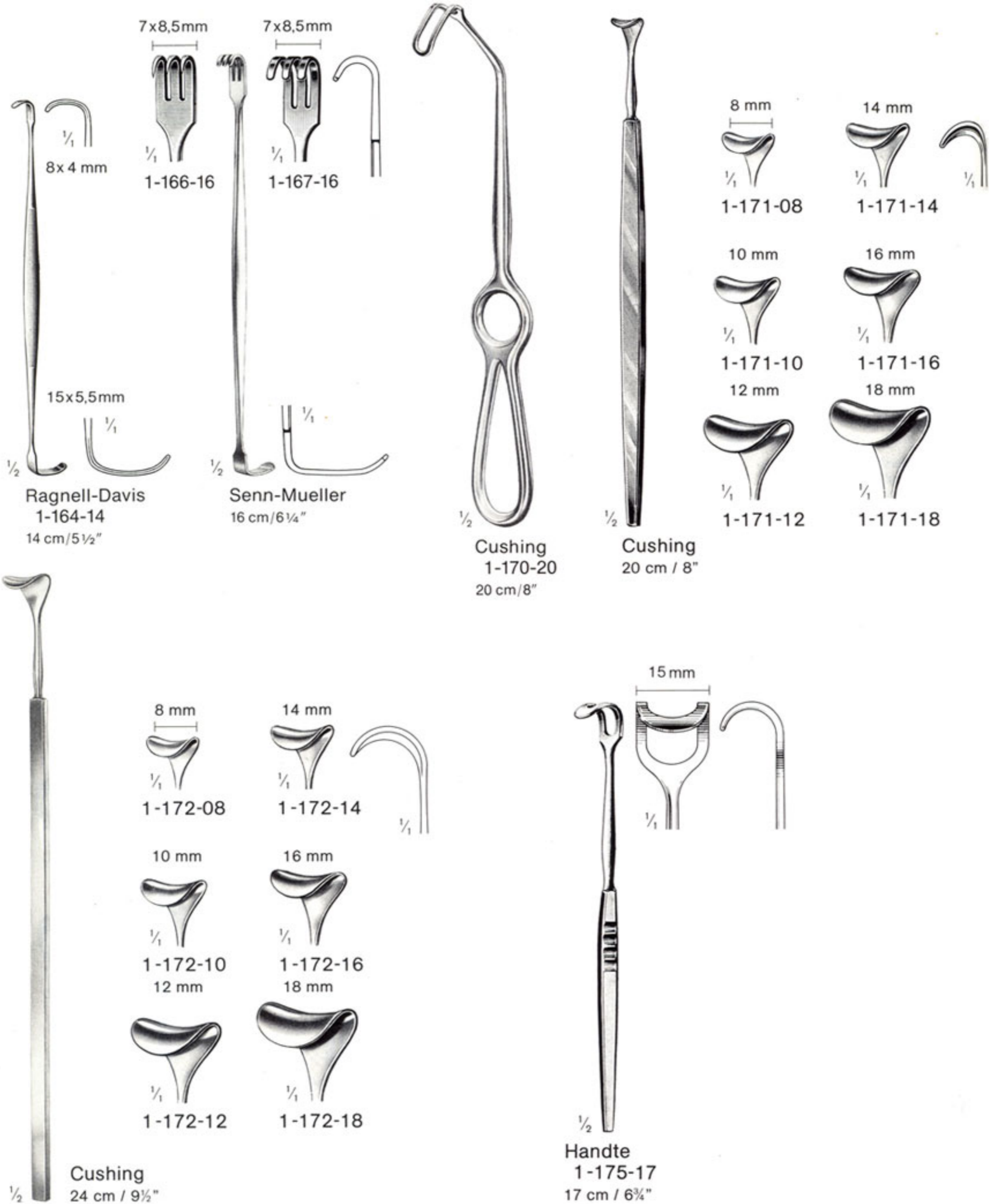

Wundhaken Retractors Separadores

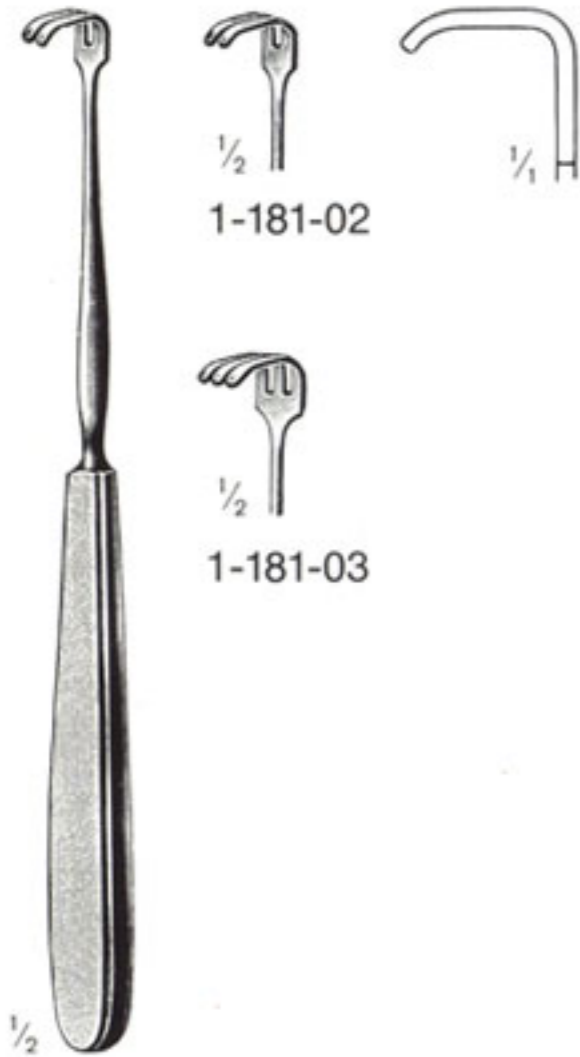

Klapp
17,5 cm/7"



Strandell-Stille
19 cm/7 1/2"

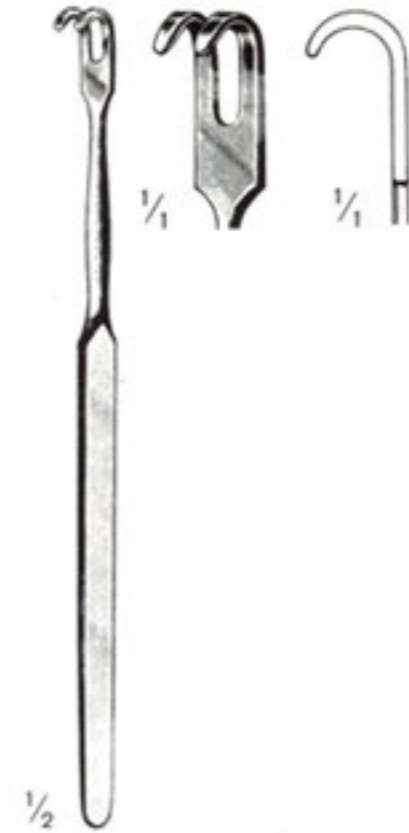

1-197-02
13,5 cm / 5 1/4"



16 cm/6 1/4"

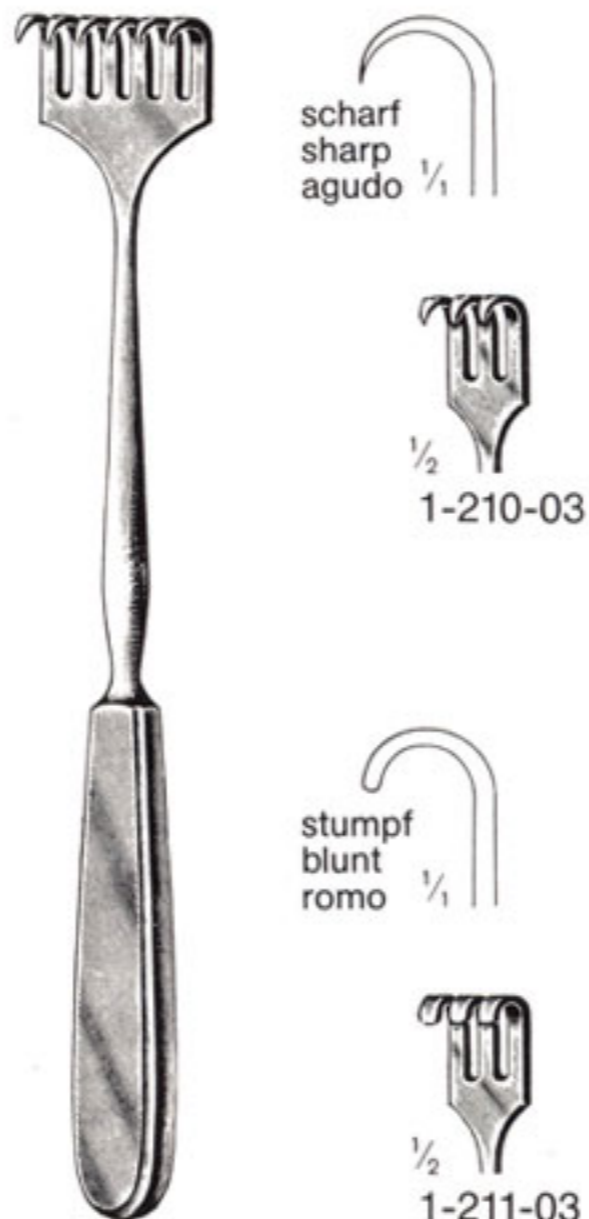

Volkmann
23 cm/9"

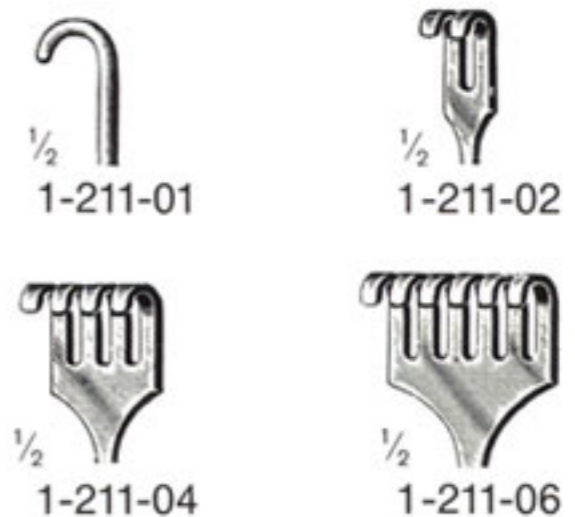
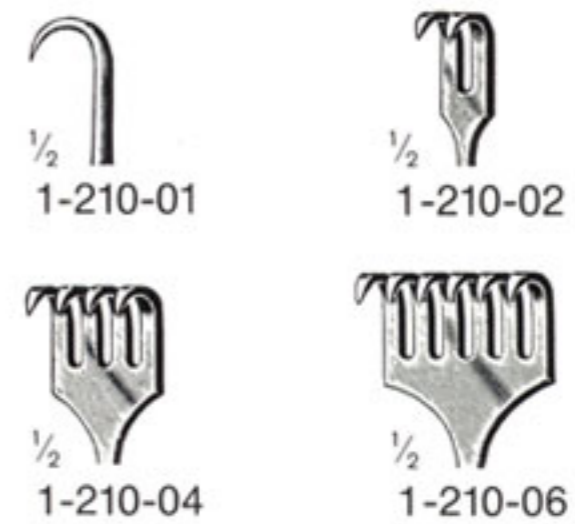

Wundhaken Retractors Separadores

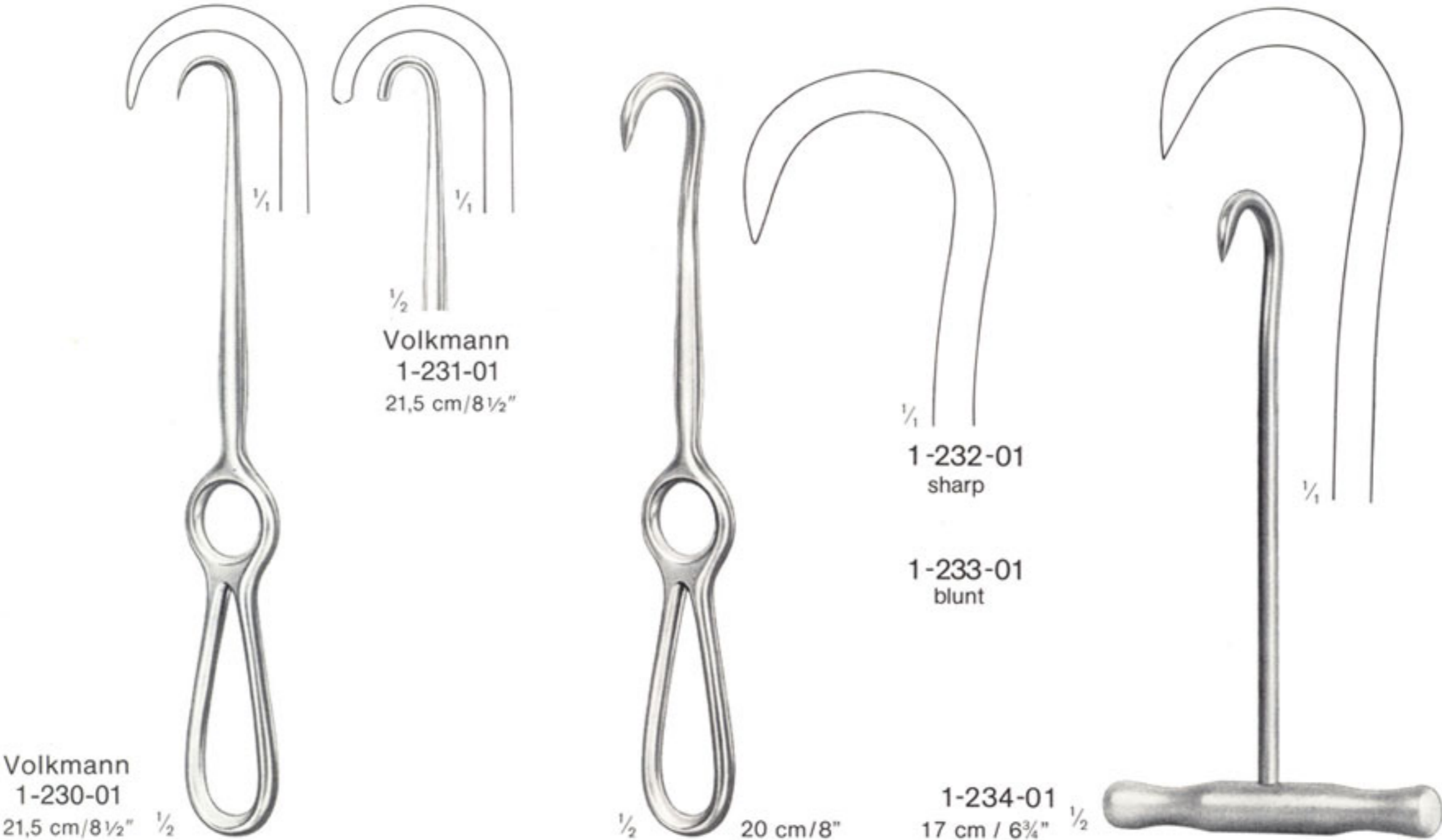

Wundhaken Retractors Separadores

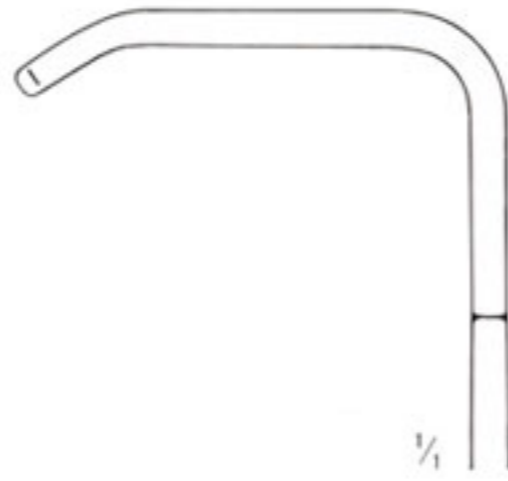
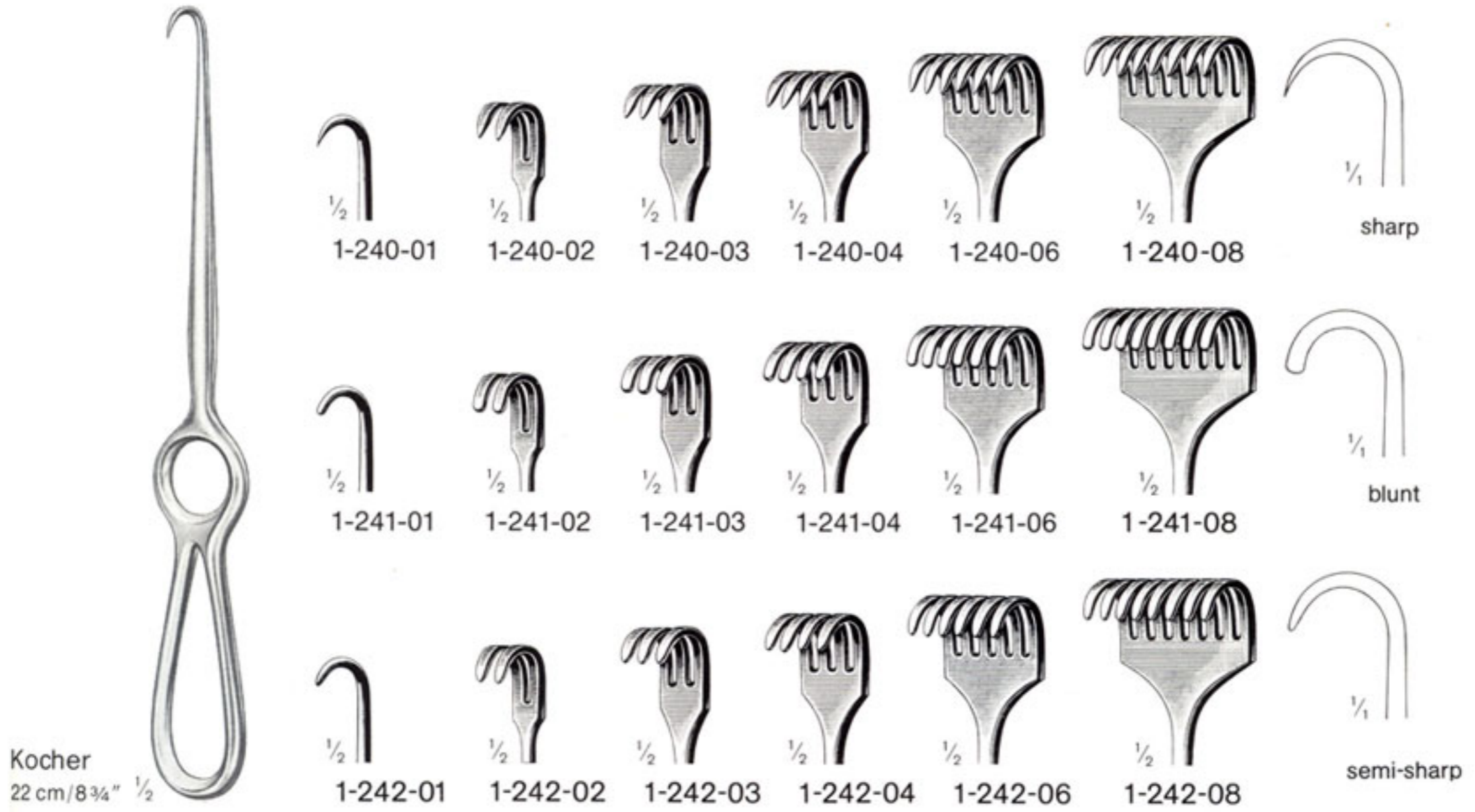

Wundhaken Retractors Separadores



Lahey
1-307-19
19 cm / 7½"



Little
1-313-20
20 cm / 8"



1-315-03
23 cm / 9¼"



Kocher
21 cm / 8¼"

Wundhaken Retractors Separadores



50 × 85 mm

1/2

Doyen
1-461-25
25 cm/10"



70 × 25 mm

1/2

Kocher
1-469-22
22,5 cm/9"



1/2

Kocher



64 × 60 mm

1/2

Tuffier
1-481-23
23 cm/9"

	Total length		Blade mm
	cm	in.	
1-471-01	25	10	80 × 45
1-471-02	25	10	80 × 55
1-471-03	25	10	80 × 65

Wundhaken Retractors Separadores



Wundhaken Retractors Separadores

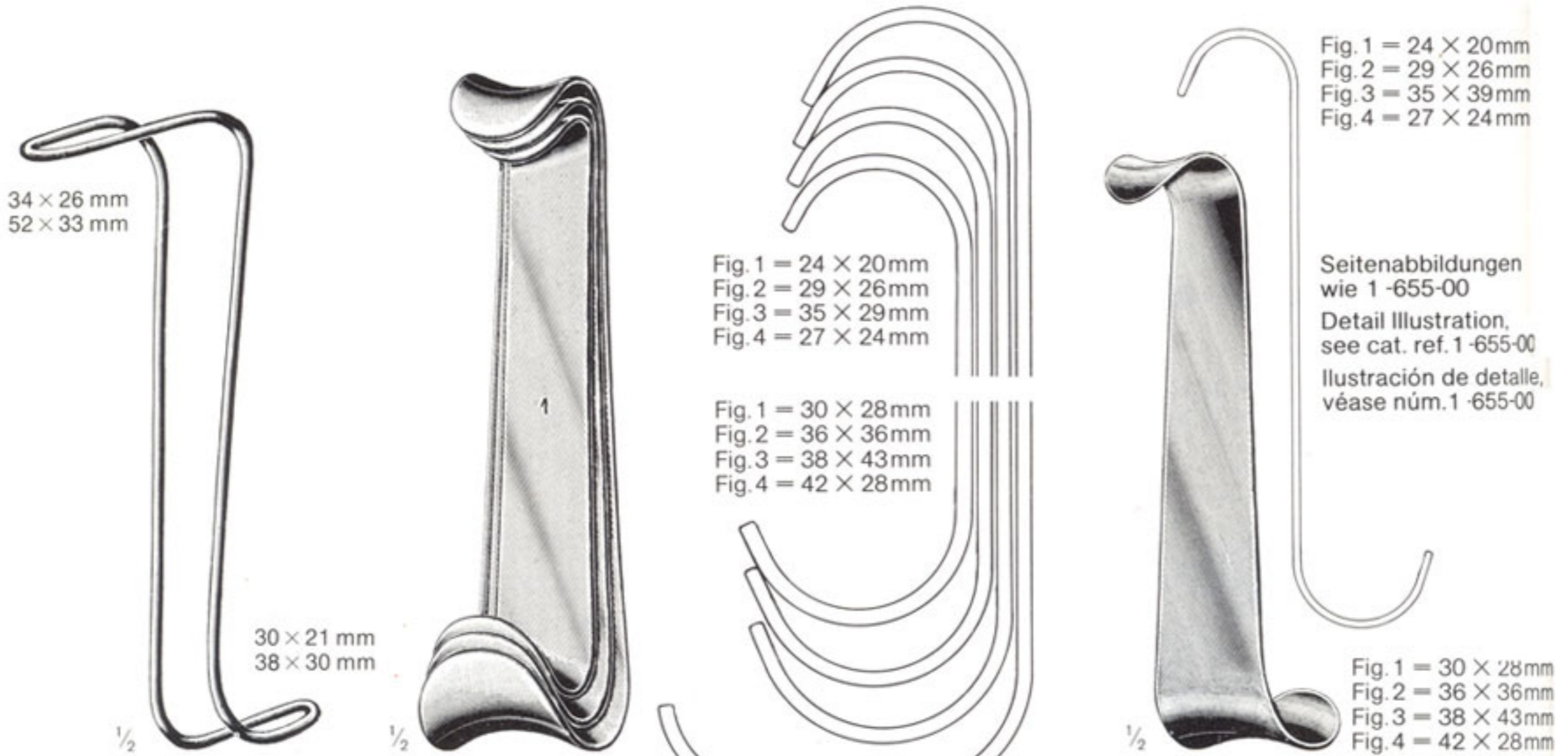

Collin-Hartmann
1-651-01 = 14 cm / 5½"
1-651-02 = 16 cm / 6¼"

Roux ½
1-655-00 = Satz · Set · Juego Fig. 1-3
1-655-01 = Fig. 1 = 14 cm / 5½"
1-655-02 = Fig. 2 = 15 cm / 6"
1-655-03 = Fig. 3 = 17 cm / 6¾"
1-655-04 = Fig. 4 = 18 cm / 7"

Roux-Magnus
1-659-00 = Satz · Set · Juego Fig. 1-3
1-659-01 = Fig. 1 = 14 cm / 5½"
1-659-02 = Fig. 2 = 15 cm / 6"
1-659-03 = Fig. 3 = 17 cm / 6¾"
1-659-04 = Fig. 4 = 18 cm / 7"

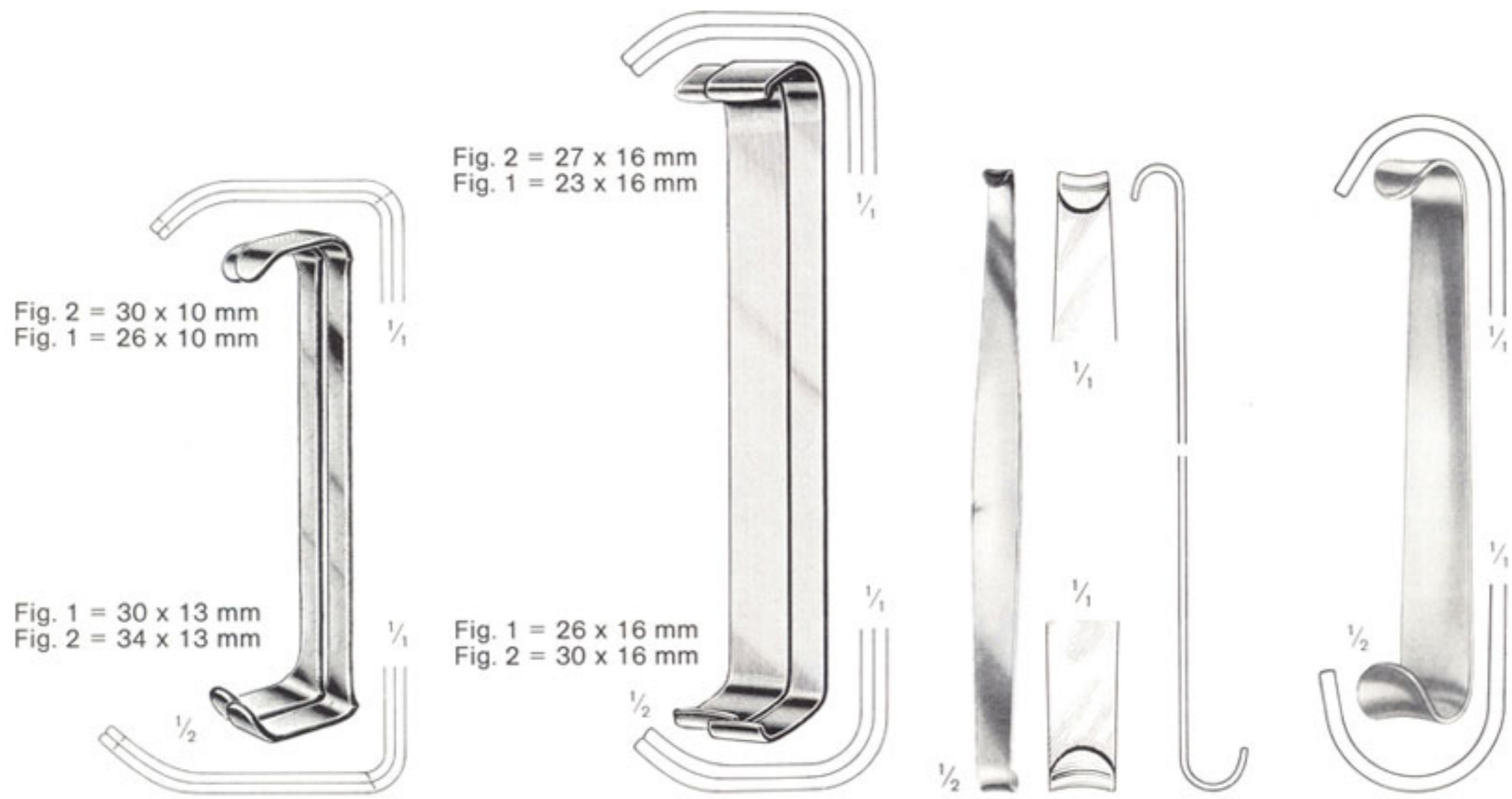

Farabeuf
12 cm / 4¾"
1-663-00 = Satz · Set · Juego
1-663-01 = Fig. 1
1-663-02 = Fig. 2

Farabeuf
15 cm / 6"
1-665-00 = Satz · Set · Juego
1-665-01 = Fig. 1
1-665-02 = Fig. 2

Mini-Roux
1-667-06

Baby-Roux
1-669-13
13 cm / 5¼"

Wundhaken Retractors Separadores

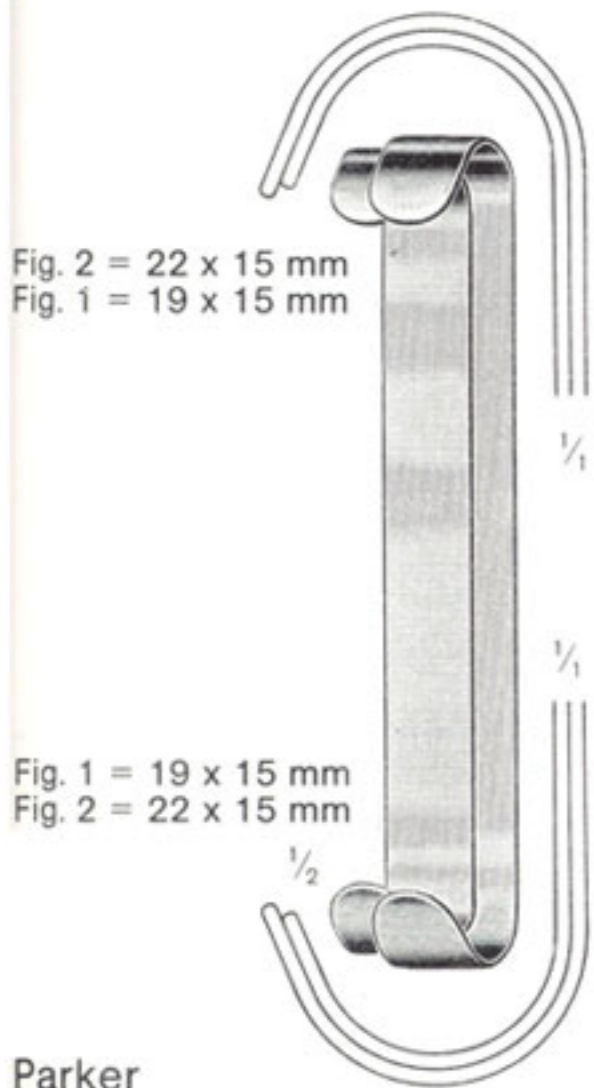

Fig. 2 = 22 x 15 mm
Fig. 1 = 19 x 15 mm

Fig. 1 = 19 x 15 mm
Fig. 2 = 22 x 15 mm

Parker
13,5 cm / 5 1/4"

1-673-01 = Satz · Set · Juego
1-673-11 = Fig. 1
1-673-12 = Fig. 2

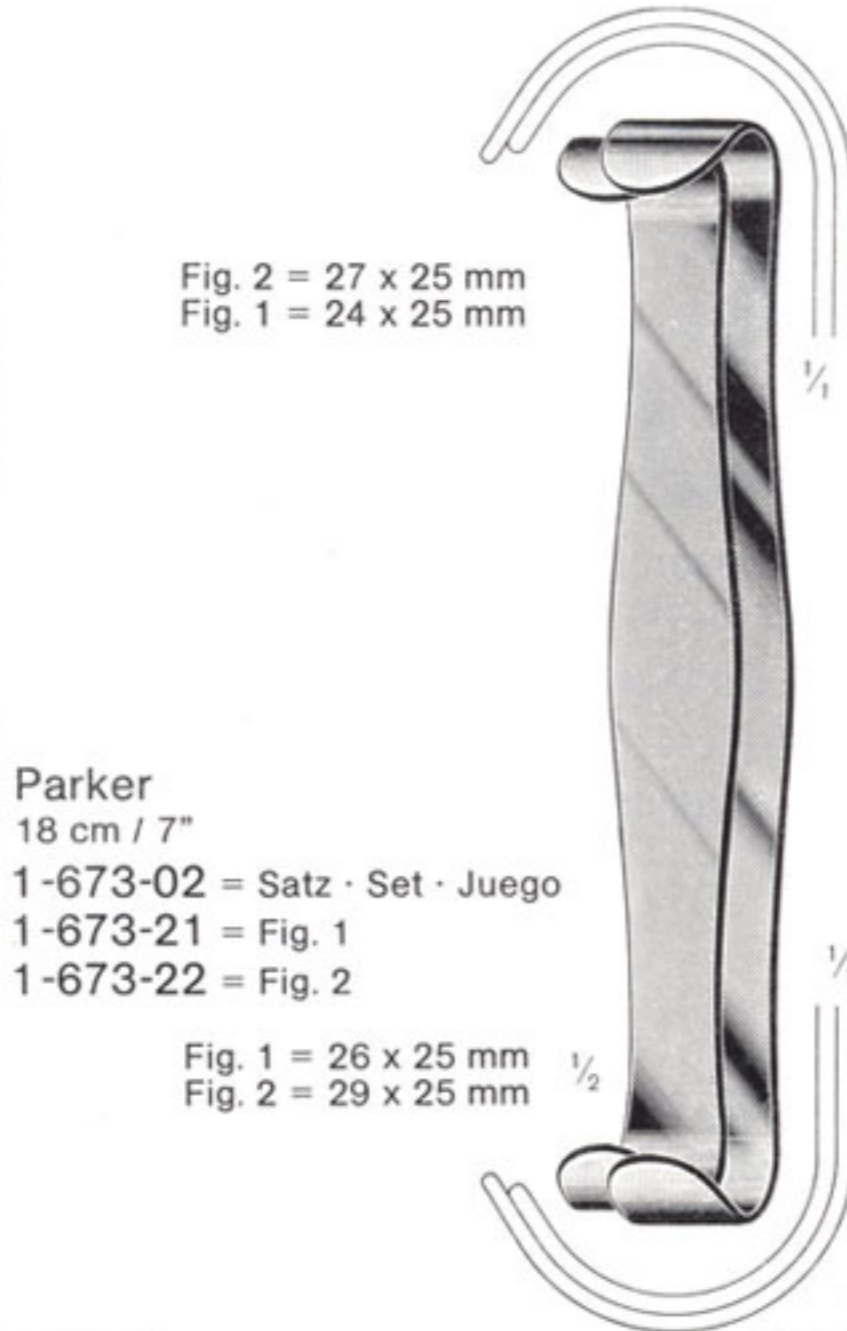

Fig. 2 = 27 x 25 mm
Fig. 1 = 24 x 25 mm

Parker
18 cm / 7"
1-673-02 = Satz · Set · Juego
1-673-21 = Fig. 1
1-673-22 = Fig. 2

Fig. 1 = 26 x 25 mm
Fig. 2 = 29 x 25 mm

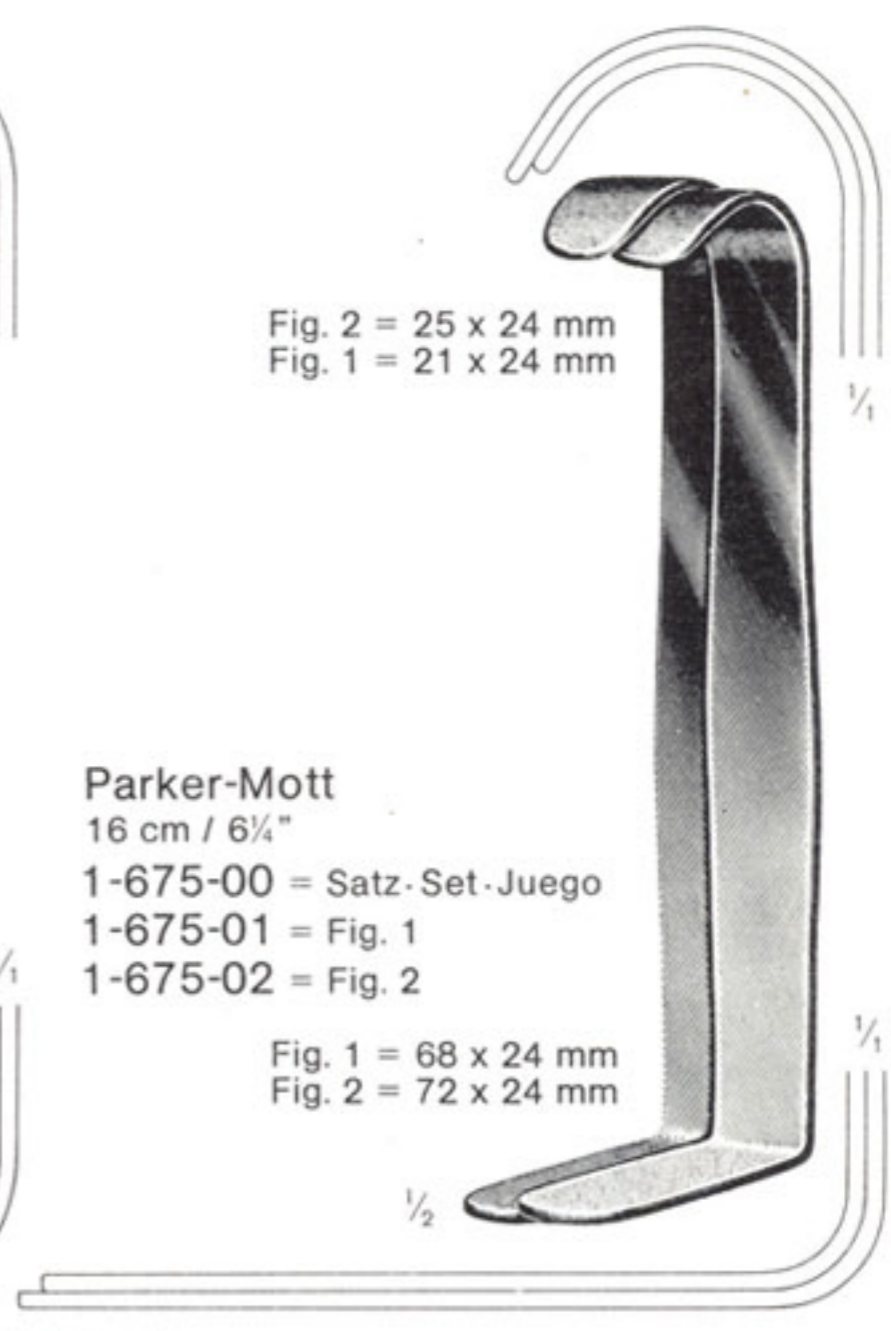

Fig. 2 = 25 x 24 mm
Fig. 1 = 21 x 24 mm

Parker-Mott
16 cm / 6 1/4"
1-675-00 = Satz · Set · Juego
1-675-01 = Fig. 1
1-675-02 = Fig. 2

Fig. 1 = 68 x 24 mm
Fig. 2 = 72 x 24 mm

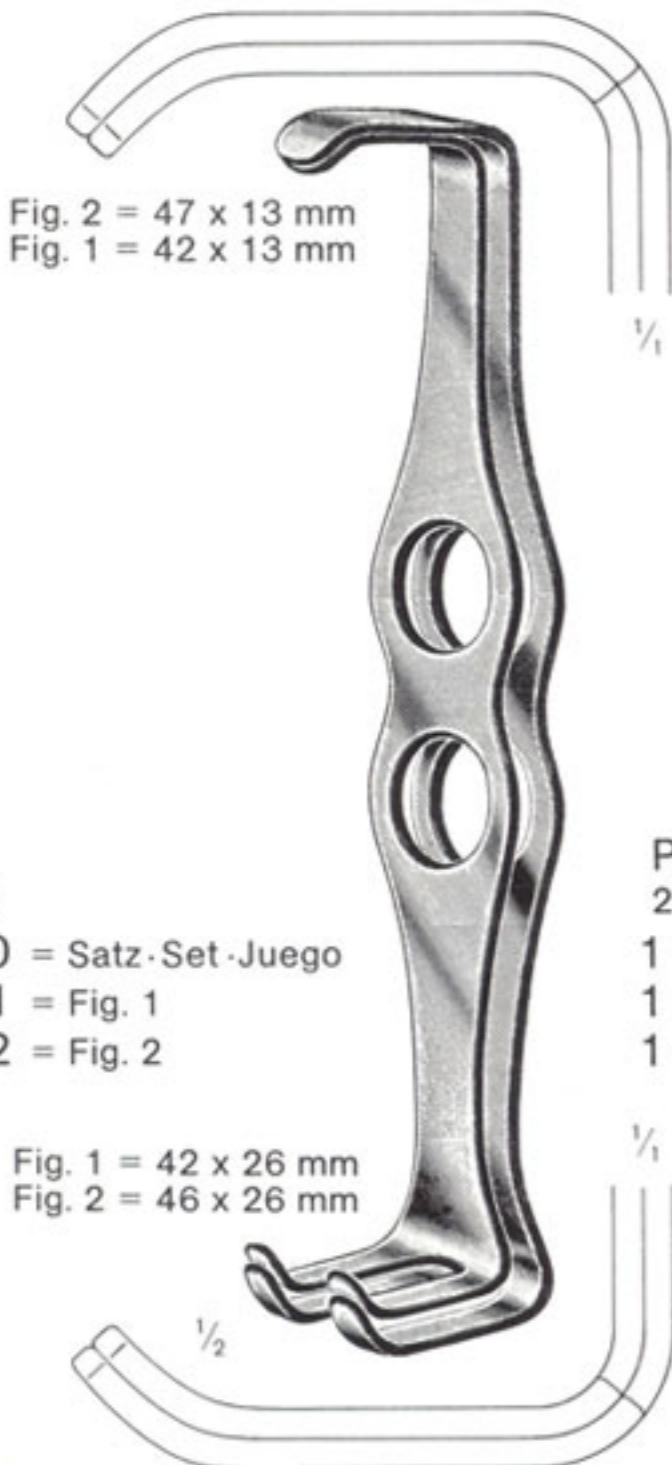

Fig. 2 = 47 x 13 mm
Fig. 1 = 42 x 13 mm

Mathieu
20 cm / 8"
1-683-00 = Satz · Set · Juego
1-683-01 = Fig. 1
1-683-02 = Fig. 2

Fig. 1 = 42 x 26 mm
Fig. 2 = 46 x 26 mm

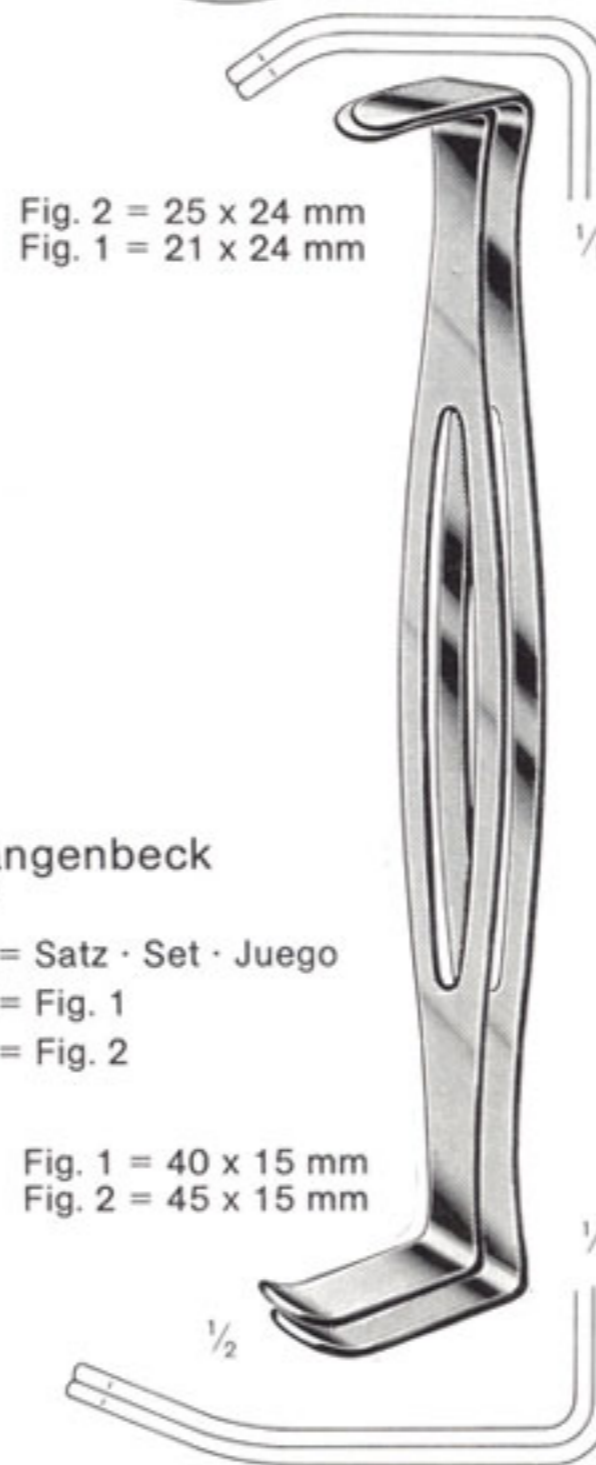

Fig. 2 = 25 x 24 mm
Fig. 1 = 21 x 24 mm

Parker-Langenbeck
21 cm / 8 1/4"
1-687-00 = Satz · Set · Juego
1-687-01 = Fig. 1
1-687-02 = Fig. 2

Fig. 1 = 40 x 15 mm
Fig. 2 = 45 x 15 mm



37 x 40 mm

Gœlet
1-695-00
19 cm / 7 1/2"

30 x 31 mm

Bauchdeckenhalter, Wundspreizer Abdominal and Vaginal Retractors Separadores abdominales, Separadores



Anderson-Adson
1-732-20
19,5 cm/8"



Weitlaner
1-734-20
20 cm/8"

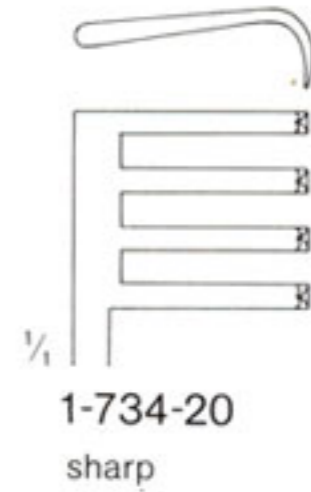

1-734-20
sharp

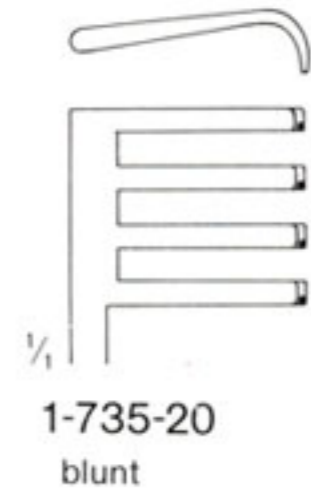

1-735-20
blunt



Adson
26,5 cm/10 1/2"

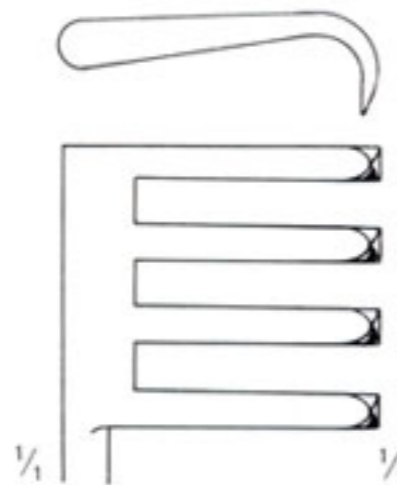

1-736-26

sharp
3 : 4 teeth

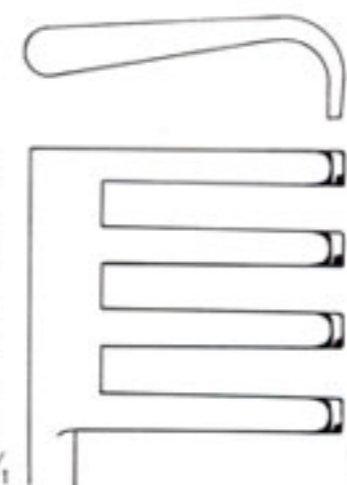

1-737-26

blunt
3 : 4 teeth

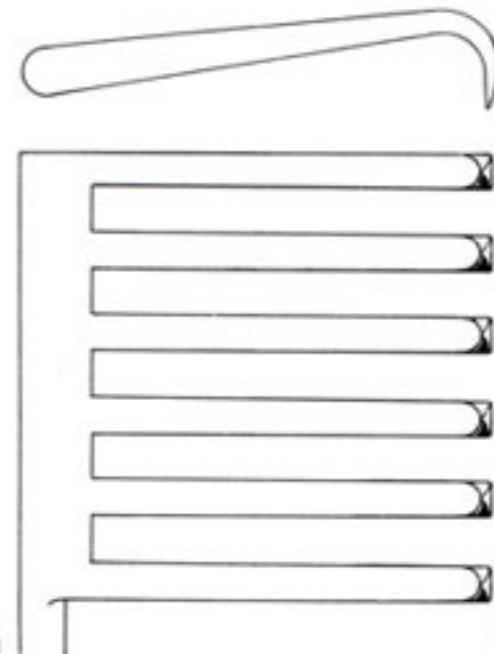

1-738-26

sharp
5 : 6 teeth

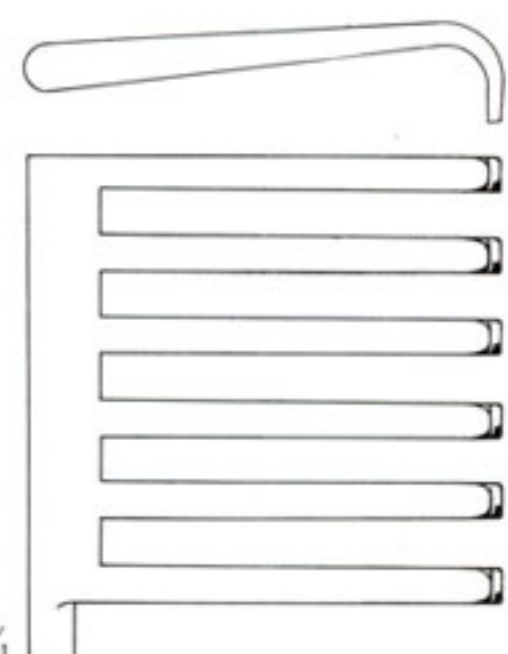

15-739-26

blunt
5 : 6 teeth

Bauchdeckenhalter, Wundspreizer Abdominal and Vaginal Retractors Separadores abdominales, Separadores

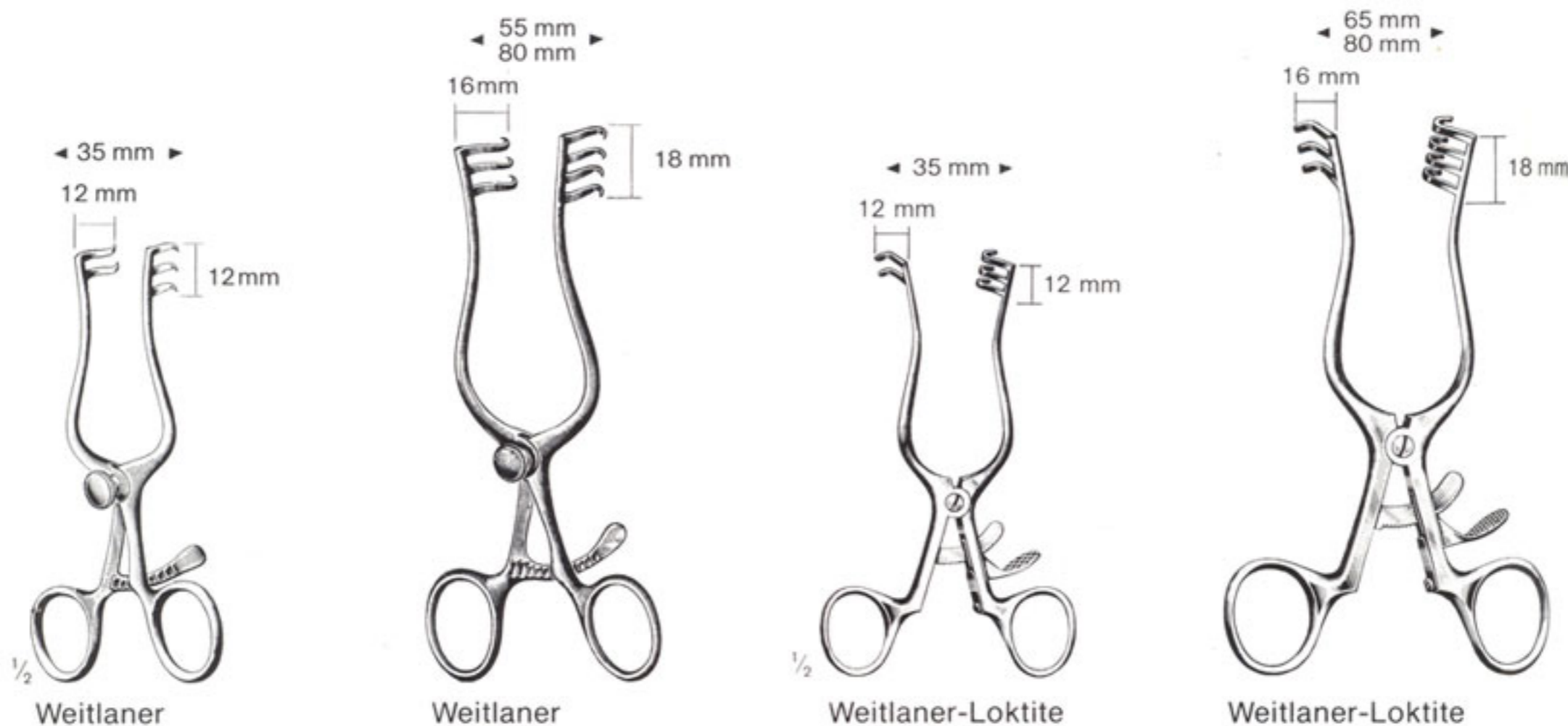

sharp	cm	in.	blunt
1-740-10	10,5	4 1/4	1-741-10

sharp	cm	in.	blunt
1-744-13	13,0	5	1-745-13
1-744-16	16,5	6 1/2	1-745-16

sharp	cm	in.	blunt
1-748-10	10,5	4 1/4	1-749-10

sharp	cm	in.	blunt
1-750-13	13,0	5	1-751-13
1-750-16	16,5	6 1/2	1-751-16

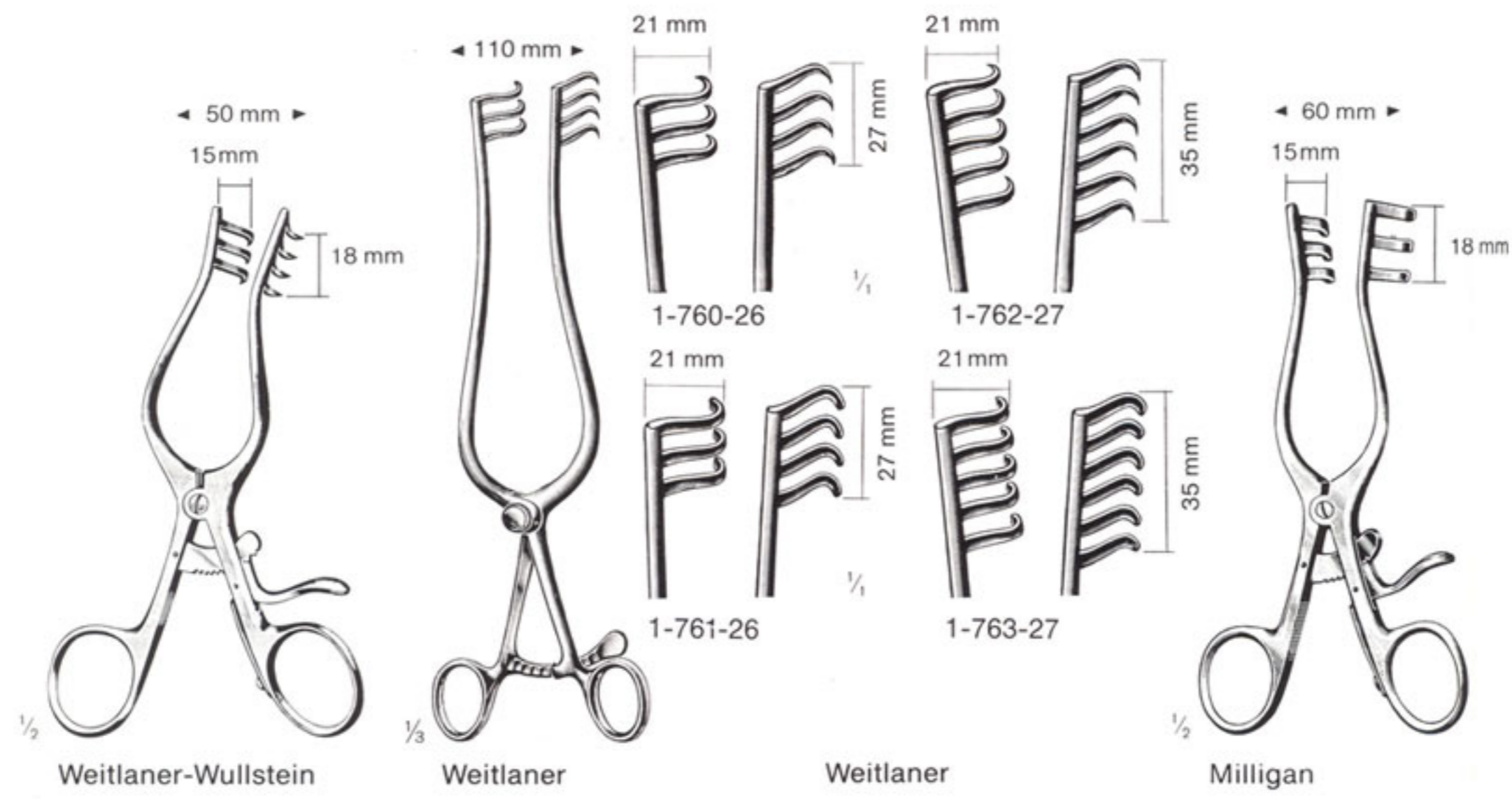

sharp	cm	in.	blunt
1-752-13	13,0	5	1-753-13

sharp	cm	in.	blunt
1-760-26	26,0	10 1/4	1-761-26

sharp	cm	in.	blunt
1-762-27	27,0	10 1/2	1-763-27

blunt	cm	in.
1-765-13	13,0	5

Bauchdeckenhalter, Wundspreizer Abdominal and Vaginal Retractors Separadores abdominales, Separadores

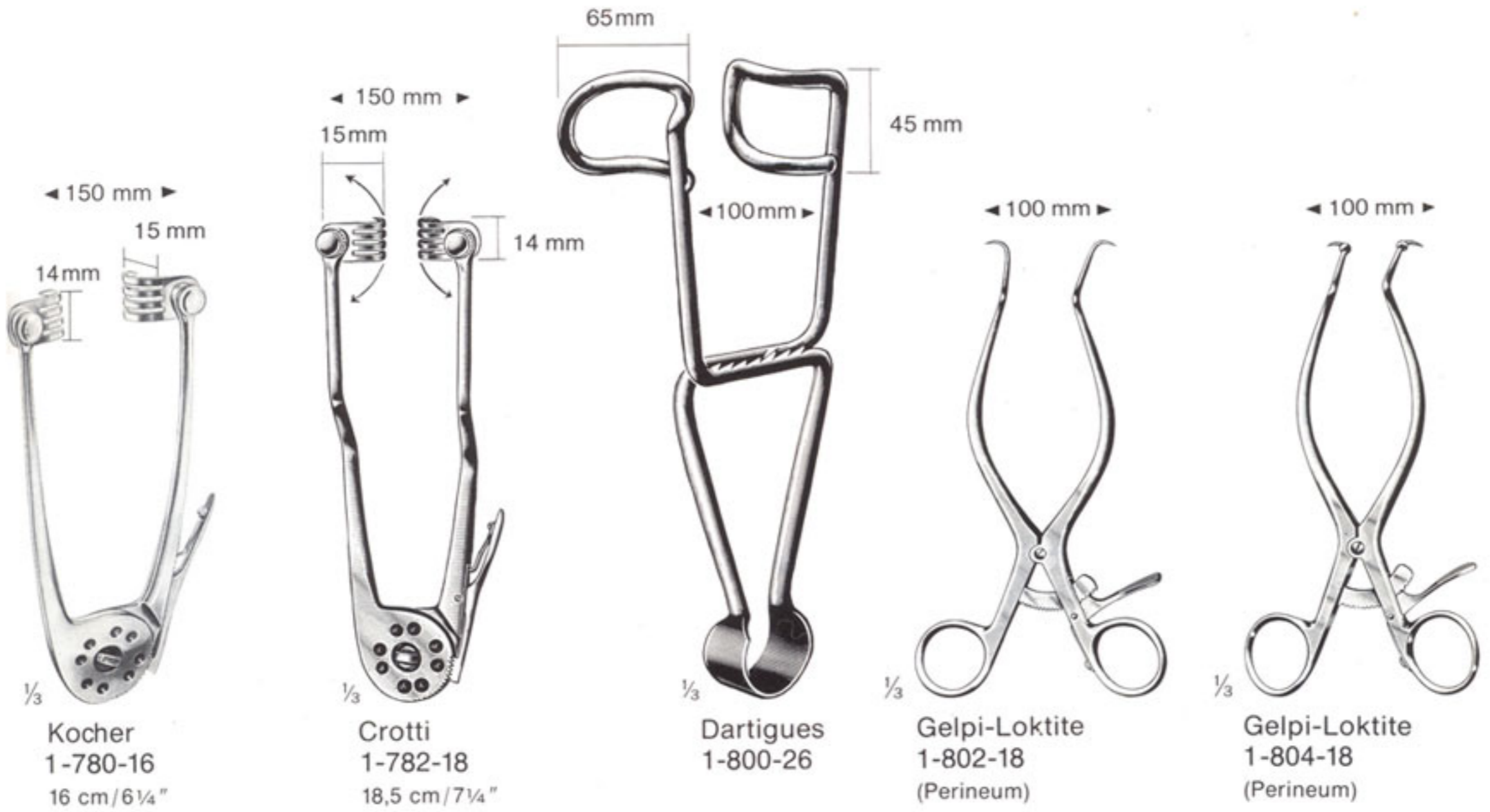

Bauchdeckenhalter, Wundspreizer Abdominal and Vaginal Retractors Separadores abdominales, Separadores

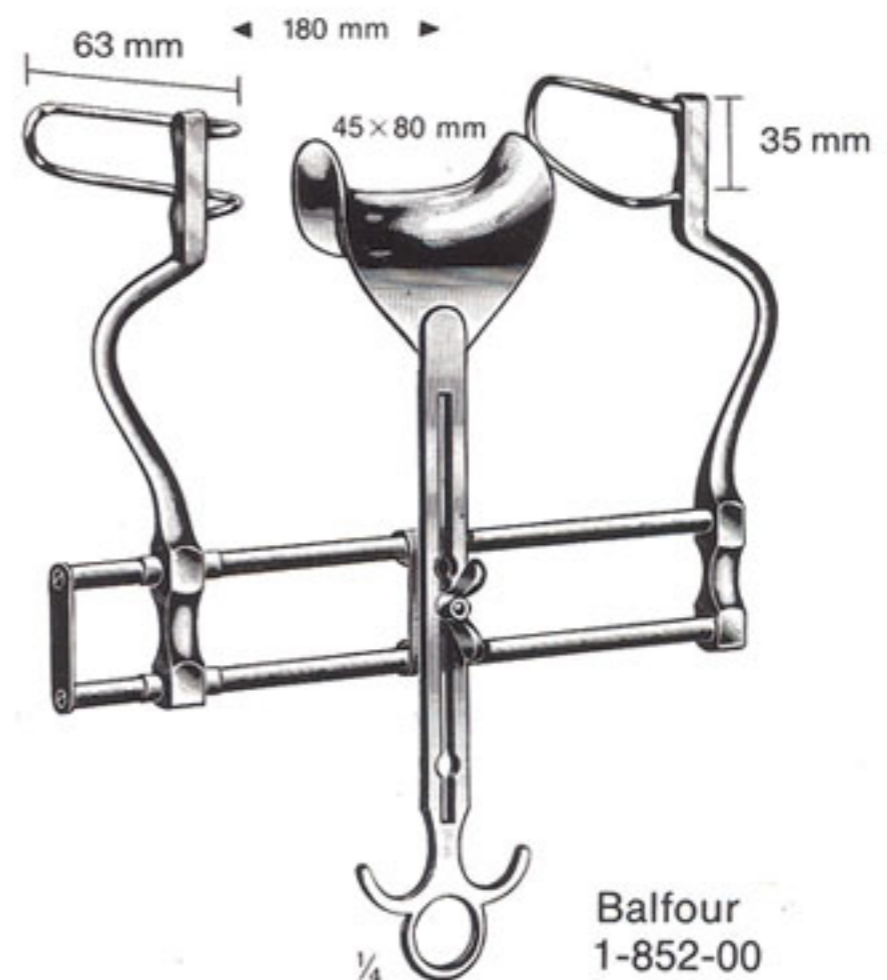
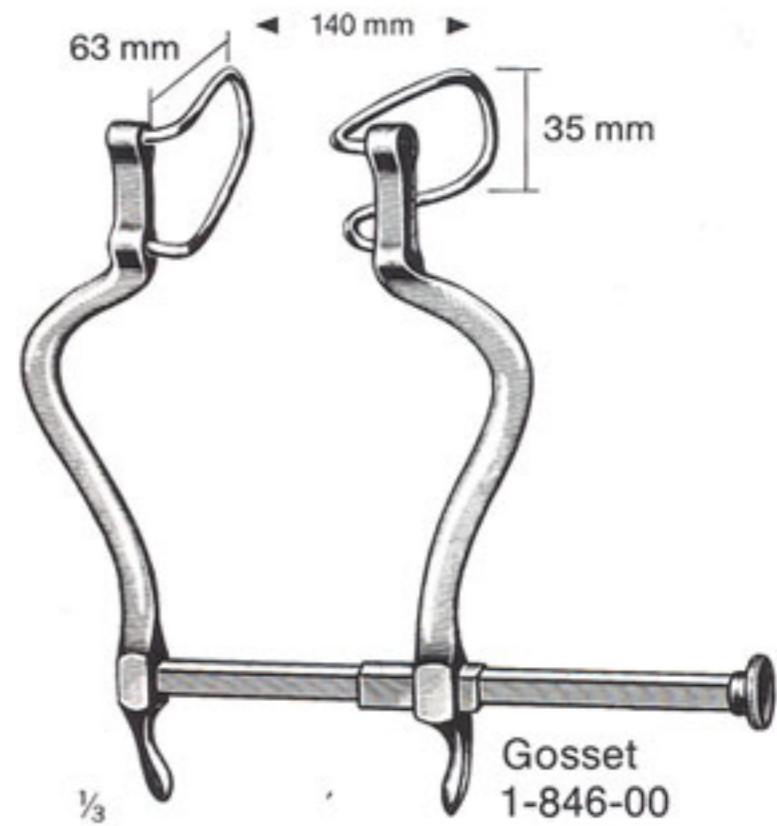
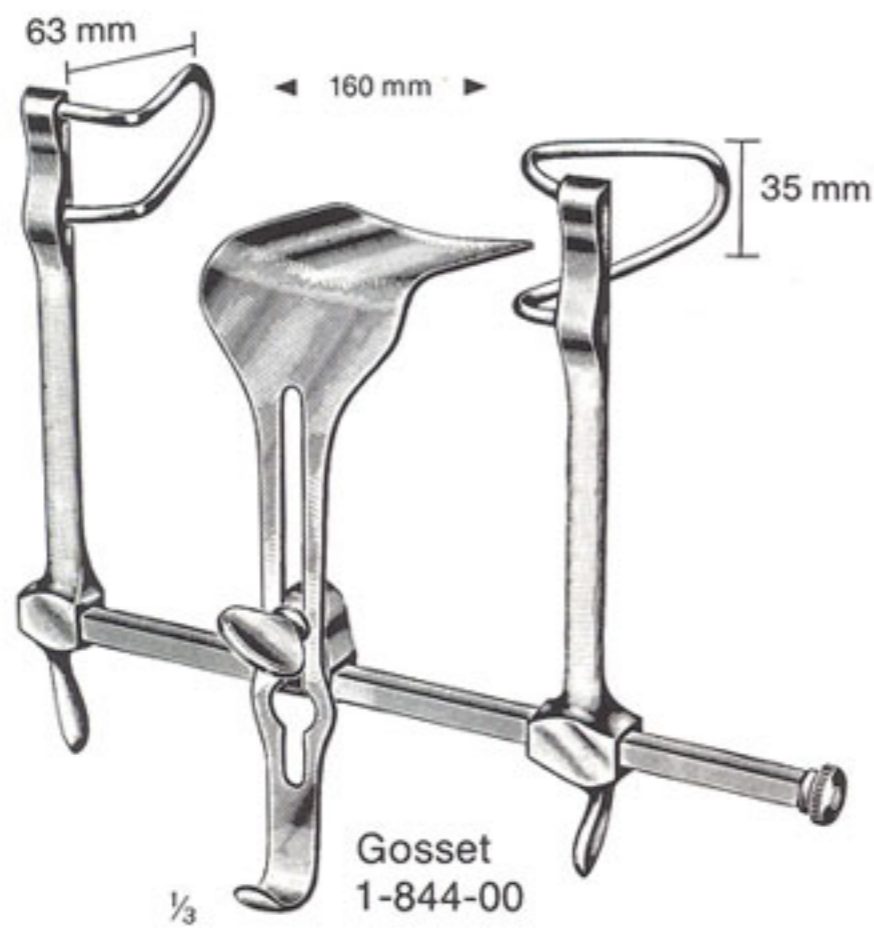
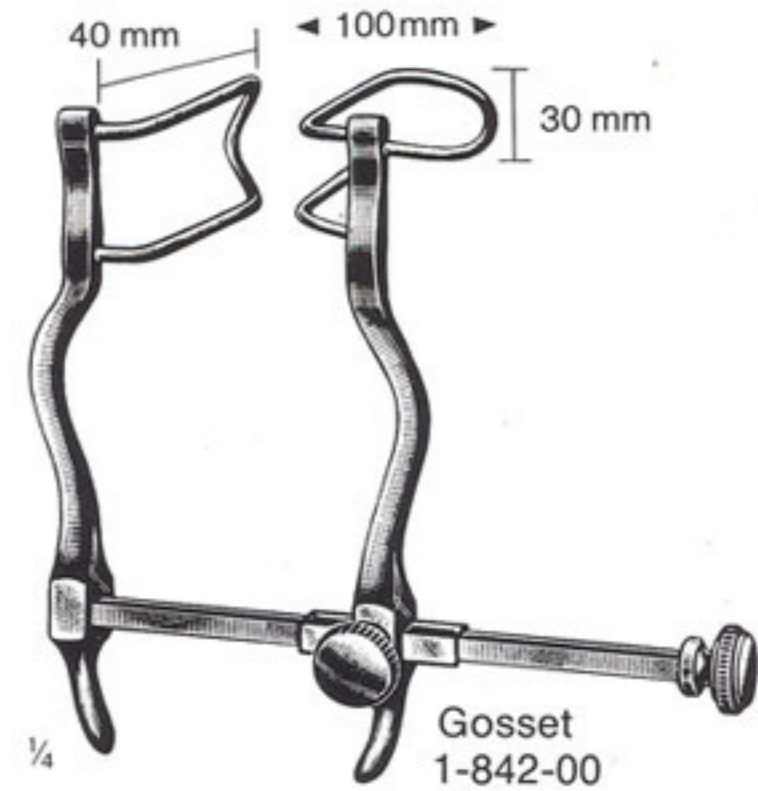
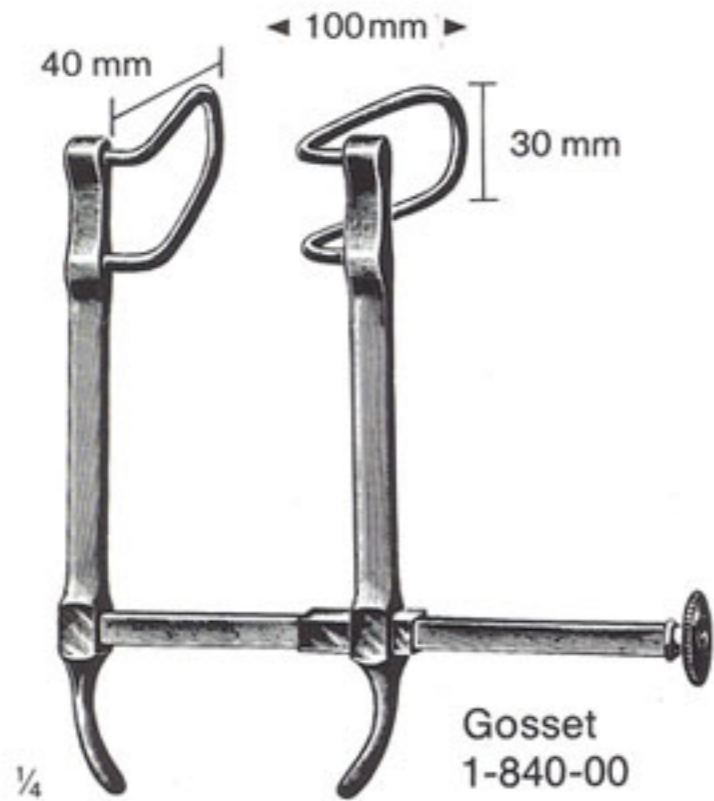

Bauchdeckenhalter, Wundspreizer Abdominal and Vaginal Retractors Separadores abdominales, Separadores

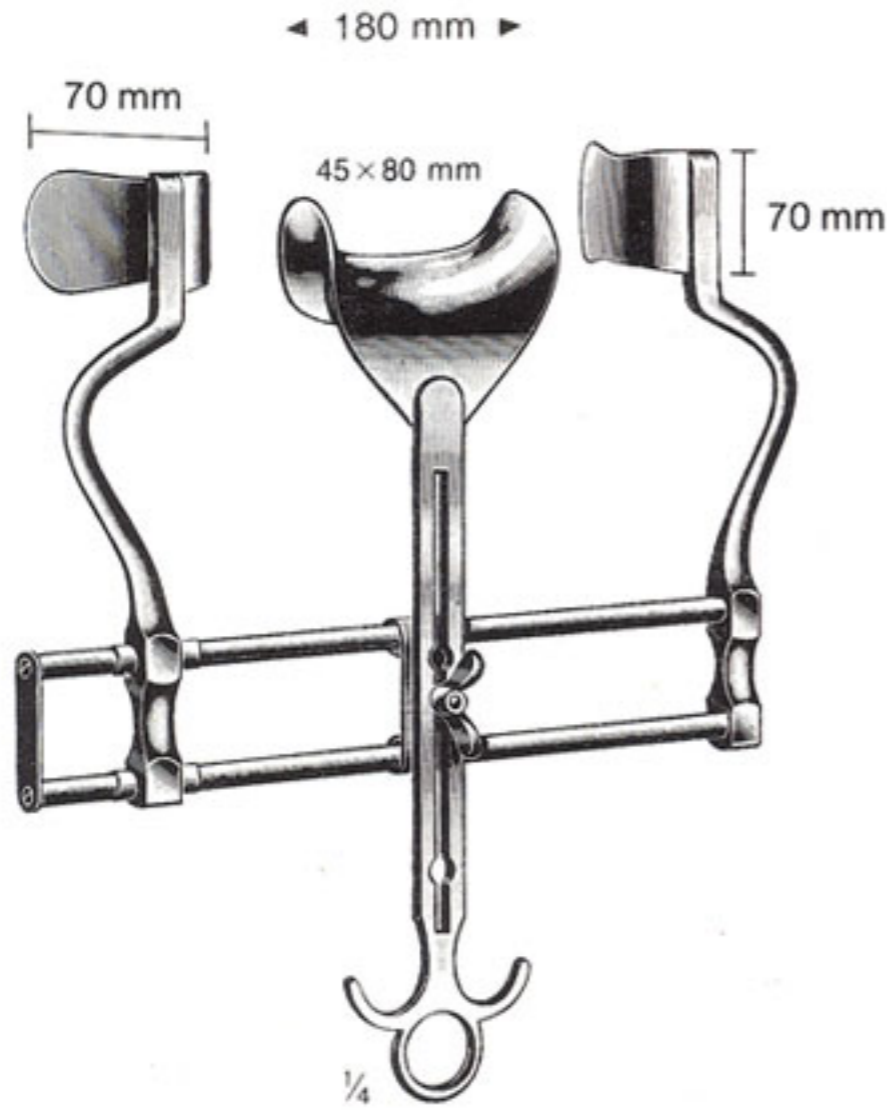

Balfour
1-854-00

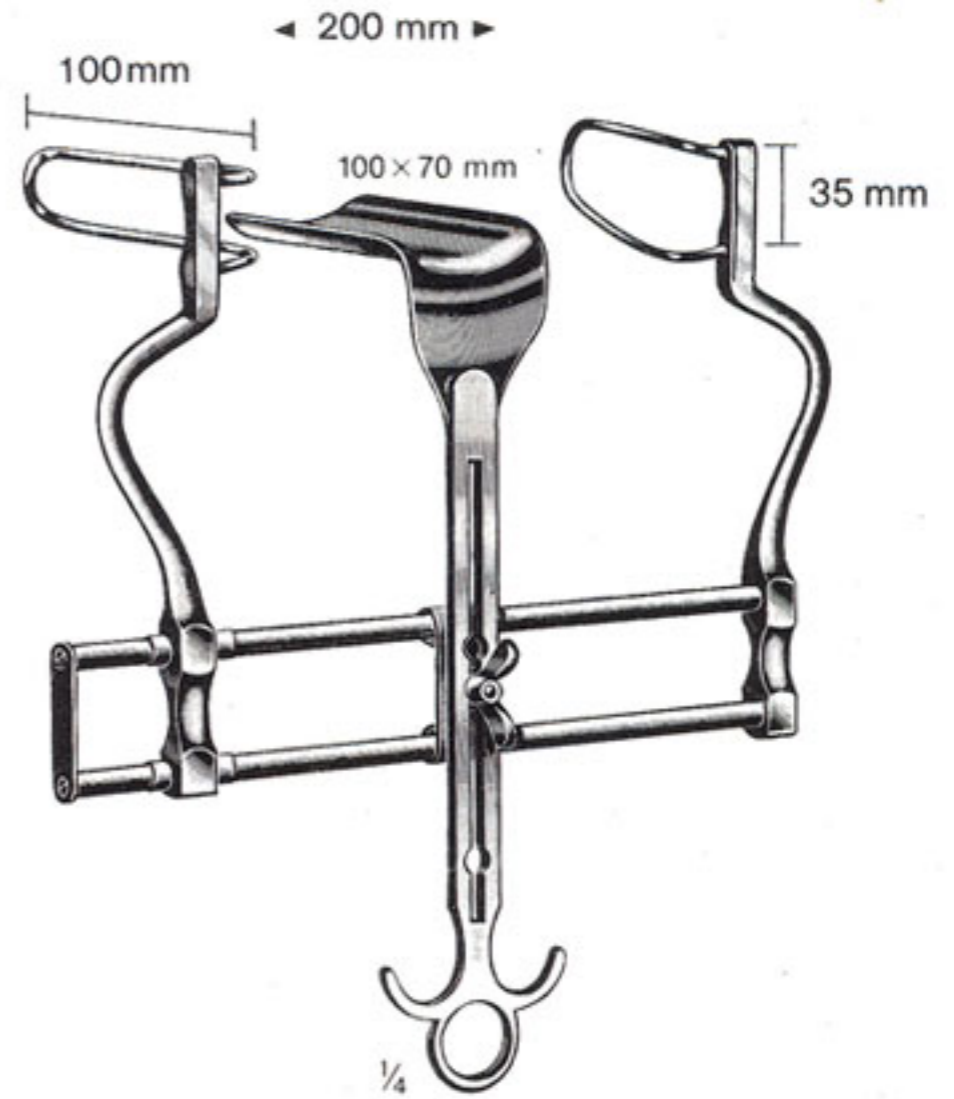

Balfour
1-856-00

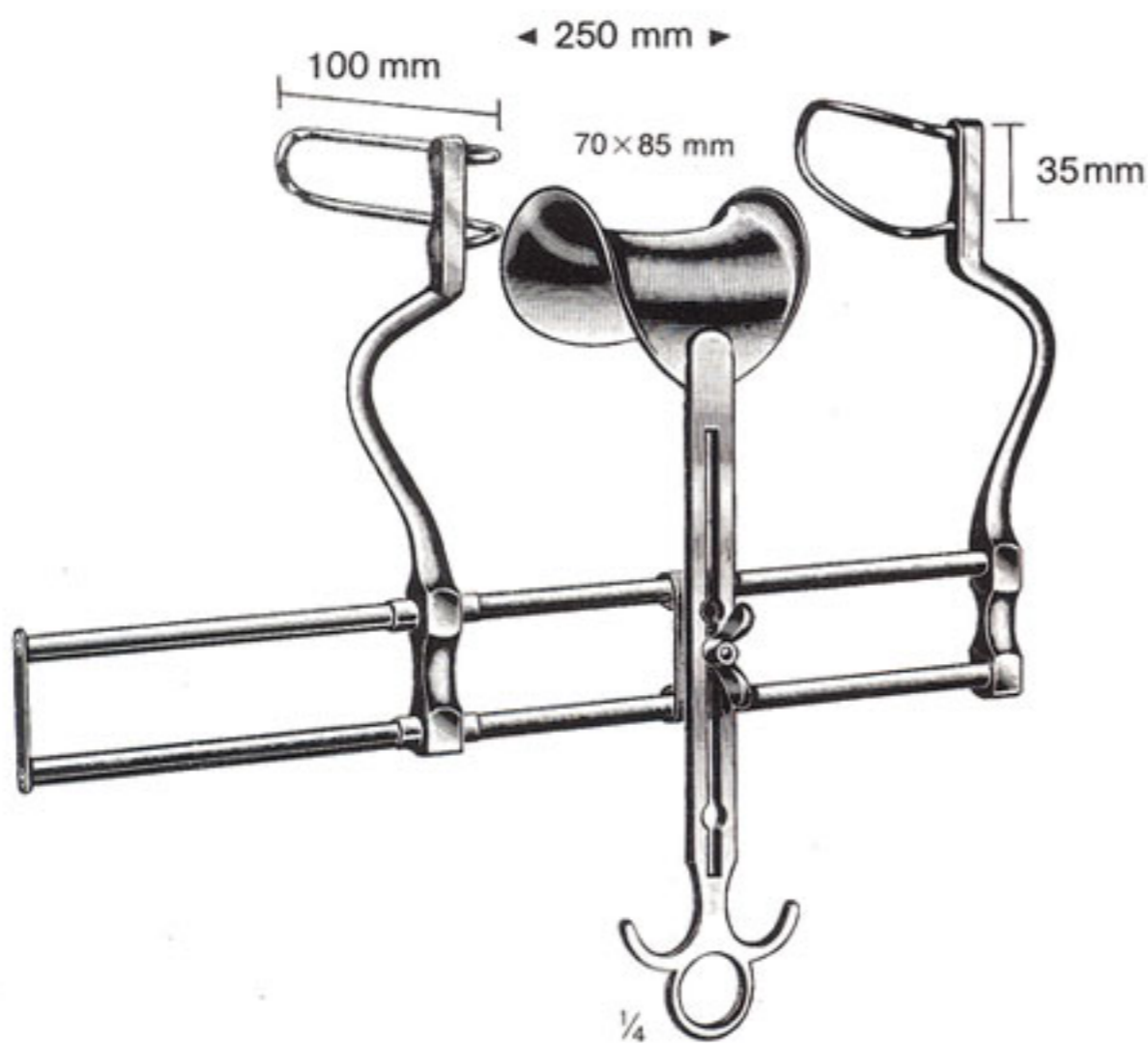

Balfour
1-858-00

Centre Blade only

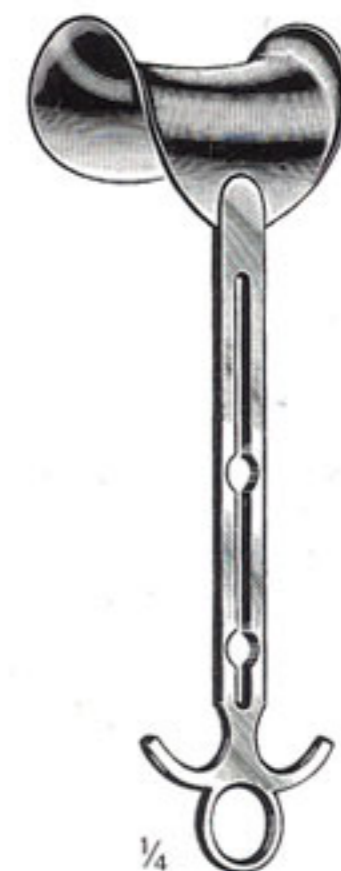

Balfour
1-859-01 = 45 x 80 mm
1-859-02 = 70 x 85 mm
1-859-03 = 80 x 90 mm