

The logo for Precision Instruments Corp features the company name in a white, sans-serif font. The text is split across two overlapping horizontal bars: an orange bar on the left and a black bar on the right. The background of the entire page is white, with a large, vibrant blue curved shape on the left side that partially overlaps the orange bar.

Precision Instruments Corp

Surgical Instruments

# INDEX

## SECTION 16: S.

Gaumen,Tonsillen - Palate,Tonsil - Paladar,Amigdalas

1. Gaumenmesser, TonsillenabszeBmesser  
Cleft Palate Knives 4 to 4 page  
Bisturies para operaciones del paladar
2. Tonsillennadeln  
Tonsil Needles 5 to 5 page  
Agujas para suturas de amigdalas
3. Tonsillennmesser, Roderbinder  
Tonsil Knives, Ligature Carrier 6 to 6 page  
Bisturies para amigdalas, Portaligaduras
4. Tonsillenelevatorien und -haken  
Tonsil Elevators and Hooks 7 to 7 page  
Elevadores y Ganchos para amigdalas
5. Tonsillenzangen  
Tonsil Seizing Forceps 8 to 8 page  
Pinzas para coger las amigdalas
6. Tonsillen-Klemmzangen,-AbszeBzangen,AbszeBmesser  
Haemostatic and Abscess Forceps and Knife 9 to 9 page  
Pinzas hemostaticas,Pinzas y Lanceta para abscesos
7. Tonsillenschnurer  
Tonsil Snares 10 to 10 page  
Cierra-nudos para amigdalas
8. Tonsillotome, Tonsillenzangen, Tonsillenkompessorien  
Tonsillectomes, Tonsil Punch and Haemostatic Forceps 11 to 11 page  
Amigdalotomos, Pinzas cortantes y Compresores para amigdalas

# INDEX

## SECTION 16: S.

Gaumen,Tonsillen - Palate,Tonsil - Paladar,Amigdalas

9. Universalgriffe und Verlängerungsrohre,Broncho-Oesophagoskopiezangen  
Universal Handels and Interchangeable Tubes, Broncho-Esophagoscopy Forceps 12 to 12 page  
Mangos universales y Tubos de extension,Pinzas para bronco-esofagoscopia
10. Suswechselbare Zangenaufsätze  
Tips of Cutting and Grasping Forceps 13 to 13 page  
Pinzas intercambiables
11. Kehlkopfpolypenzangen, -deckrhalter, Tamponpinzetten  
Laryngeal polyp us and Tampon Forceps, Epiglottis Retractor 14 to 14 page  
Pinzas para polipos laringeos , Depresor para epiglotis, Pinzas para taponamientos

# Gaumenmesser, TonsillenabszeBmesser

## Cleft Palate Knives

### Bisturies para operaciones del paladar



1-106-17

Cleft Palate and Tonsil Knife,  
two-edged, with protecting cap

1-109-19- 1-117-02

Cleft Palate Knives

# Tonsillennadeln Tonsil Needles Agujas para suturas de amigdalas



1-171-24 – 1-177-22  
1-181-23

Tonsil Needles  
Tonsil and Palate Needle

1-185-20 – 1-187-20  
1-201-01 – 1-211-21  
1-217-22  
1-219-22

Tonsil Needles  
Tonsil Knives  
ditto, with toothed blade  
Tonsil Knife and Dissector with  
semi-sharp, saw-edged blade  
with facets

# Tonsillennmesser, Roderbinder Tonsil Knives, Ligature Carrier Bisturies para amigdalas, Portaligaduras



# Tonsillenelevatoren und -haken

## Tonsil Elevators and Hooks

### Elevadores y Ganchos para amigdalas

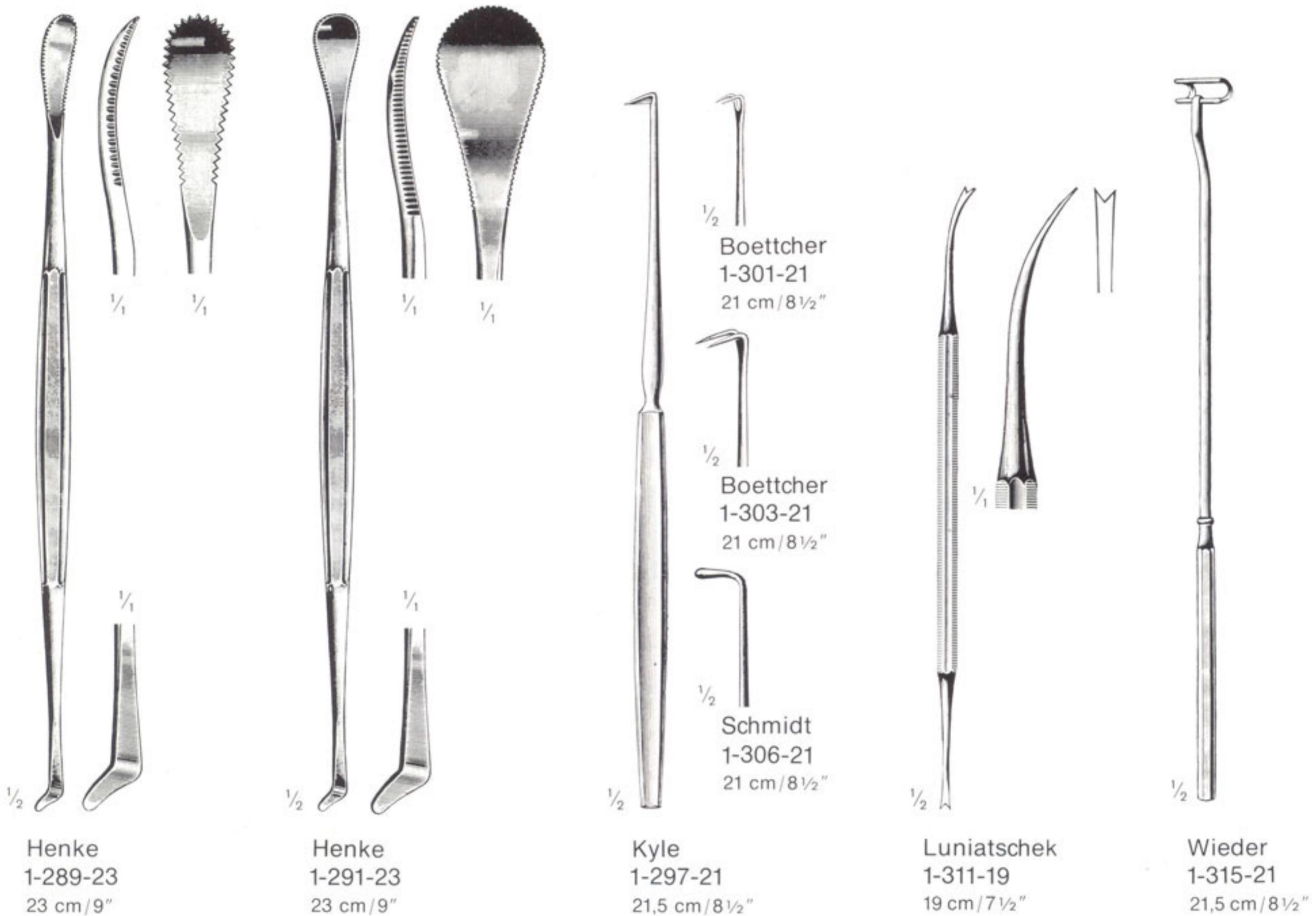

1-289-23- 1-291-23  
 1-297-21  
 1-301-21  
 1-303-21  
 1-306-21  
 1-311-19  
 1-315-21

Tonsil Elevators  
 Crypt Knife, sharp  
 Tonsil Hook, bi-pronged, sharp, small  
 ditto, large  
 ditto, blunt  
 Tonsil Gauze Packer  
 Tonsil Retractor

# Tonsillenzangen

## Tonsil Seizing Forceps

### Pinzas para coger las amígdalas

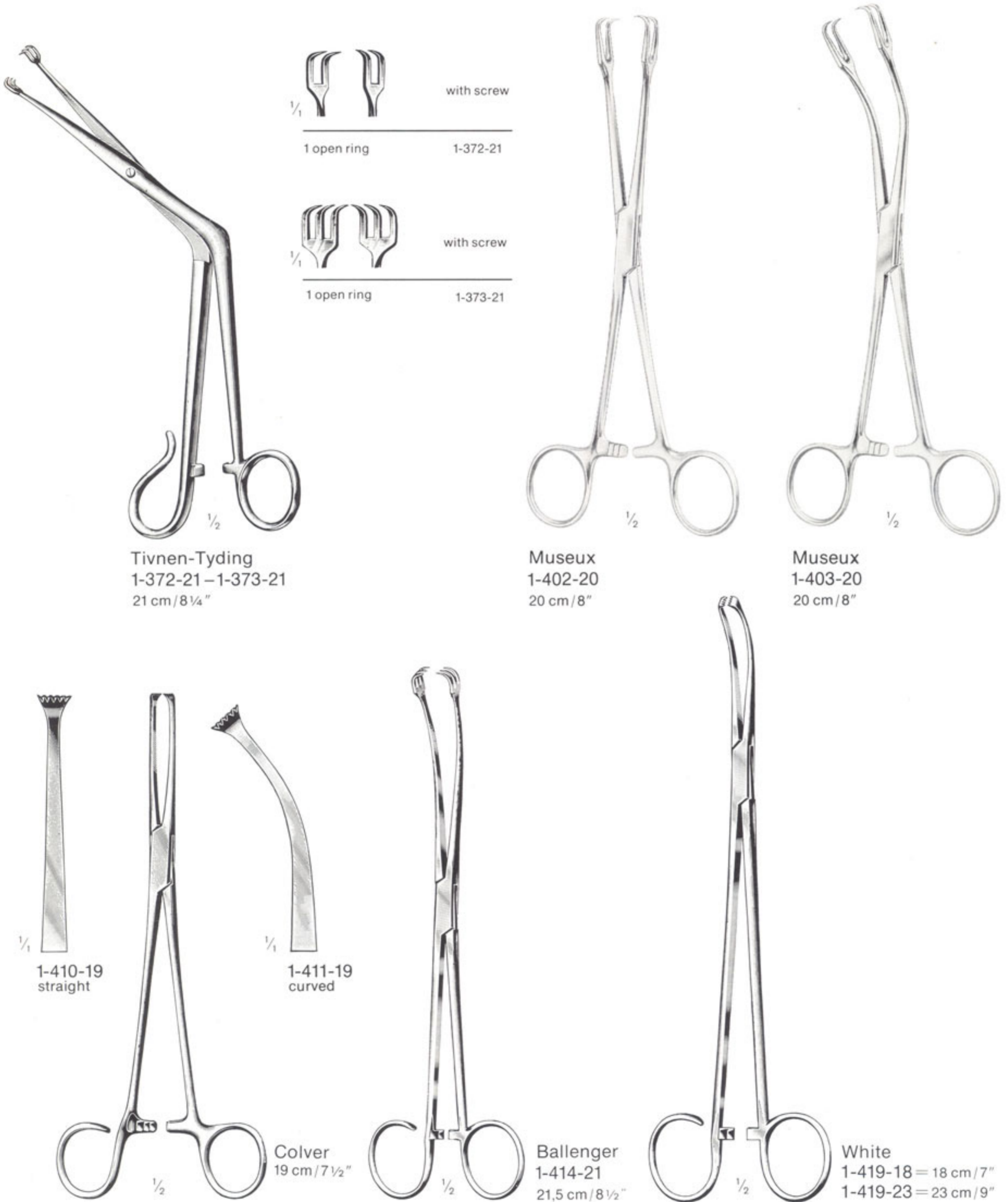

Tivnen-Tyding  
1-372-21 – 1-373-21  
21 cm / 8 1/4"

Museux  
1-402-20  
20 cm / 8"

Museux  
1-403-20  
20 cm / 8"

1-410-19  
straight

1-411-19  
curved

Colver  
19 cm / 7 1/2"

Ballenger  
1-414-21  
21,5 cm / 8 1/2"

White  
1-419-18 = 18 cm / 7"  
1-419-23 = 23 cm / 9"



# Tonsillen-Klemmzangen,-Abszeßzangen,Abszeßmesser Haemostatic and Abscess Forceps and Knife Pinzas hemostaticas,Pinzas y Lanceta para abscesos



Blohmke  
1-423-20  
20 cm/8"



Schnidt  
19 cm/7 1/2"



Schnidt  
19 cm/7 1/2"



Thilenius  
1-463-20  
20 cm/8"



Leineweber  
1-471-20  
20 cm/8"

1-443-19 – 1-449-19  
1-463-20

1-471-20

1-443-19 – 1-449-19  
1-463-20

1-471-20

1-443-19 – 1-449-19  
1-463-20

1-471-20

Tonsil Haemostatic Forceps  
Peritonsillar Abscess Forceps, with  
horizontally arranged tips  
Peritonsillar Abscess Knife,  
forceps shape, cross-action

# Tonsillenschnurer

## Tonsil Snares

### Cierra-nudos para amigdalas

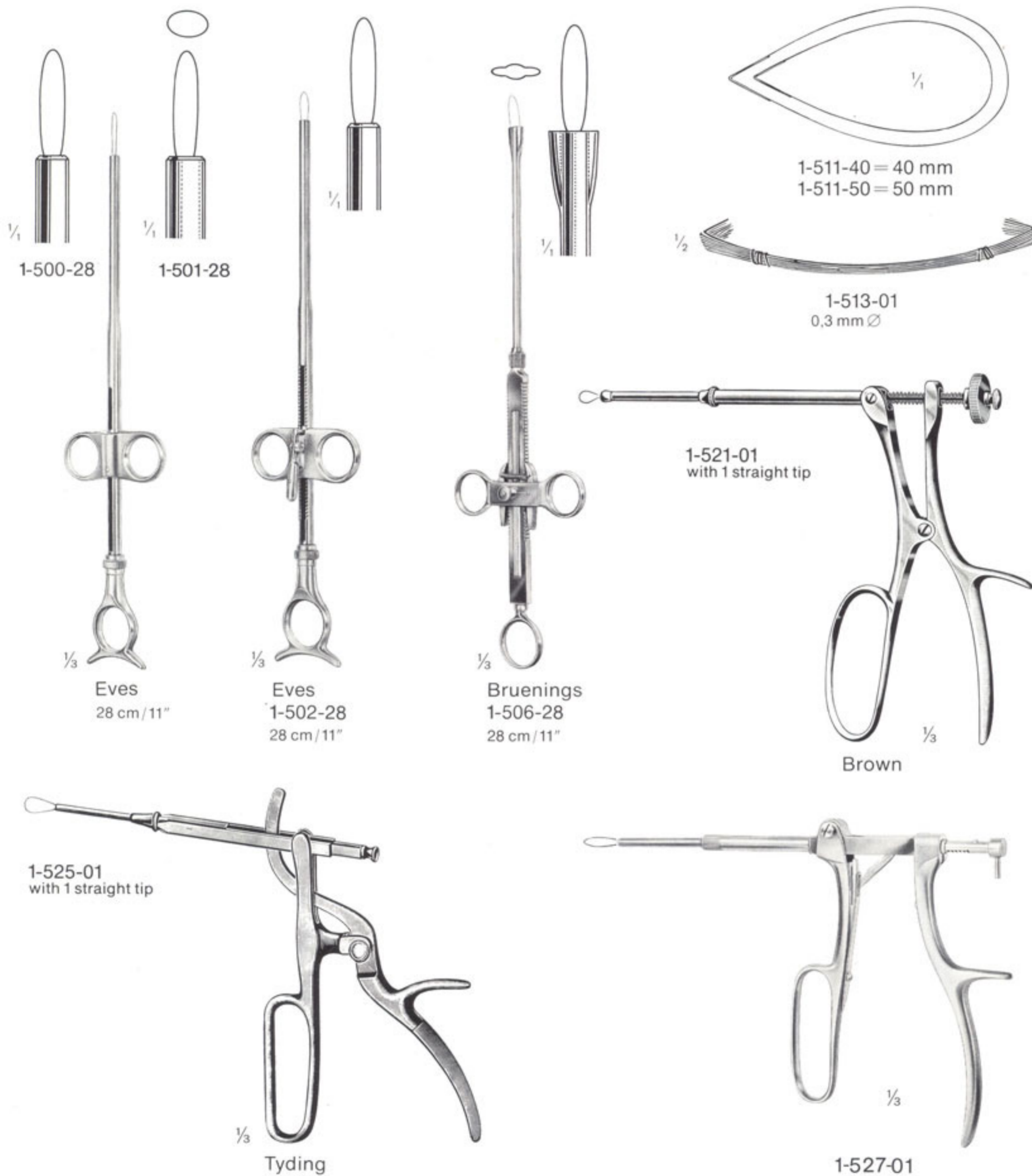

1-500-28 – 1-506-28  
 1-511-40 – 1-511-50  
 1-513-01  
 1-521-01 – 1-527-01

Tonsil Snares  
 Wire Loops only for 39-506-28  
 Snare Wires, cut and ready for use,  
 in envelopes of 1 dozen  
 Tonsil Snares

# Tonsillotome, Tonsillenzangen, Tonsillenkompessorien Tonsillectomes, Tonsil Punch and Haemostatic Forceps Amigdalotomos, Pinzas cortantes y Compresores para amigdalas

complete, with 3 tips fig. 1-3



Sluder-Ballenger  
1-531-03

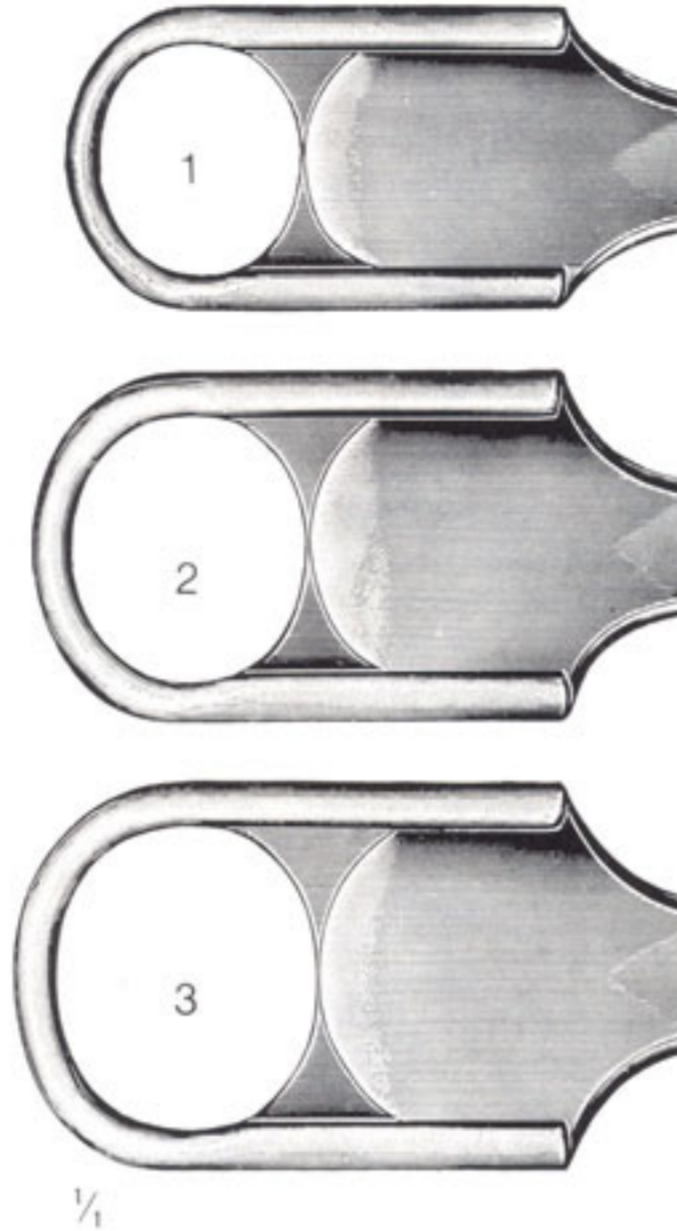

complete, with 3 tips fig. 1-3



Sluder-Ballenger  
1-535-03



Hartmann  
1-541-13 = 13 mm Ø  
1-541-15 = 15 mm Ø  
1-541-17 = 17 mm Ø

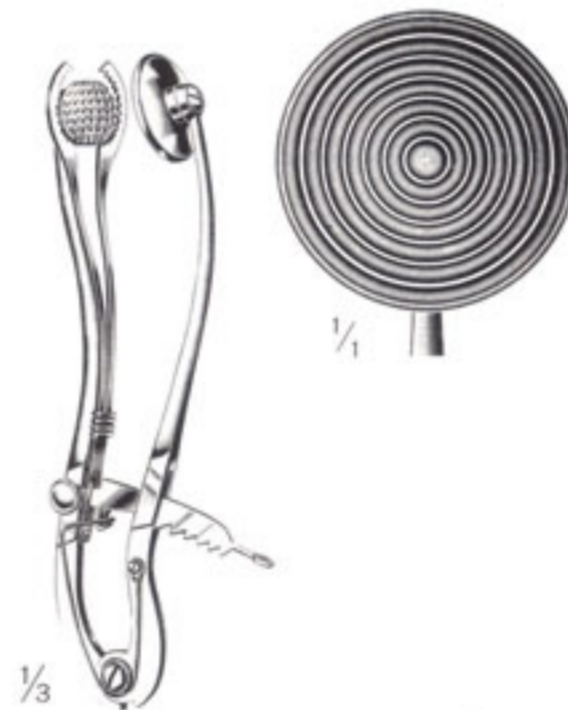

Corwin  
1-551-14  
14 cm/5 1/2"



Vetter-Ulrich  
1-555-15

1-541-13 - 1-541-17  
1-551-14, 1-555-15

Tonsil Punch Forceps, through-cutting  
Tonsil Haemostats





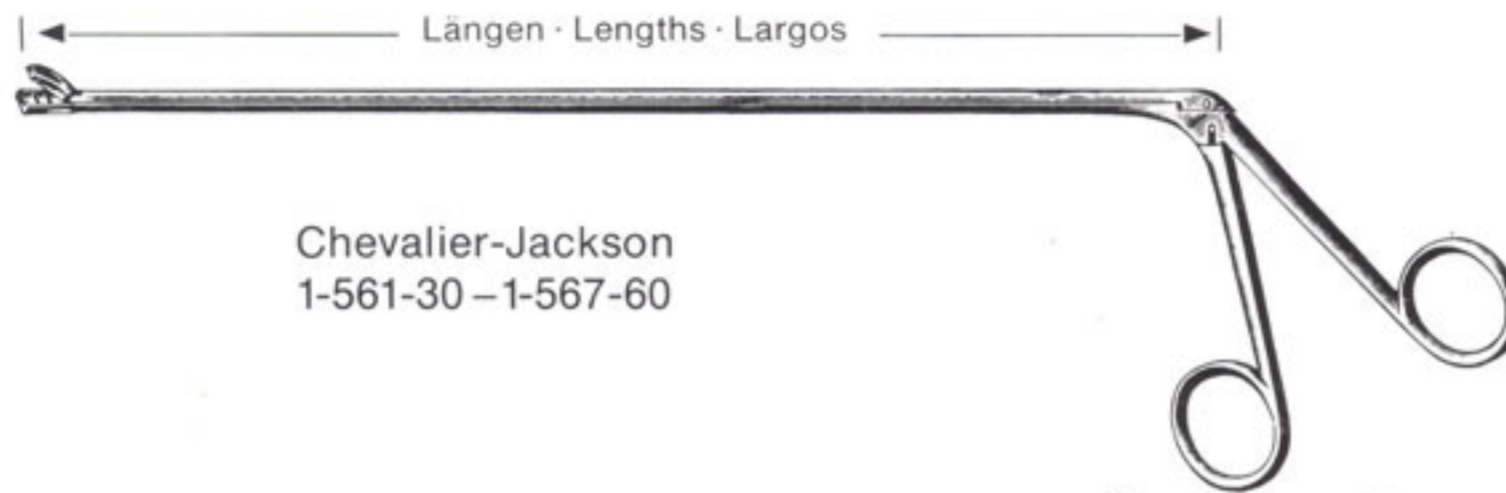

# Universalgriffe und Verlängerungsrohre, Broncho - Oesophagoskopiezangen

## Universal Handels and Interchangeable Tubes, Broncho - Esophagoscopy Forceps

### Mangos universales y Tubos de extension, Pinzas para bronco-esofagoscopia



Chevalier-Jackson  
1-561-30 – 1-567-60

lengths cm	in.	$\frac{1}{2}$							
30	12		1-561-30	1-562-30	1-563-30	1-564-30	1-565-30	1-566-30	1-567-30
40	16		1-561-40	1-562-40	1-563-40	1-564-40	1-565-40	1-566-40	1-567-40
50	20		1-561-50	1-562-50	1-563-50	1-564-50	1-565-50	1-566-50	1-567-50
60	24		1-561-60	1-562-60	1-563-60	1-564-60	1-565-60	1-566-60	1-567-60

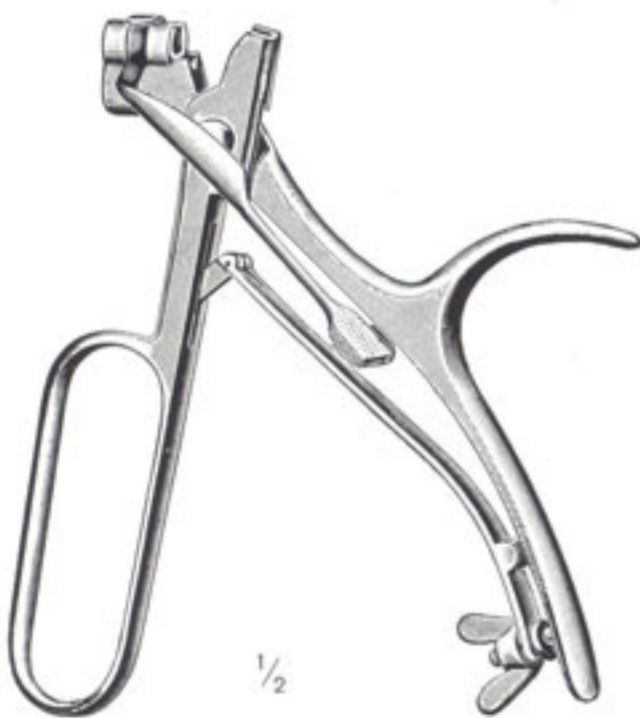

Huber  
1-581-01



Bruenings  
1-583-01



1-584-20 – 1-584-60

straight lengths angular

	cm	in.	
1-584-20	20	8	1-585-20
1-584-30	30	12	1-585-30
1-584-40	40	16	1-585-40
1-584-50	50	20	1-585-50
1-584-60	60	24	1-585-60



Bruenings  
1-587-20  
20 cm/8"

1-561-30 – 1-567-60  
1-581-01, 1-583-01

1-587-20

upper jaws movable  
Universal Detachable Handles, for  
use with interchangeable tips and  
tubes  
Laryngeal Tube for above mentioned  
handle

# Suswechselbare Zangenaufsätze

## Tips of Cutting and Grasping Forceps

### Pinzas intercambiables

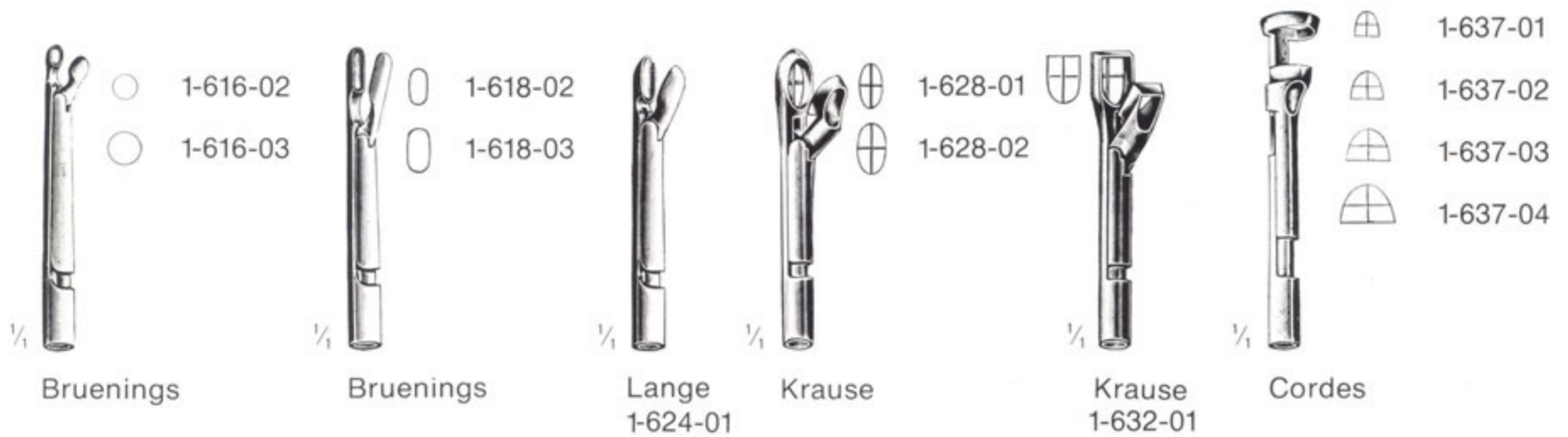

mit ziehendem Schnitt  
with drawing cut  
con corte de retroacción

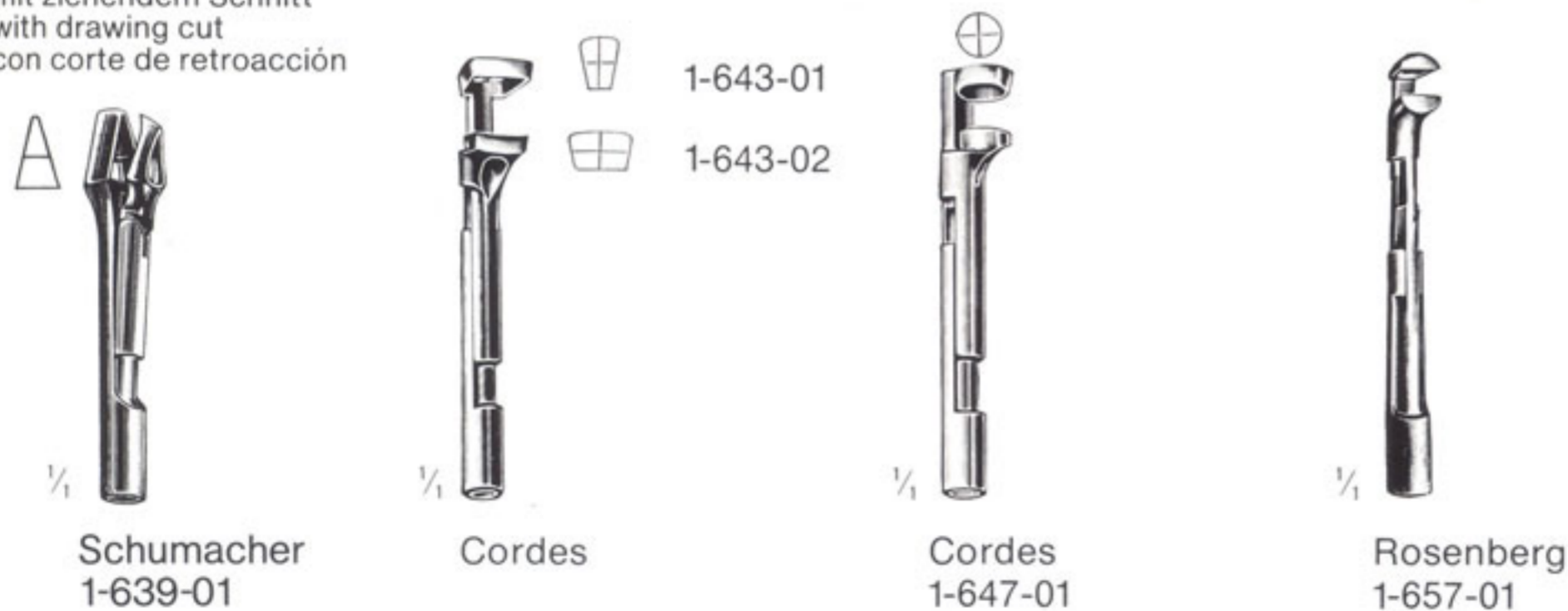

1-600-01 – 1-657-01

Aufsätze für Kehlkopf- und Speiseröhrenzangen, aufschraubbar, oberes Maulteil beweglich, passend für die Verlängerungsrohre 1-584-20 – 1-587-20 und Universalgriffe 1-581-01 bzw. 1-583-01

– Cutting and Grasping Forceps Tips, for bronchial, laryngeal and esophageal work etc., to be screwed-on, only upper jaws movable, for use with tubes and stilettes 1-584-20 – 1-589-20 and universal handles 1-581-01 resp. 1-583-01

– Pinzas intercambiables para laringe, esófago etc., con rosca, mandíbula superior móvil solamente, para usarse con los tubos de extensión 1-584-20 – 1-589-20 y los mangos universales 1-581-01 resp. 1-583-01

Kehlkopfpolypenzangen, -deckelhalter, Tamponpinzetten  
 Laryngeal polyp us and Tampon Forceps, Epiglottis Retractor  
 Pinzas para polipos laringeos , Depresor para epiglotis, Pinzas  
 para taponamientos

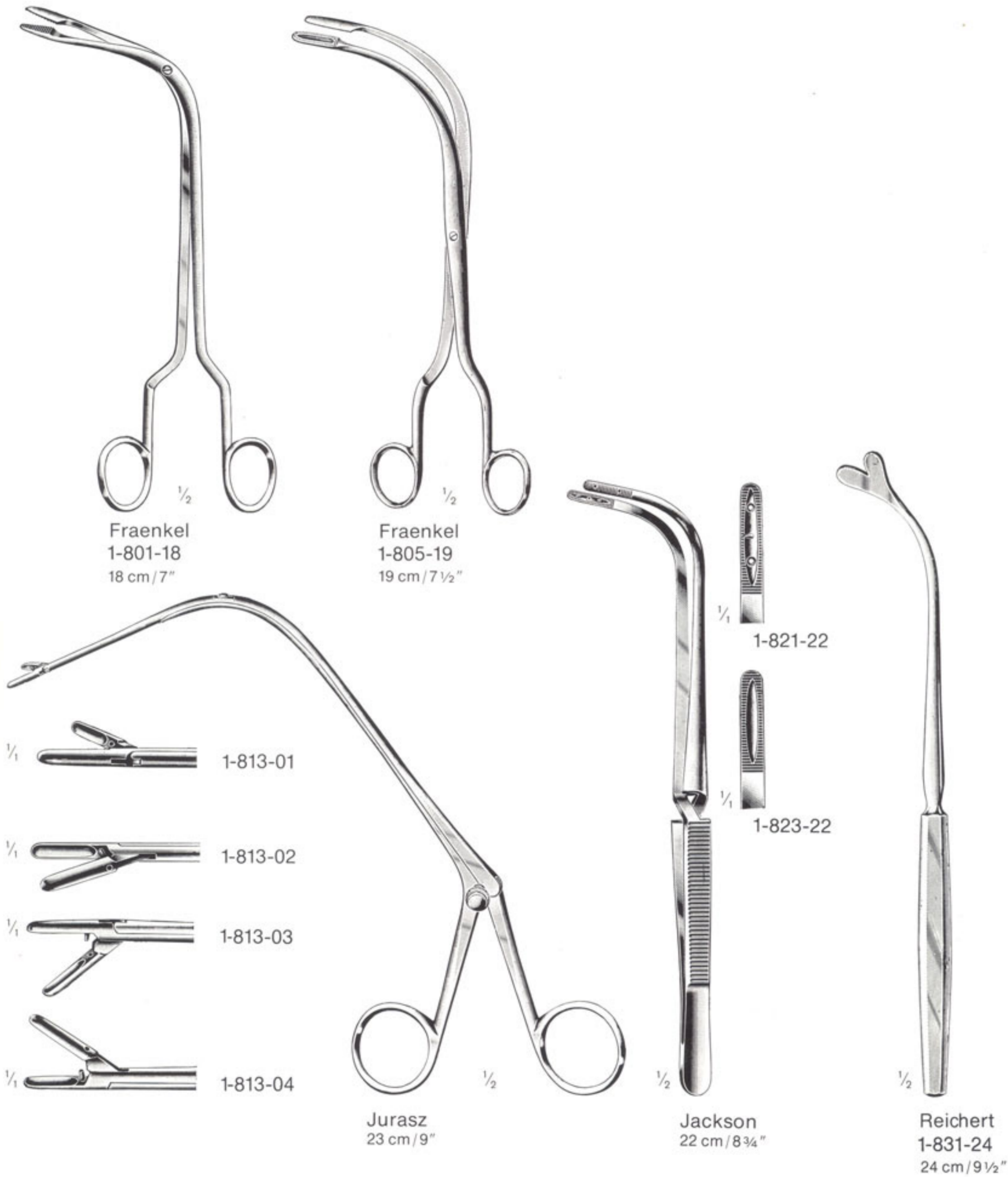

1-801-18 – 1-805-19  
 1-813-01 – 1-813-04  
 1-821-22 – 1-823-22  
 1-831-24

Kehlkopfpolypenzangen  
 Kehlkopfpolypenzangen  
 Tamponpinzetten gekreuzt  
 Kehldeckelhalter

– Laryngeal Polypus Forceps  
 – Laryngeal Polypus Forceps  
 – Applicator (Tampon) Forceps,  
 cross-action  
 – Epiglottis Retractor

– Pinzas para pólipos laringeos  
 – Pinzas para pólipos laringeos  
 – Pinzas para taponamientos,  
 automáticas  
 – Depresor para epiglotis