

The logo for Precision Instruments Corp features the company name in a bold, sans-serif font. The text is split across two overlapping horizontal bars: an orange bar on the left and a black bar on the right. The background of the entire page is white, with a large, vibrant blue curved shape on the left side that partially overlaps the orange bar.

Precision Instruments Corp

Surgical Instruments

INDEX

Section7: Cardiovascular-Chirurgie - Cardiovascular Surgery

1.	Knochen-und Rippenscheren Bone and Rib shears Cizallas para huesos y costillas	4	to	5 Pages
2.	Rippensperrer Rib Spreaders Separadores costales	6	to	8 Pages
3.	Bronchusklemmen Bronchus clamps Pinzas-clamps para bronquios	9	to	9 page
4.	GefaBklemmen Blood vessel clamps Clamps para vasos	10	to	11Pages
5.	Pulmonalis-und Aortaklemmen Pulmonic stenosis and Aorta clamps Pinzas-Clamps para pulmon y aorta	12	to	12 page
6.	Atrauma-Pinzetten mit De Bakey-Zahnung Atrauma Forcep With De Bakey Toothing Pinzas Atrauma con dentado De Bakey	13	to	13 page
7.	Atrauma-Bulldogklemmen Atrauma Bulldog Clamps Clamps Bulldog Atrauma	14	to	15 Pages
8.	Atrauma-GefaBklemmen mit De Bakey-Zahnung Atrauma Blood Vessel Forceps Atruma Pinzas para vasos con	16	to	28 Pages

INDEX

Section7: Cardiovascular-Chirurgie - Cardiovascular Surgery

9. Atrauma-GefaBklemmen
Atrauma Artery Forcep and clamps 29 to 31 Pages
Pinzas Clamps Atrauma
10. Instrumente fur Hirnnaht
Instruments For Brain suture 32 to 32 page
Instrumentos para sutura cerebral
11. Dura Dissektoren, Nervseparatoren
Dura Dissectors, Nerve Separators 33 to 33 page
Disecacores para dura-madre, Descoladores de nervios
12. Bandscheibenstanzen
Intervertebral Disc Rongeurs 34 to 34 page
Pinzas cortantes para discos intervertebrales
13. Laminektomie-Zangen
Laminectomy Rongeurs 35 to 35 page
Pinzas cortantes para laminectomia

Knochen-und Rippenscheren Bone and Rib shears Cizallas para huesos y costillas



1-100-23 = 23 cm/9"
Bone Shears

1/2



1-101-22
22 cm/8 3/4"

1/2



1-104-17
17 cm / 6 3/4"

1/2



with eccentric
sliding blade

Gluck
1-107-22
22 cm/8 3/4"

1/2

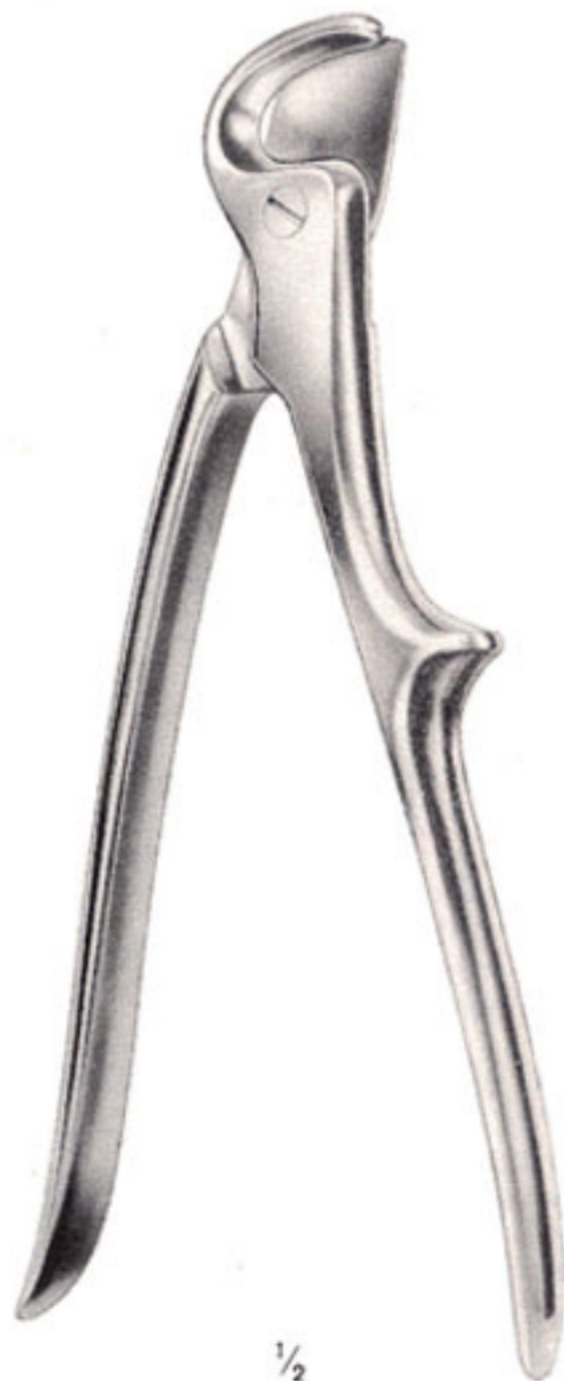

Stille
1-111-21
21 cm/8 1/4"

1/2

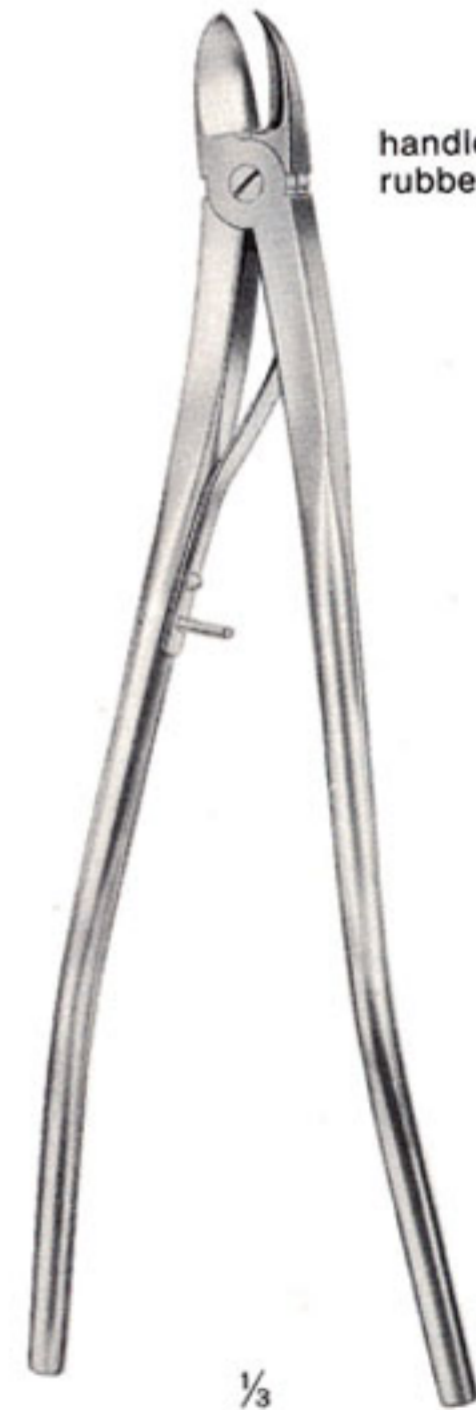

handles with
rubber cover

Bethune
1-126-34
34 cm/13 1/2"

1/3

Knochen-und Rippenscheren Bone and Rib shears Cizallas para huesos y costillas



Sauerbruch
1-131-26
26 cm/10 $\frac{1}{4}$ "



Giertz-Stille
1-137-27
27 cm/10 $\frac{1}{2}$ "



Sauerbruch-Frey
1-141-36
36 cm/14"



Lebsche
1-145-25
25 cm/10"



Brunner
1-147-28 – 1-149-28
32 cm/12 $\frac{1}{2}$ "

1-147-28
for the right hand

1-149-28
for the left hand



Lebsche
1-151-24
24,5 cm/9 $\frac{3}{4}$ "

Rippensperrer Rib Spreaders Separadores costales

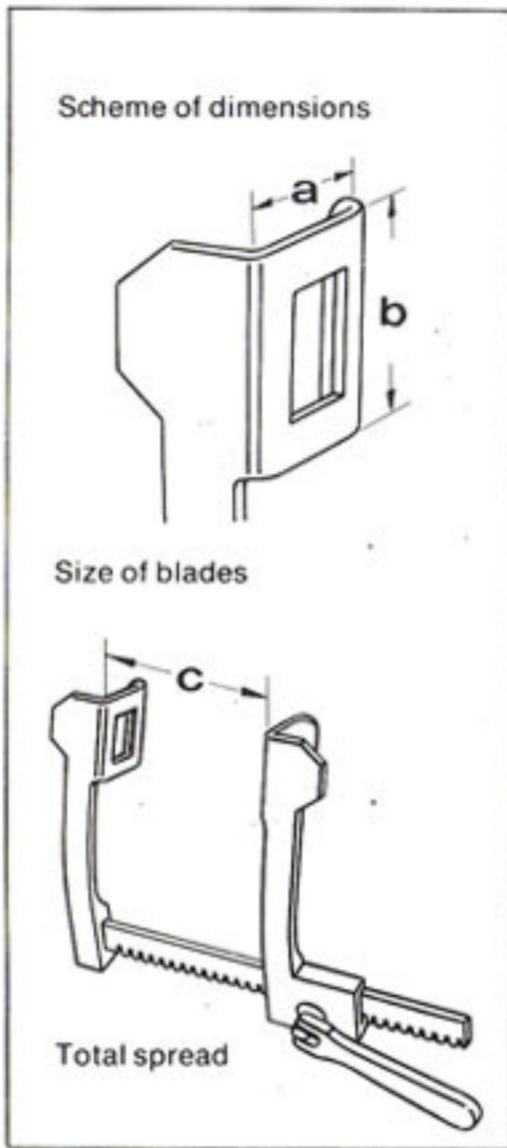

Infant

	a	b	c
1-161-01	15 mm	15 mm	75 mm

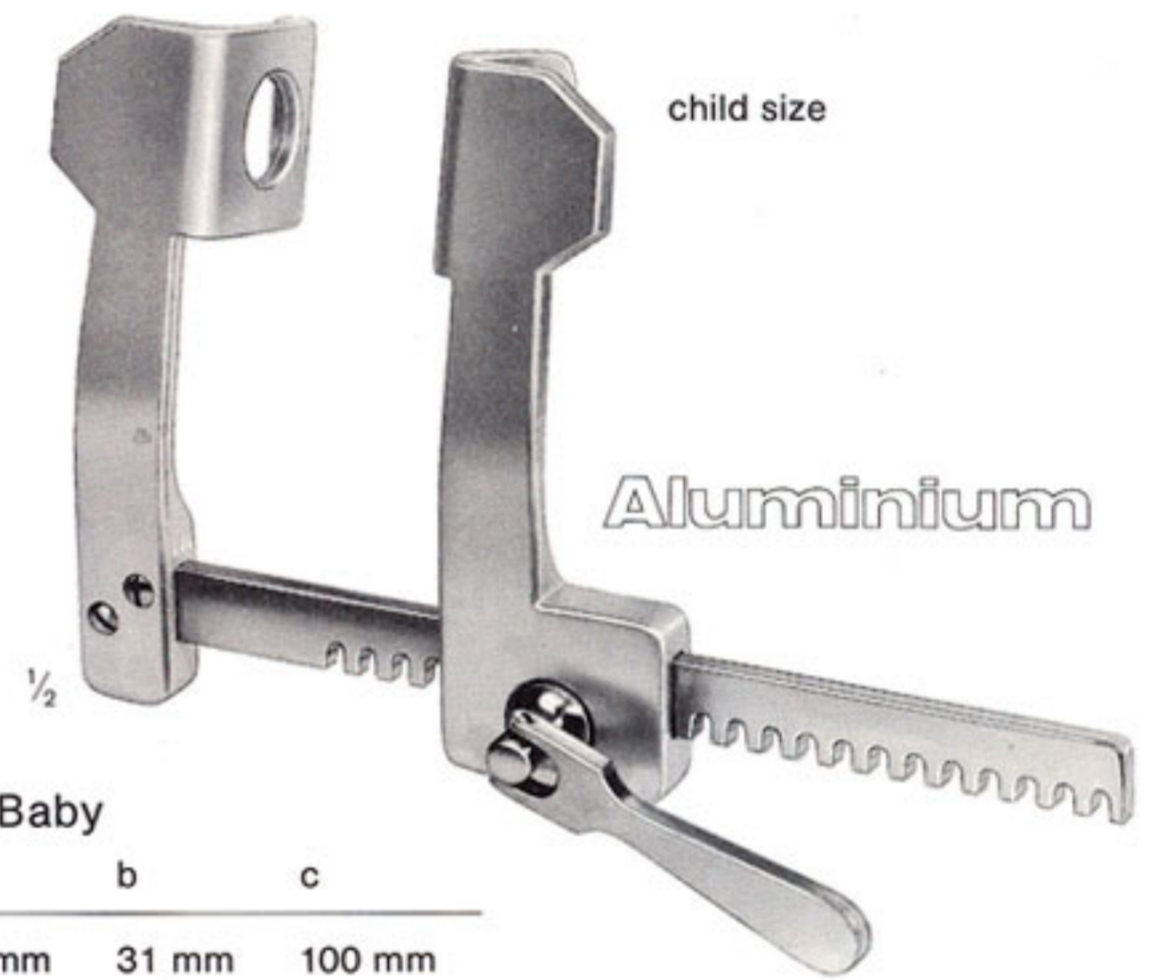

Baby

	a	b	c
1-162-01	31 mm	31 mm	100 mm

from aluminium, anodized



Finocchetto

	a	b	c
1-163-01	38 mm	44 mm	135 mm
1-163-02	52 mm	62 mm	135 mm
1-163-03	85 mm	65 mm	135 mm

Rippensperrer Rib Spreaders Separadores costales

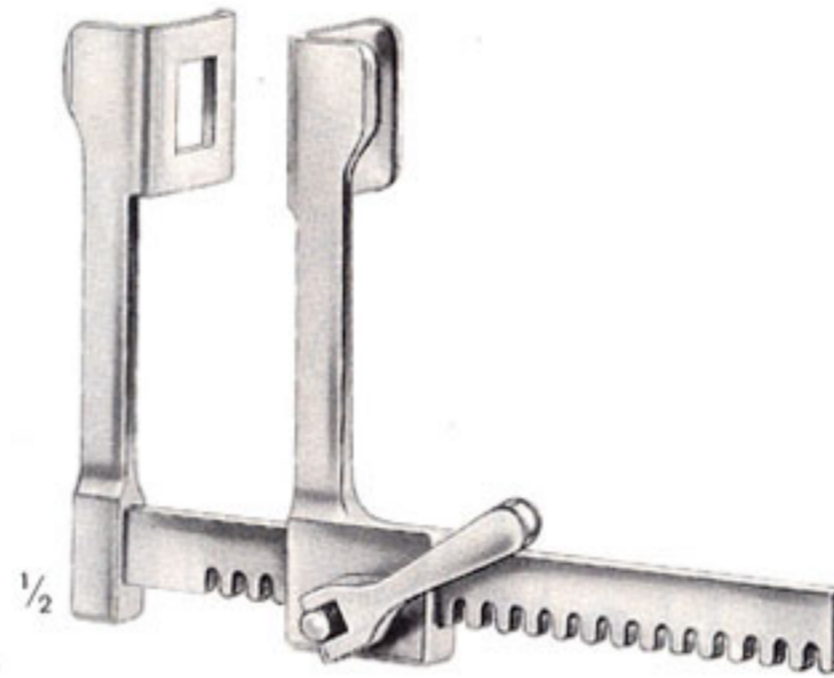
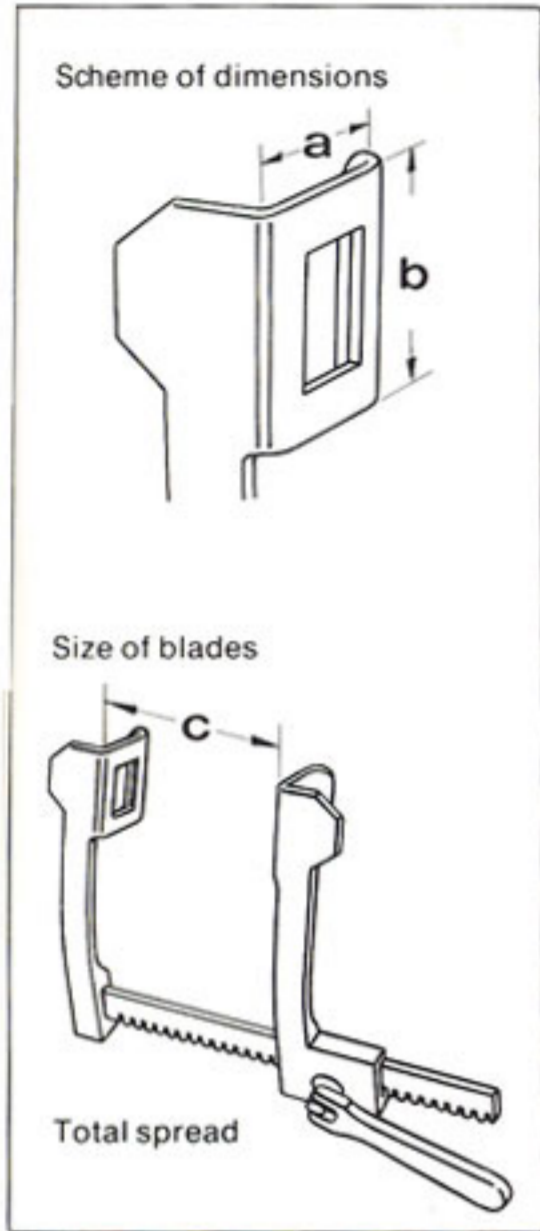

Finocchietto - Baby

	a	b	c
1-177-75	18 mm	20 mm	75 mm



Finocchietto

	a	b	c
1-178-01	40 mm	40 mm	165 mm
1-178-02	45 mm	65 mm	200 mm
1-178-03	70 mm	65 mm	250 mm

Rib and Pneumolysis Spreaders, with ratchet, self-retaining

1-178-01
1-178-02
1-178-03

small pattern
medium pattern
large pattern

Rippensperrer Rib Spreaders Separadores costales

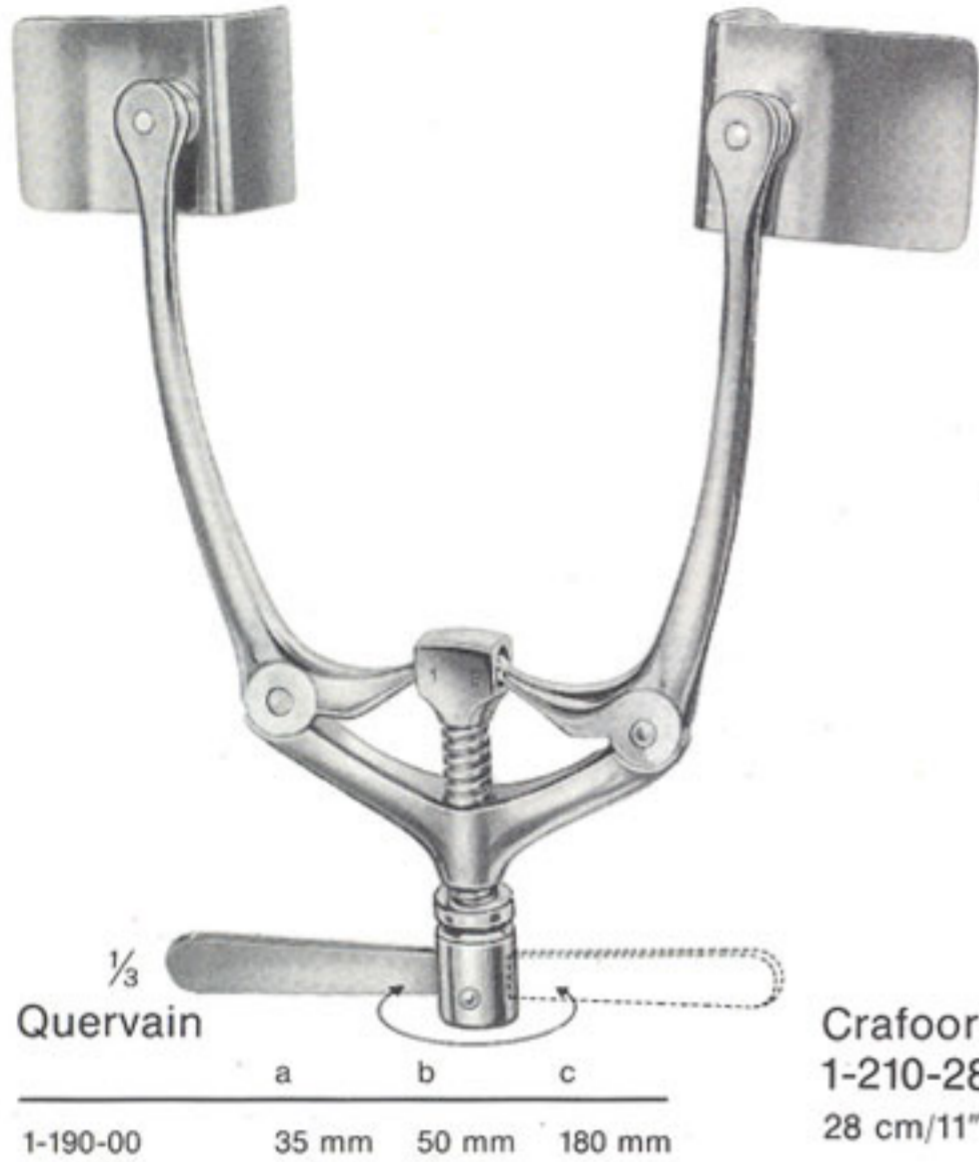

Crafoord
1-210-28
28 cm/11"



Sellers
1-218-19
19 cm/7 1/2"

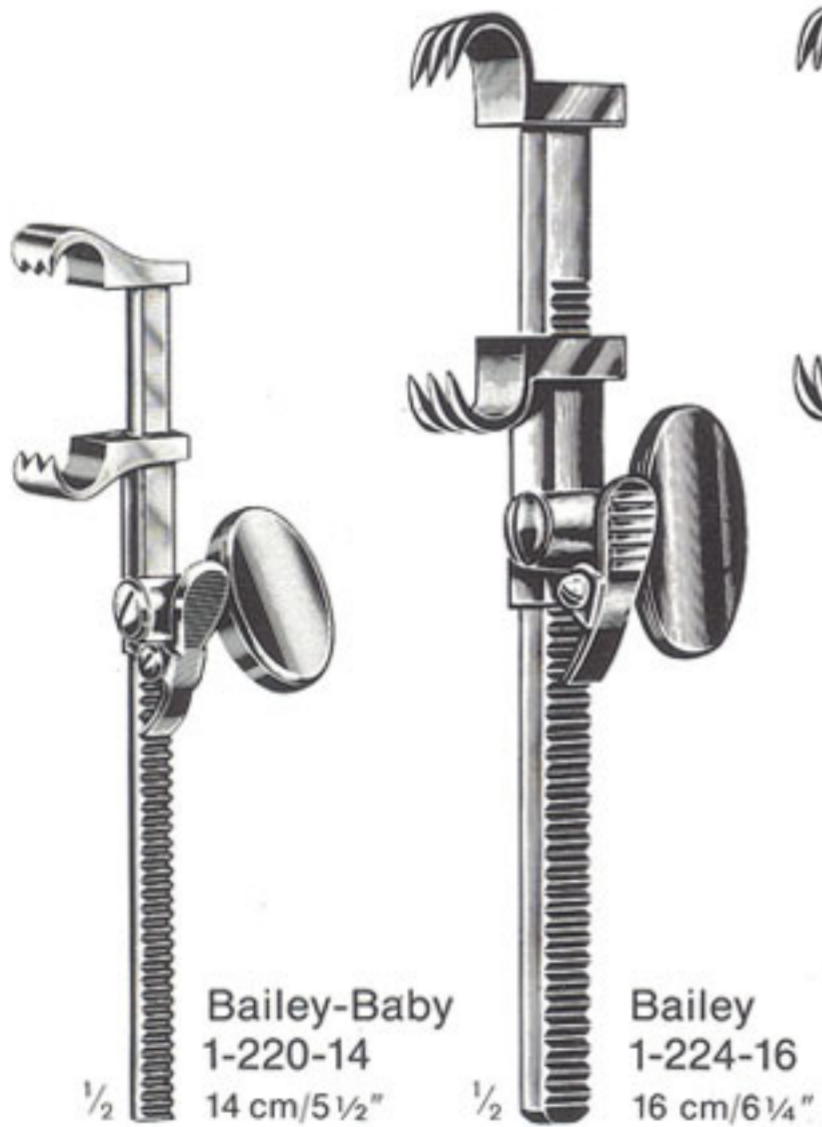

Allison
1-231-30 = 30 cm/12"
1-231-32 = 32 cm/12 1/2"



1-233-26
26 cm/10 1/4"



- 1-190-00 Rib Spreaders
- 1-210-28 Rib Contractor, with long ratchet
- 1-218-19 Rib Spreader and Approximator, with rotating pronged arms with ratchet, Baby pattern
- 1-220-14 with ratchet, Baby pattern
- 1-224-16 with short arms
- 1-226-16 with long arms
- 1-231-30 Lung Spatula for children, 45 mm (1 3/4") wide, elastic
- 1-231-32 ditto, for adults, 57 mm (2 1/4") wide, elastic
- 1-233-26 Lung Spatula, extra broad

Bronchusklemmen

Bronchus clamps

Pinzas-clamps para bronquios



Price-Thomas
1-241-22
22 cm/8 3/4"

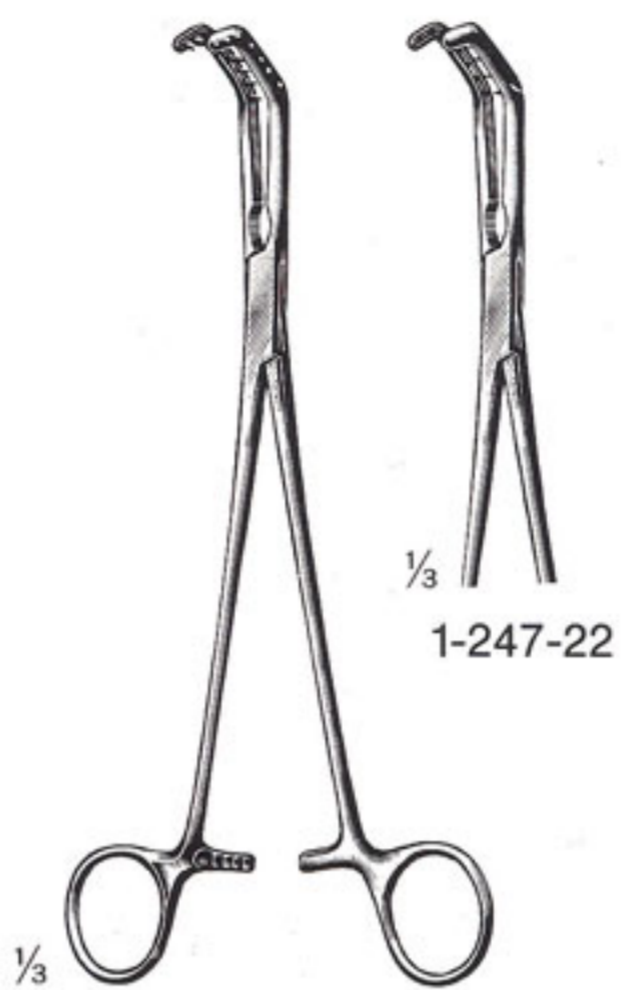

Price-Thomas
1-245-22
22 cm/8 3/4"



Sarot
1-251-23 - 1-257-23
23 cm/9"



Semb
1-265-24 - 1-267-24
24 cm/9 1/2"

Gefaßklemmen

Blood vessel clamps

Clamps para vasos

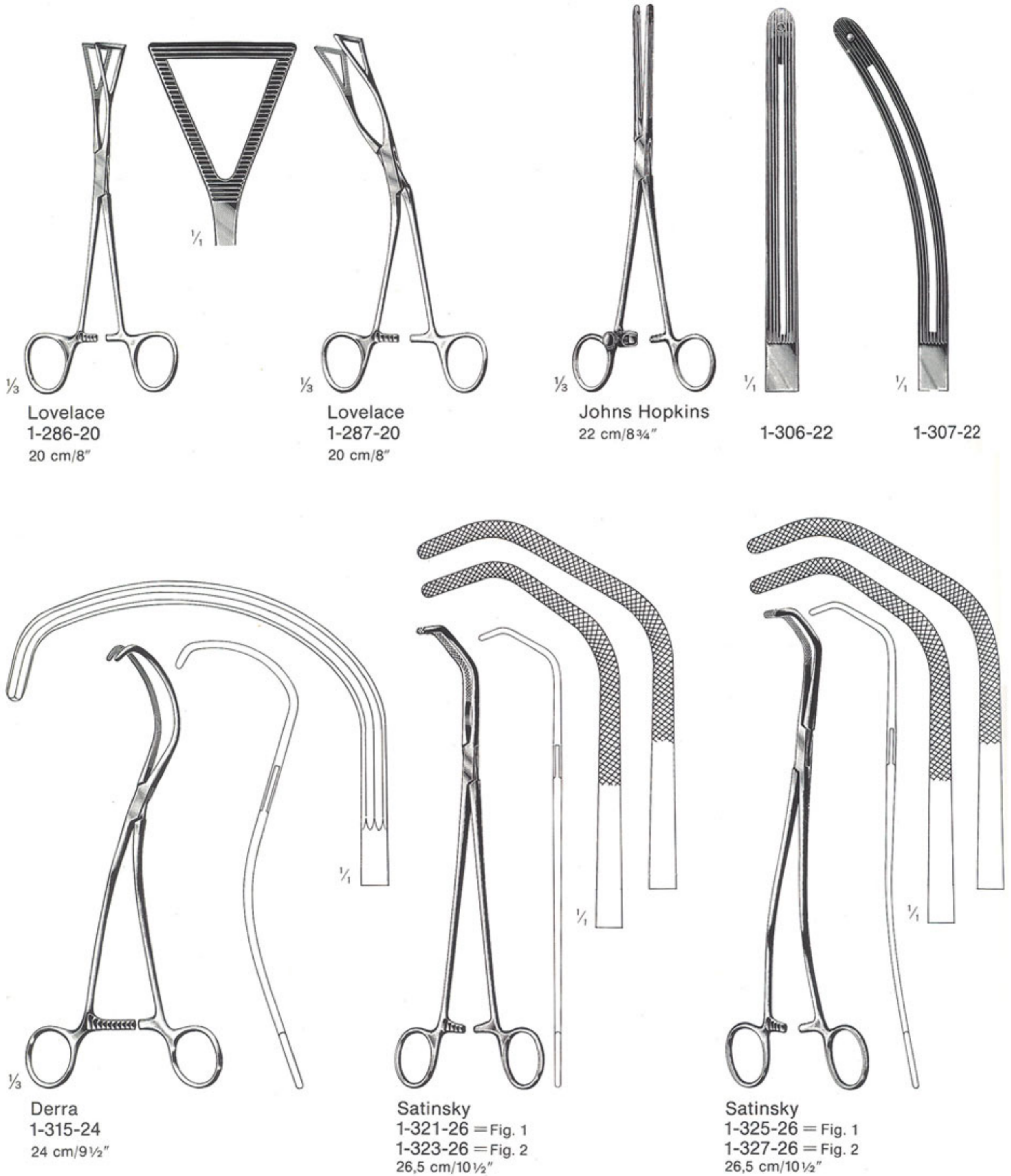

Gefaßklemmen

Blood vessel clamps

Clamps para vasos

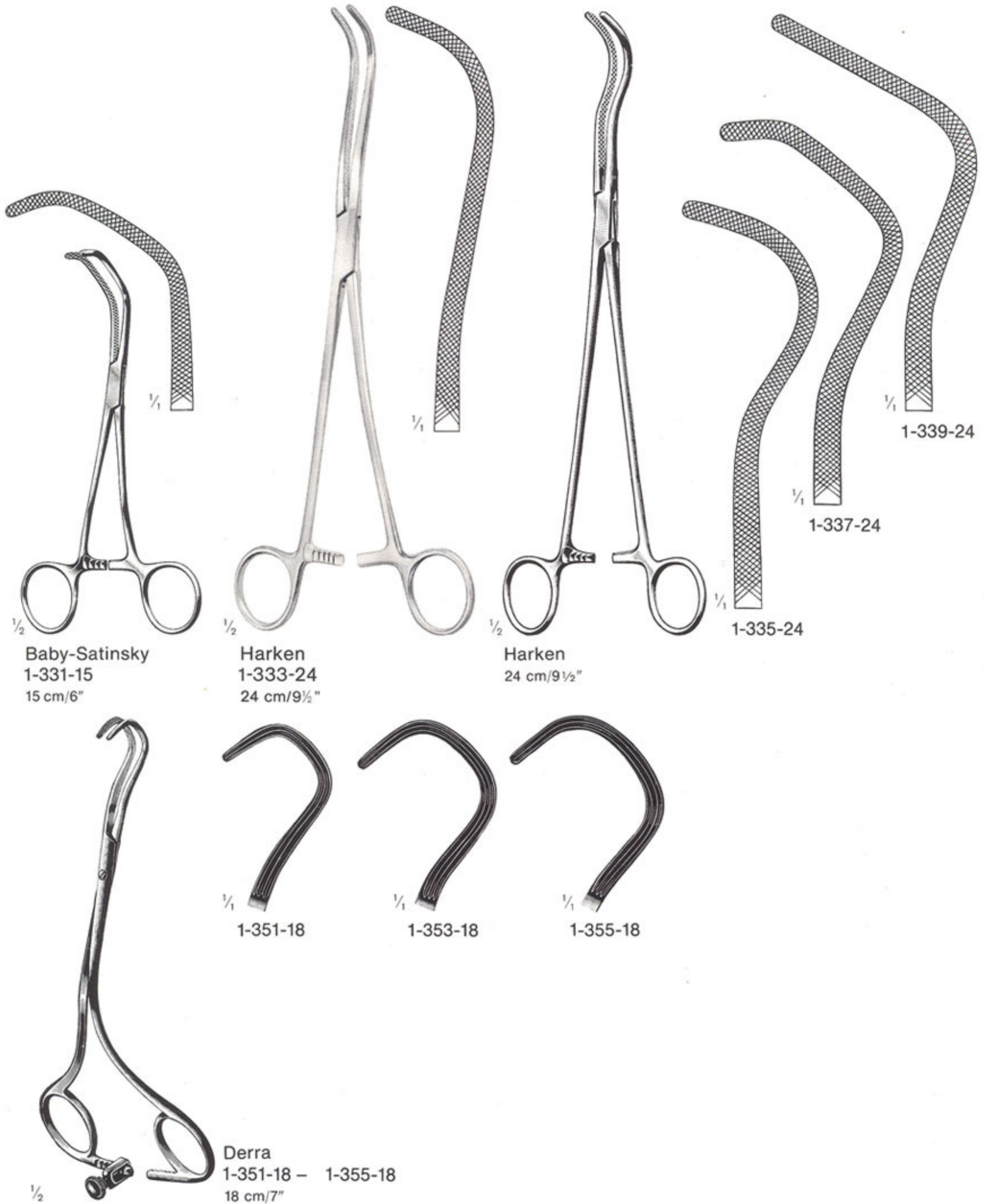

Pulmonalis-und Aortaklemmen

Pulmonic stenosis and Aorta clamps

Pinzas-Clamps para pulmon y aorta

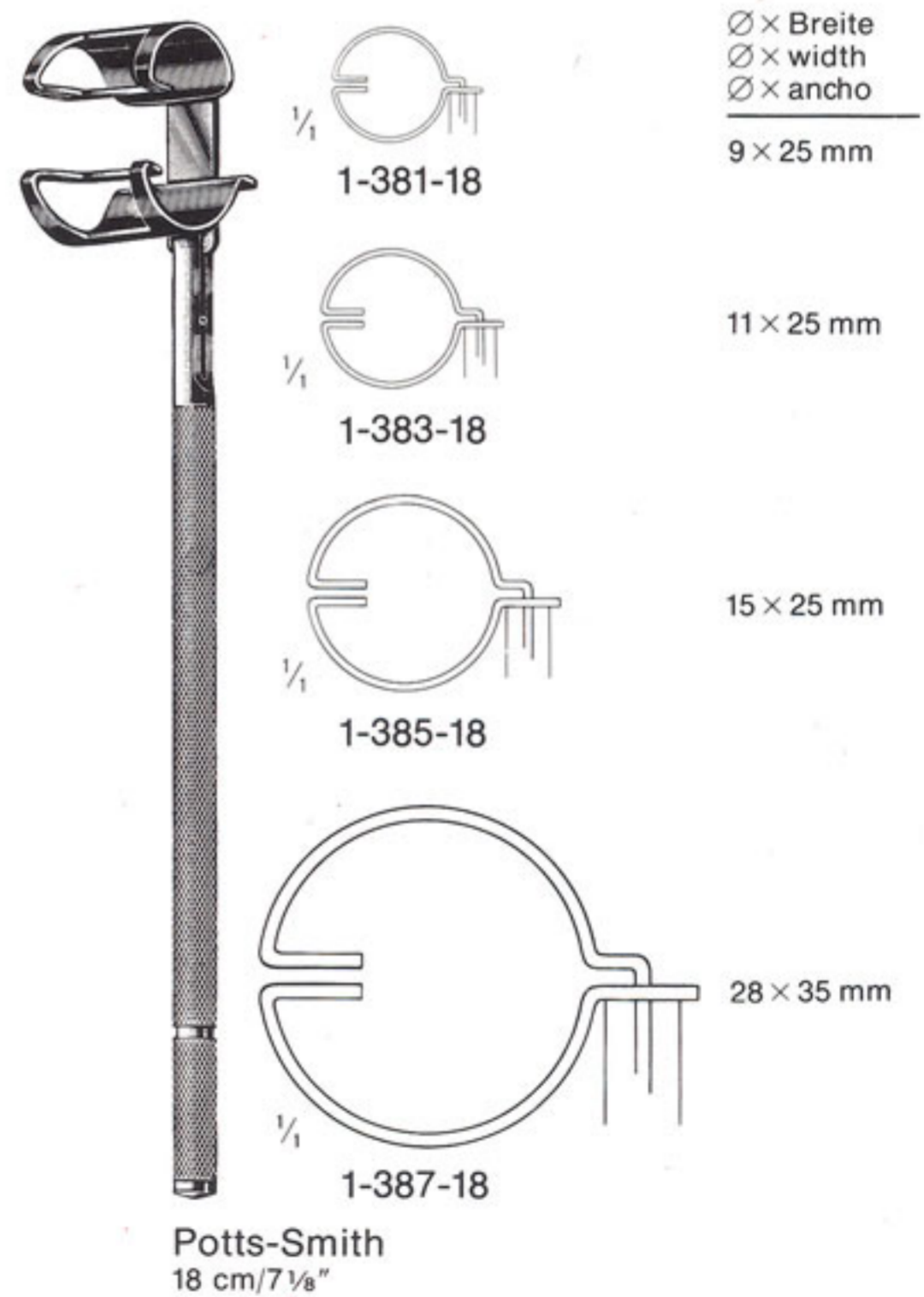
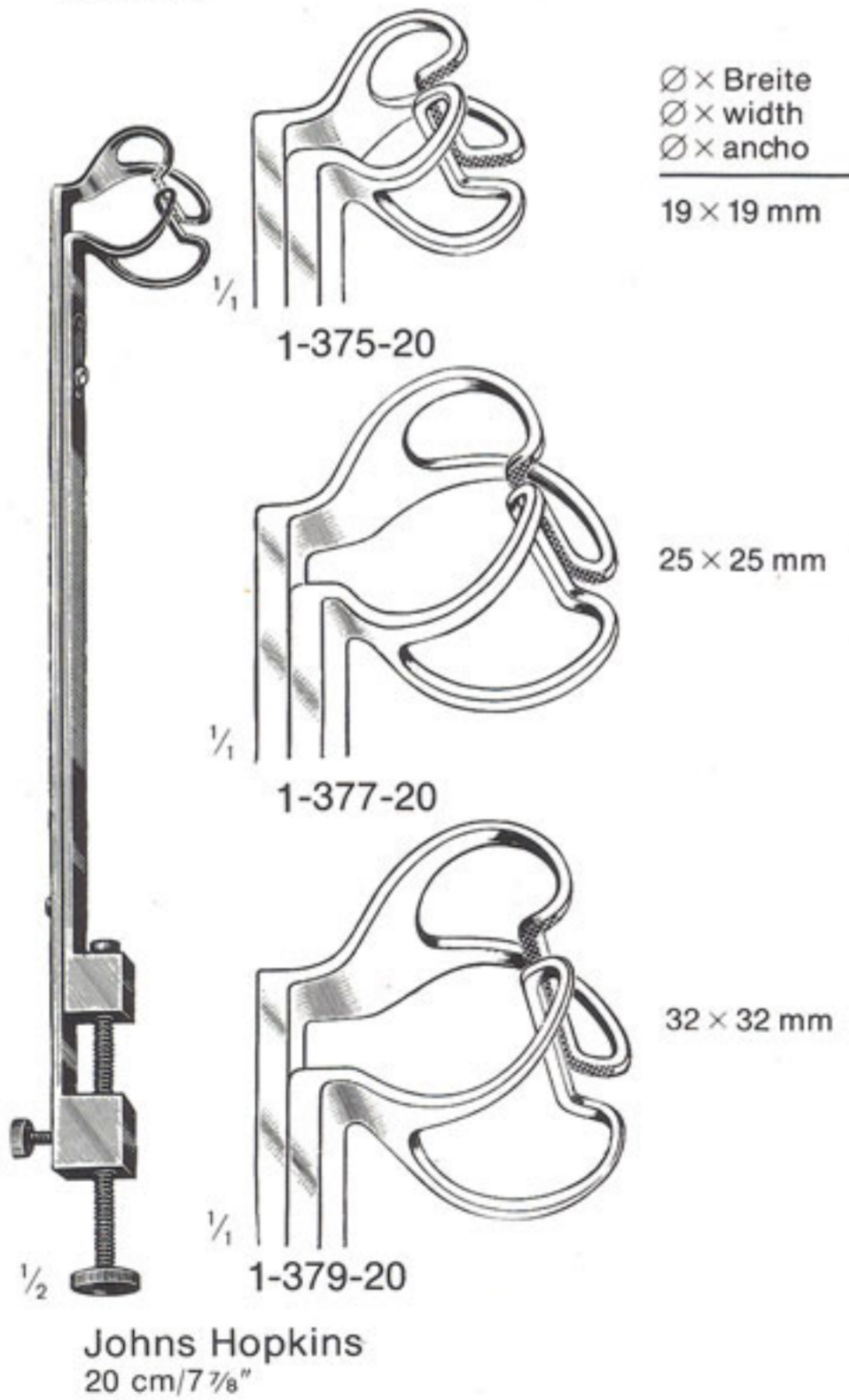
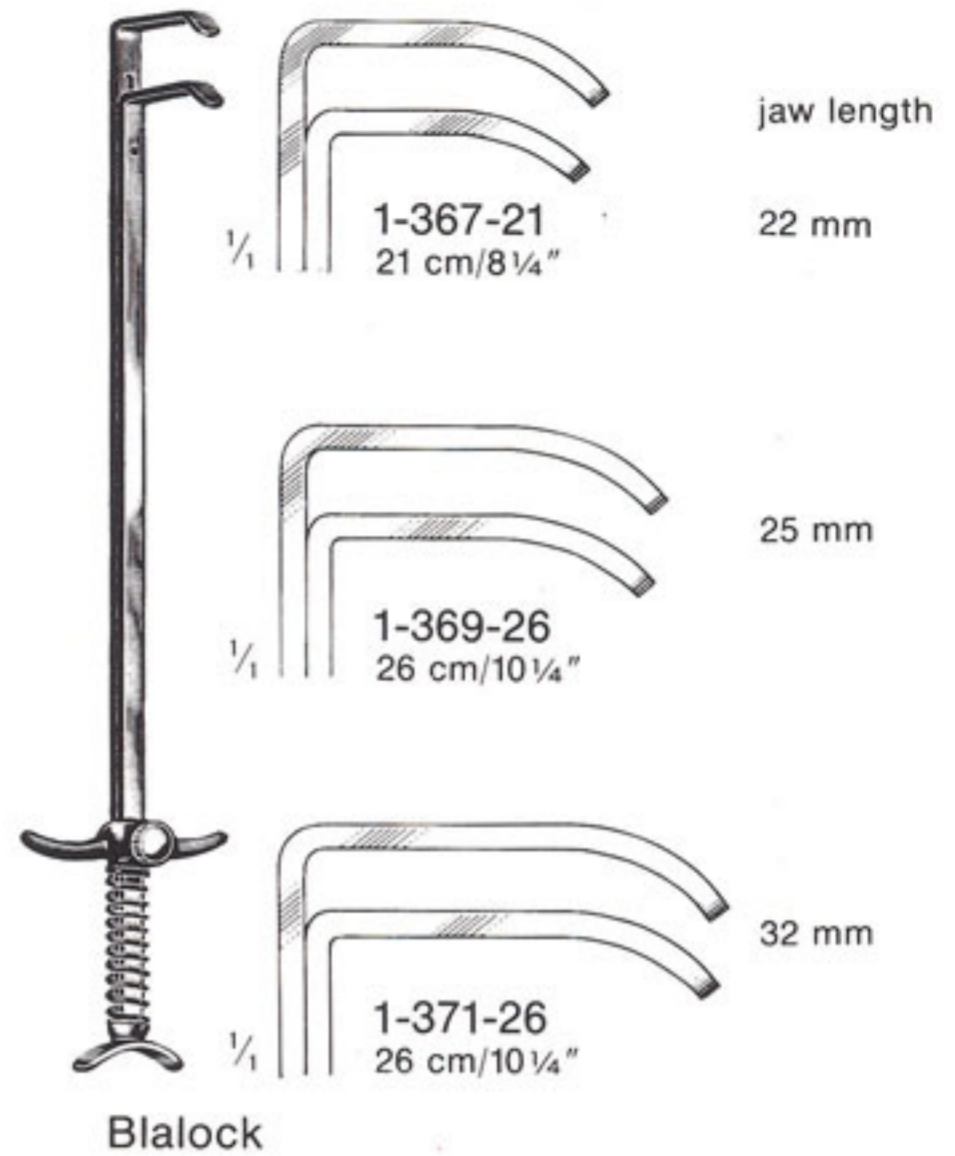
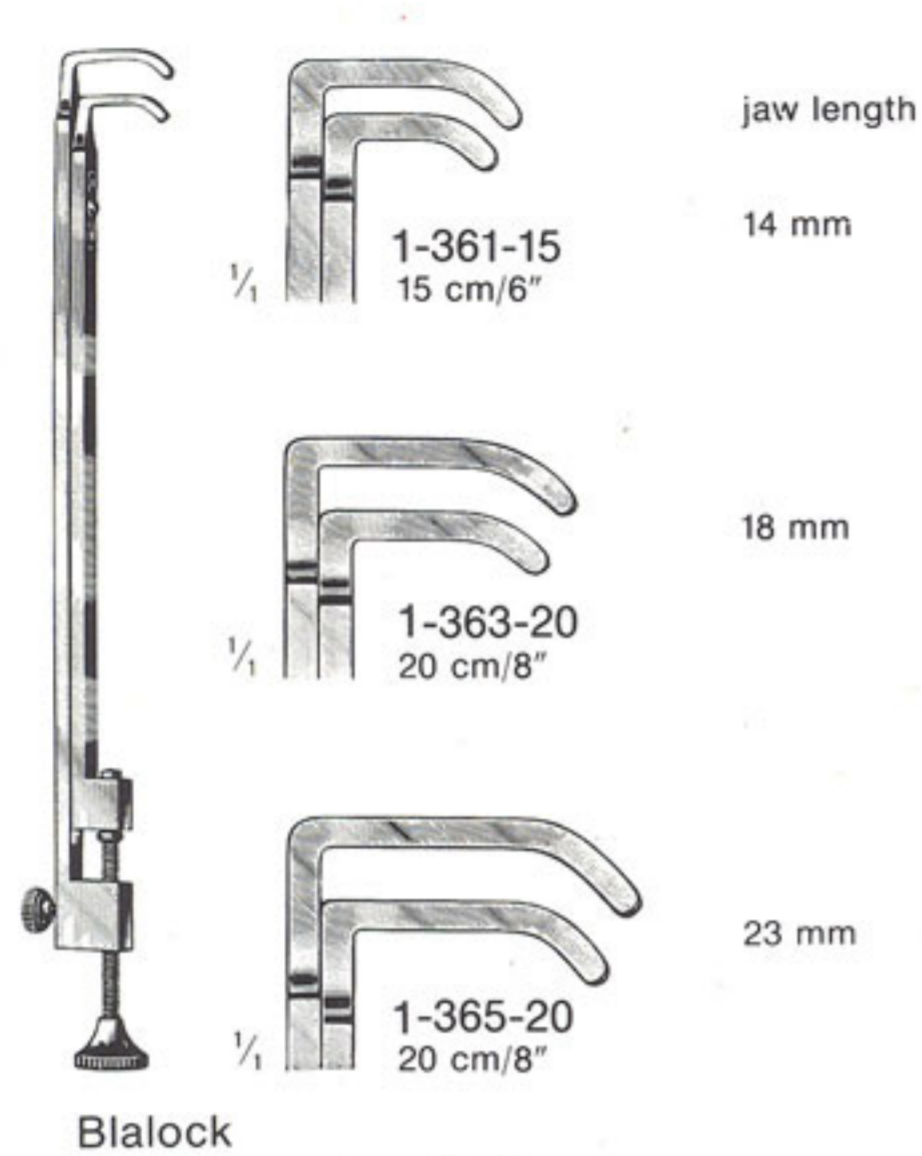

1-361-15 - 1-371-26 | Pulmonic Stenosis Clamps
1-375-20 - 1-387-18 | Clamps for coarctation of aorta

Atrauma-Pinzetten mit De Bakey-Zahnung

Atrauma Forcep With De Bakey Toothing

Pinzas Atrauma con dentado De Bakey



Toothing according to De Bakey:

The traditional ATRAUMA Clamps. Apart from cardio-vascular surgery, they are also approved for other atraumatic application and surgery techniques. Firm and precise seizing of tissues, safe and delicately controlled clamping effect.

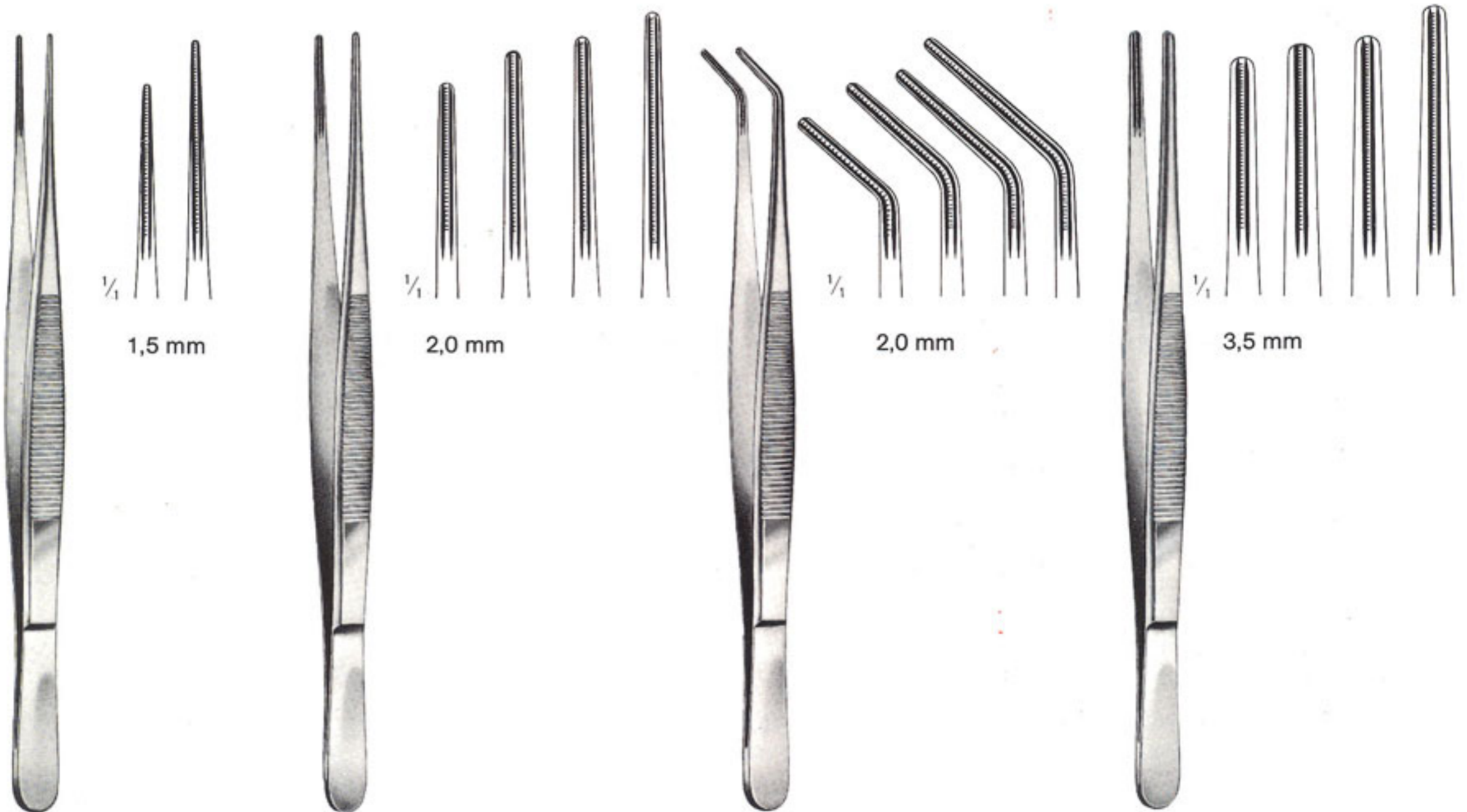

De Bakey

1-386-16 = 16 cm / 6 1/4"
1-386-20 = 20 cm / 8"

1-388-16 = 16 cm / 6 1/4"
1-388-20 = 20 cm / 8"
1-388-24 = 24 cm / 9 1/4"
1-388-30 = 30 cm / 12"

1-389-16 = 16 cm / 6 1/4"
1-389-20 = 20 cm / 8"
1-389-24 = 24 cm / 9 1/4"
1-389-30 = 30 cm / 12"

De Bakey

1-390-16 = 16 cm / 6 1/4"
1-390-20 = 20 cm / 8"
1-390-24 = 24 cm / 9 1/4"
1-390-30 = 30 cm / 12"

Atrauma-Bulldogklemmen

Atrauma Bulldog Clamps

Clamps Bulldog Atrauma



1-392-07
7,5 cm / 3"



1-392-08
8,5 cm / 3½"



1-392-10
10,5 cm / 4¼"



1-392-12
12 cm / 4¾"

1-392-07 - 1-392-12



1-393-07
7 cm / 2¾"



1-393-08
8 cm / 3¼"



1-393-10
10 cm / 4"



1-393-12
11,5 cm / 4¾"

natural size

1-393-07 - 1-393-12



1-395-23
23 cm / 9"

Atrauma-Bulldogklemmen

Atrauma Bulldog Clamps

Clamps Bulldog Atrauma

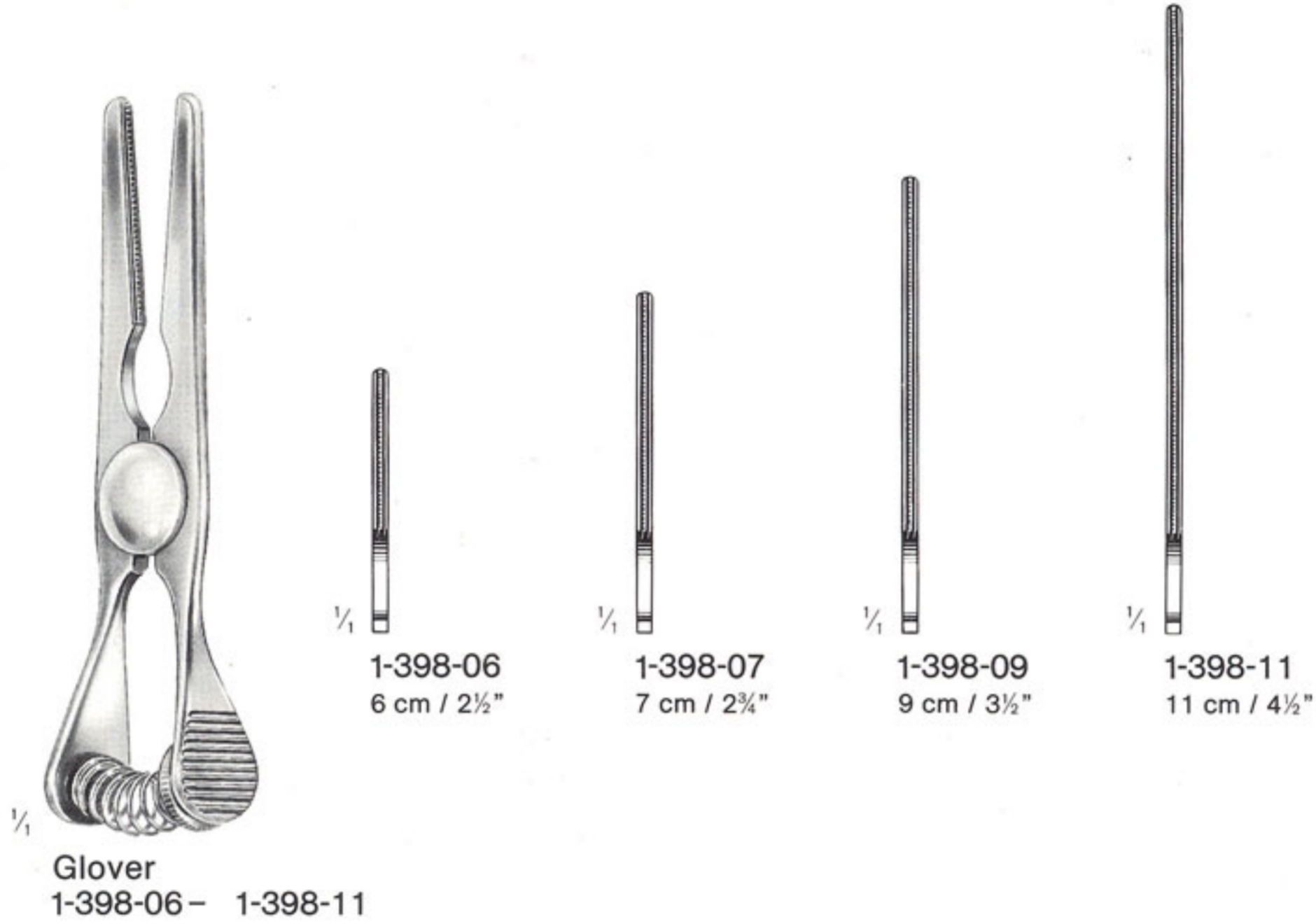

natural size

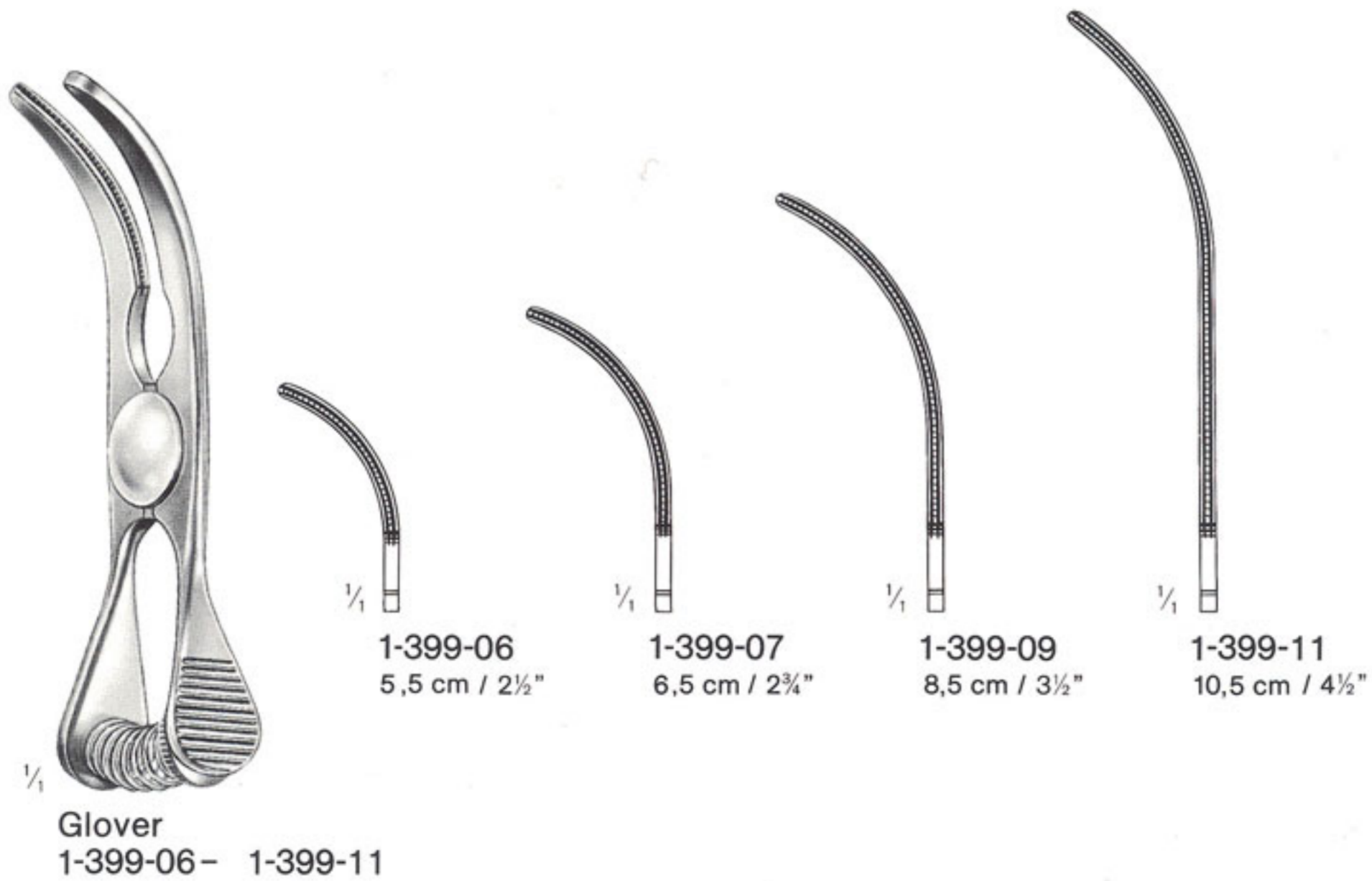

Atrauma-Gefäßklemmen mit De Bakey-Zahnung

Atrauma Blood Vessel Forceps

Atrauma Pinzas para vasos con

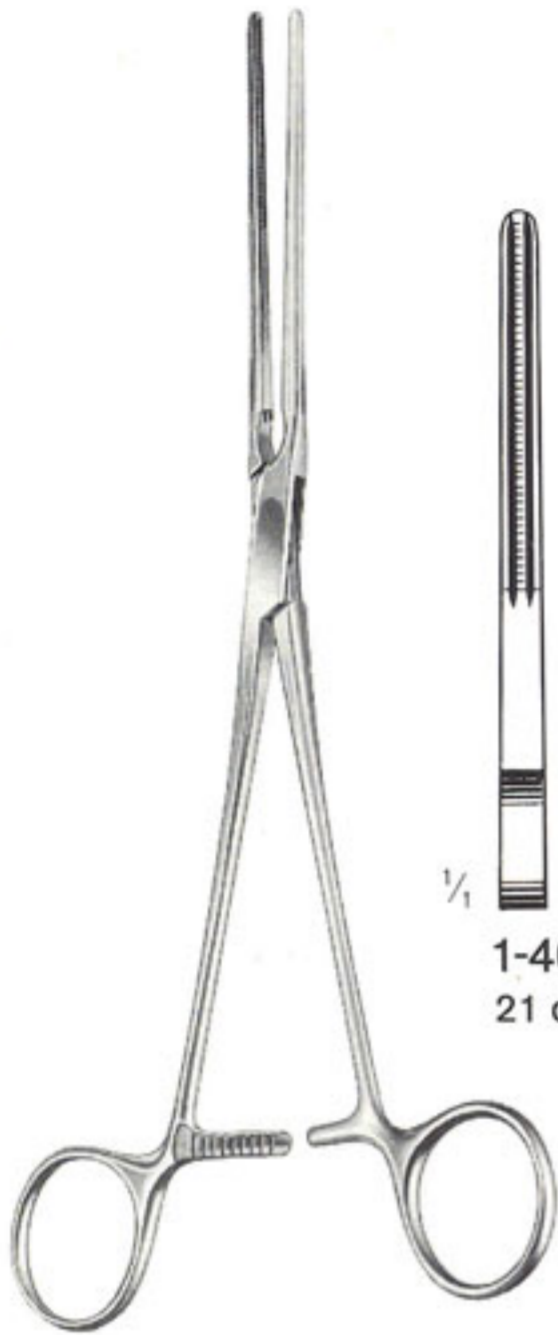

Potts

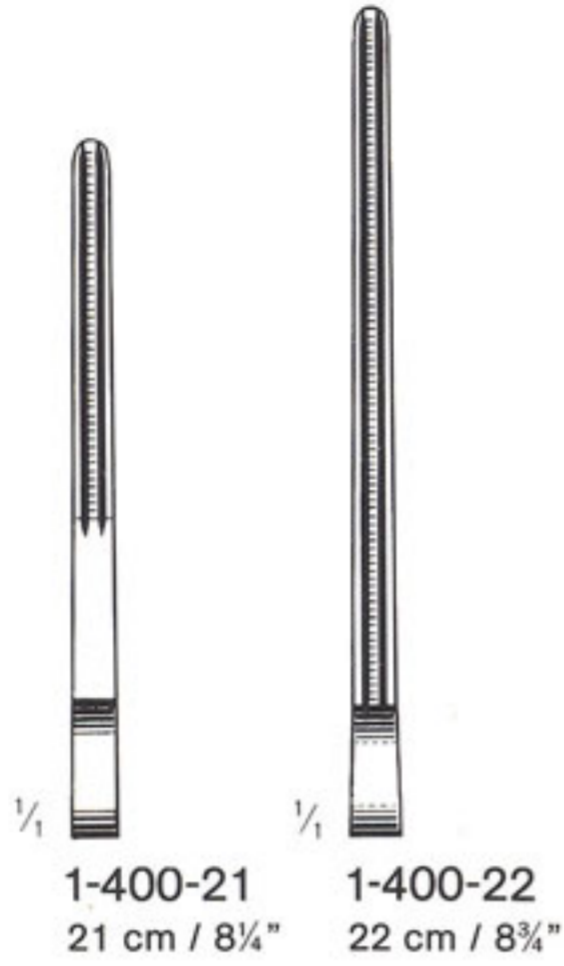

Potts

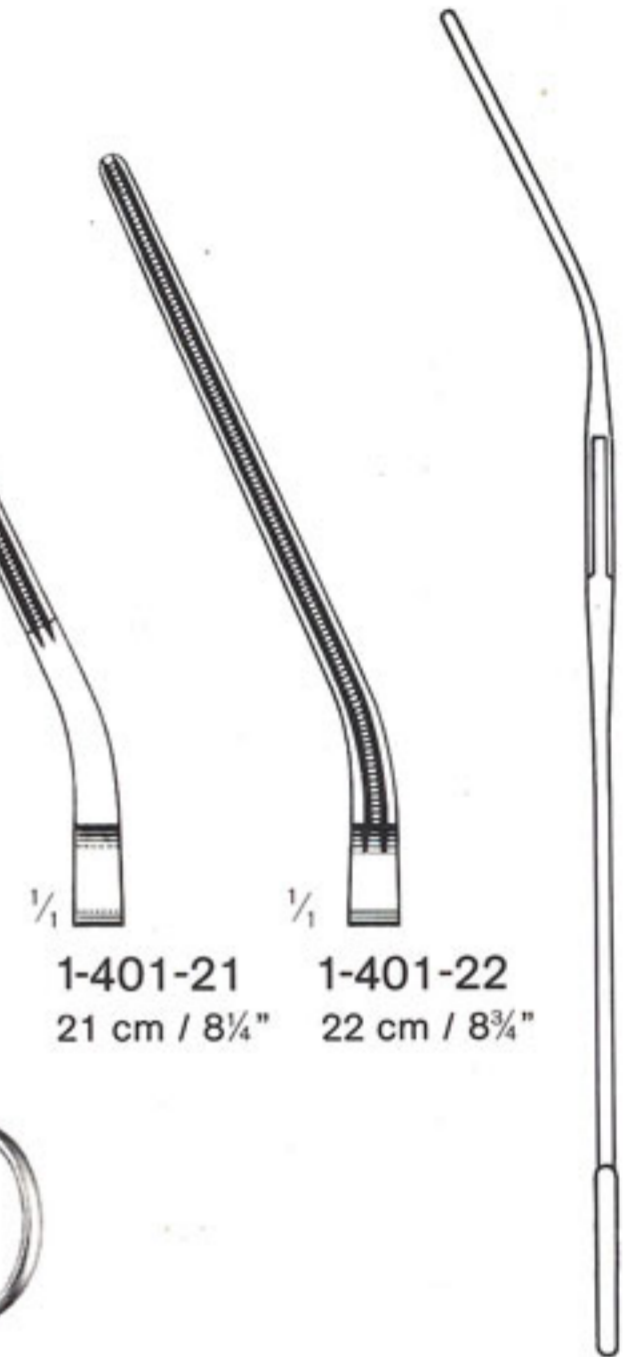

Potts
1-403-21 - 1-403-22



Potts
1-405-22
22 cm / 8 3/4"



1/2

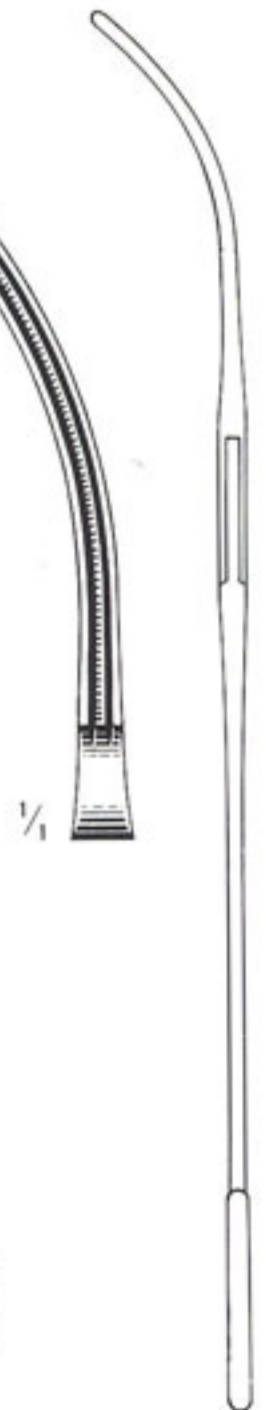

Atrauma-Gefäßklemmen mit De Bakey-Zahnung

Atrauma Blood Vessel Forceps

Atrauma Pinzas para vasos con

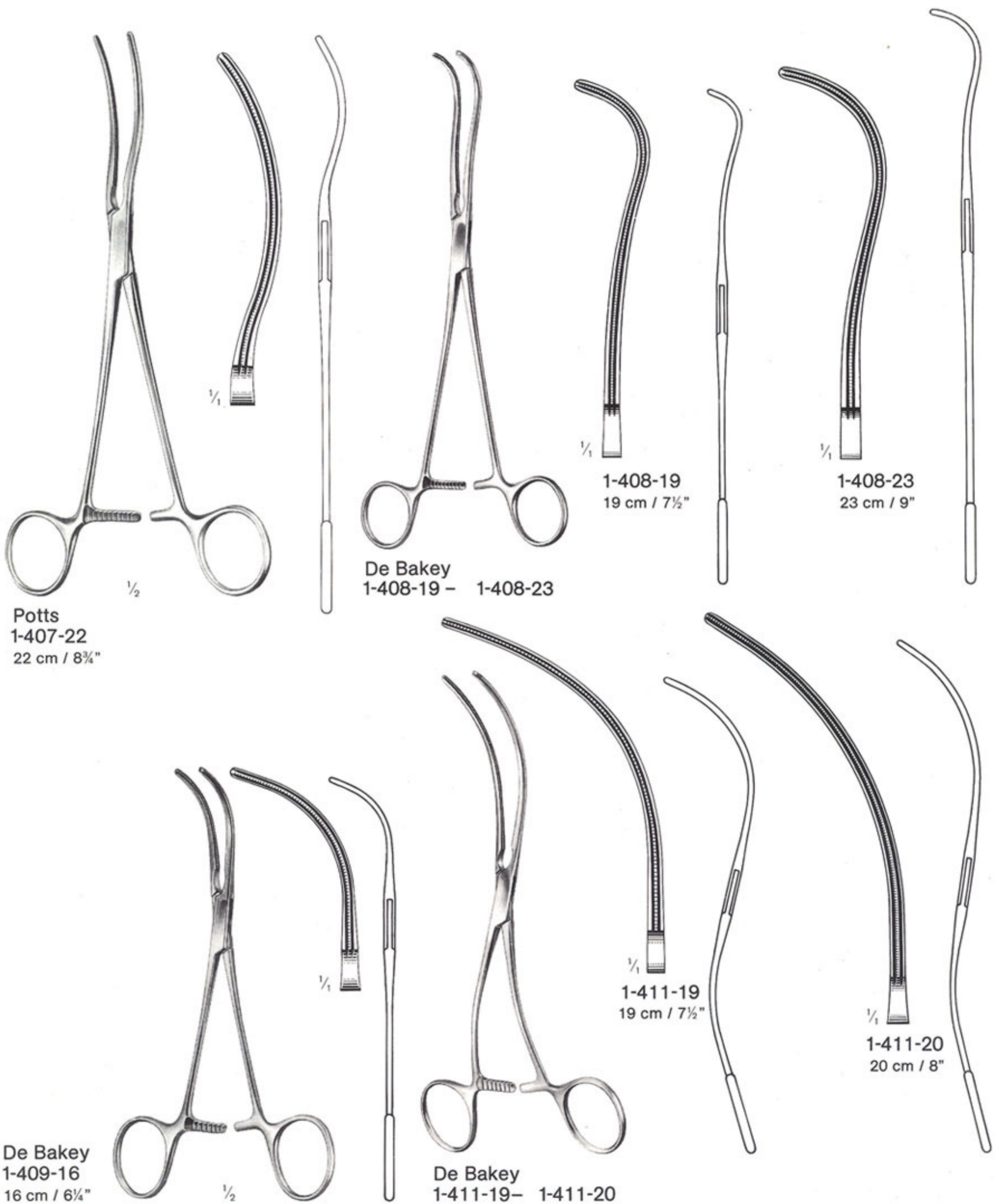

Atrauma-Gefäßklemmen mit De Bakey-Zahnung

Atrauma Blood Vessel Forceps

Atruma Pinzas para vasos con

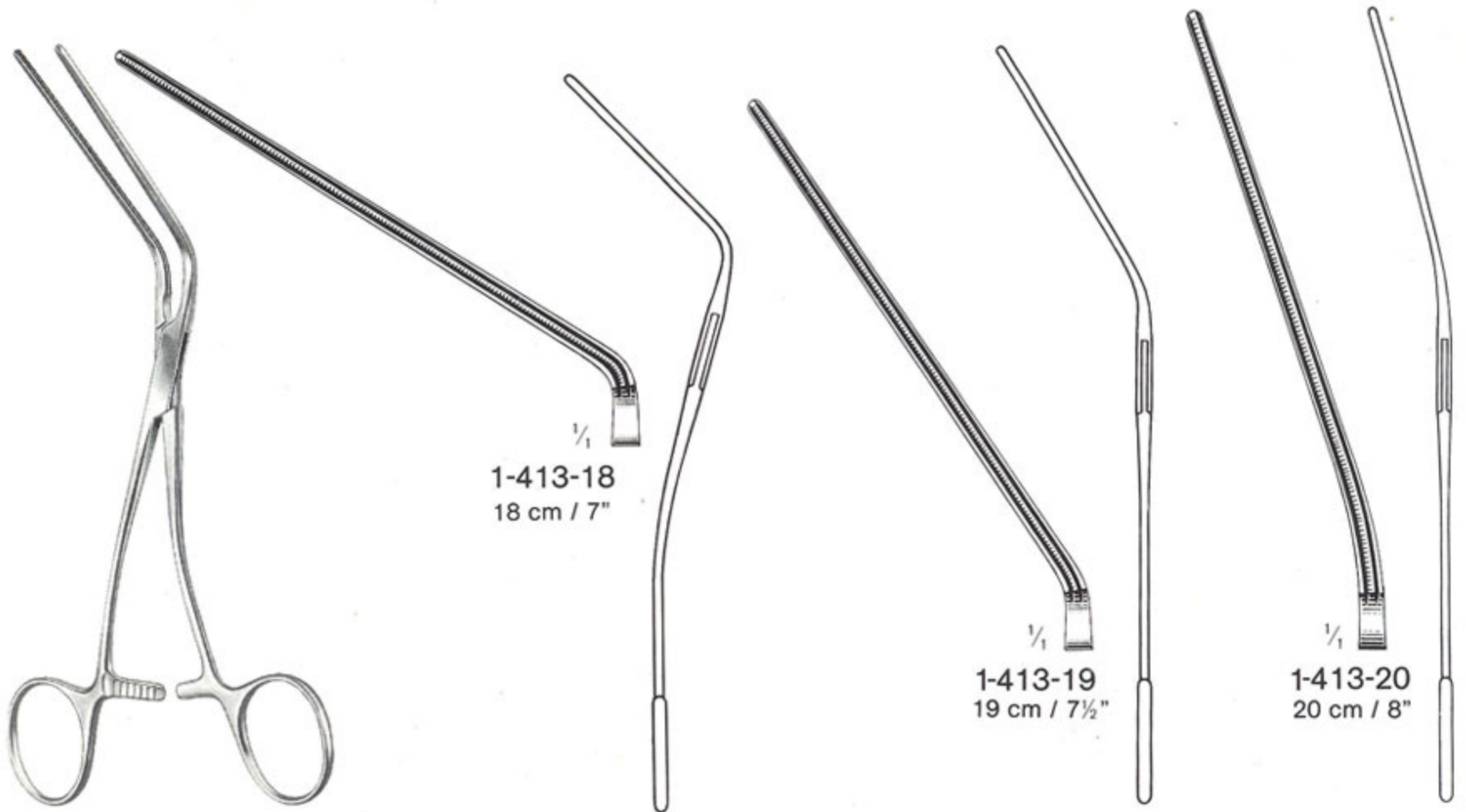

Leland-Jones
1-413-18 – 1-413-20

1/1
1-413-18
18 cm / 7"

1/1
1-413-19
19 cm / 7½"

1/1
1-413-20
20 cm / 8"

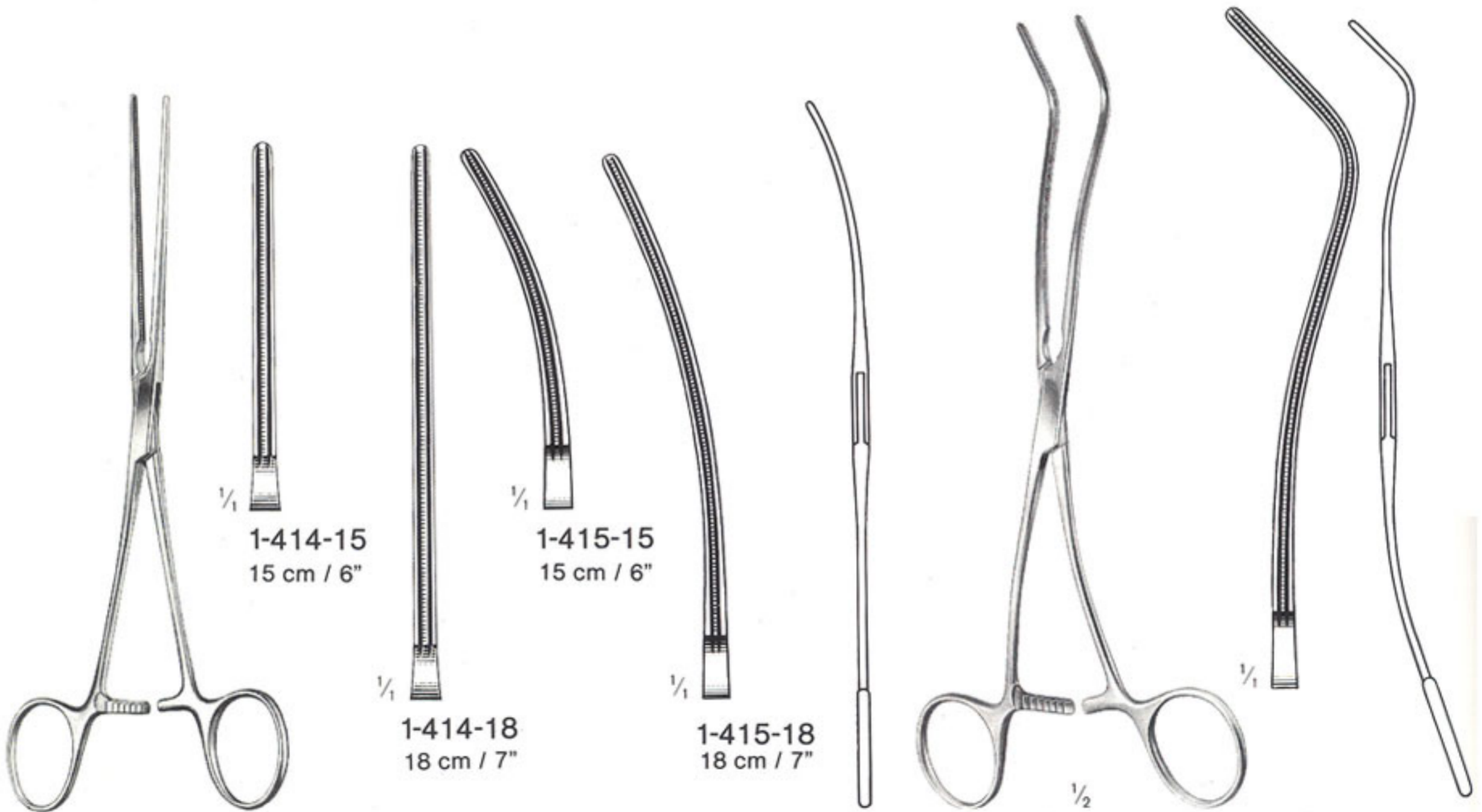

Bainbridge
1-414-15 = 15 cm / 6"
1-414-18 = 18 cm / 7"

1/1
1-414-15
15 cm / 6"

1/1
1-415-15
15 cm / 6"

1/1
1-414-18
18 cm / 7"

1/1
1-415-18
18 cm / 7"

1/2
De Bakey
1-416-20
20 cm / 8"

Atrauma-Gefäßklemmen mit De Bakey-Zahnung

Atrauma Blood Vessel Forceps

Atruma Pinzas para vasos con

A precise double ratchet holds the Clamp-Forceps reliably locked

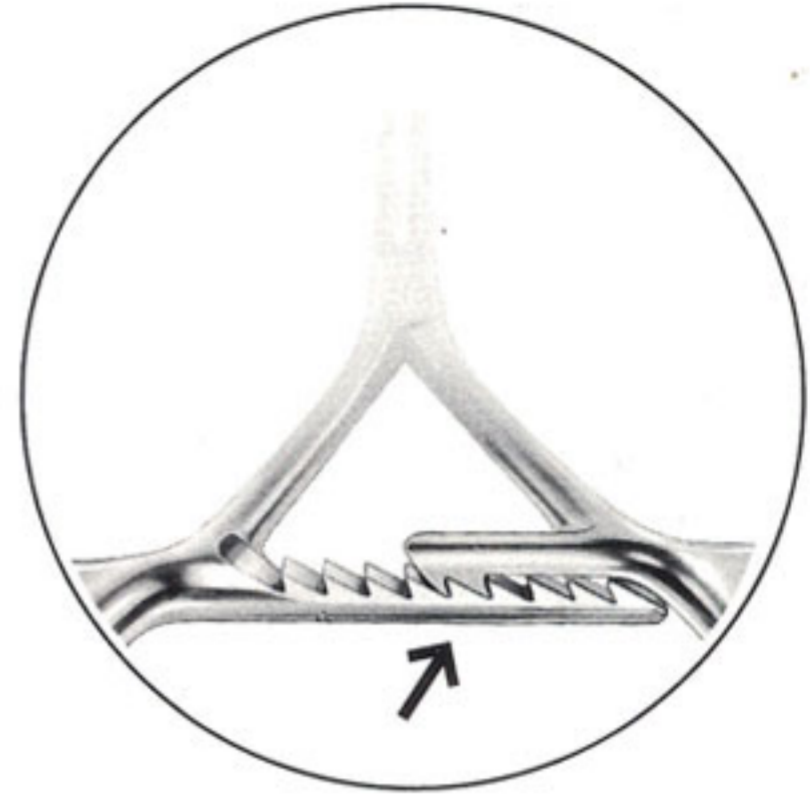

1-417-26 - 1-417-33

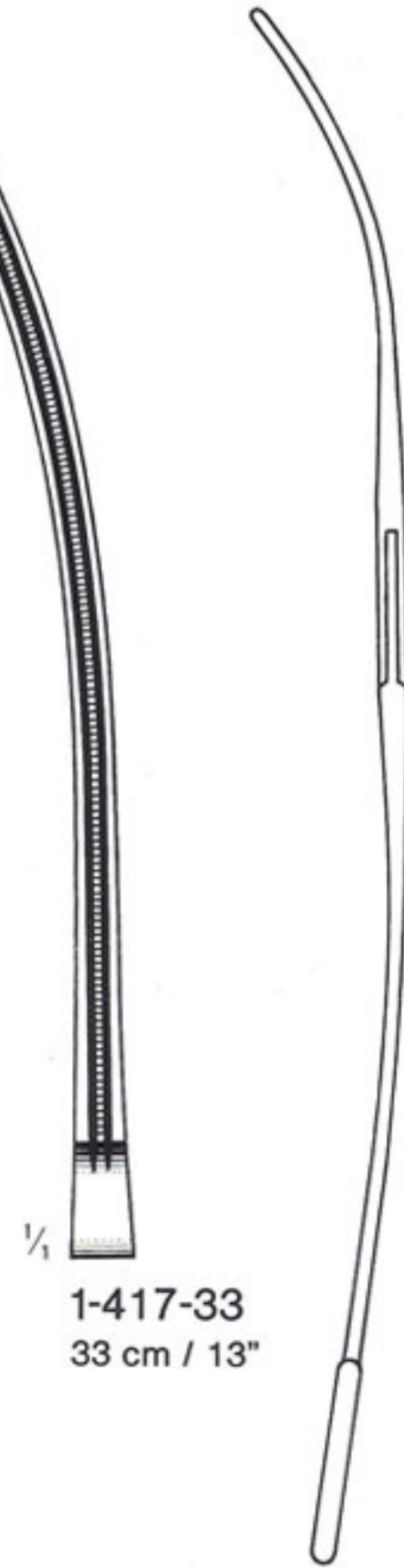

Atrauma-Gefäßklemmen mit De Bakey-Zahnung
Atrauma Blood Vessel Forceps
Atruma Pinzas para vasos con

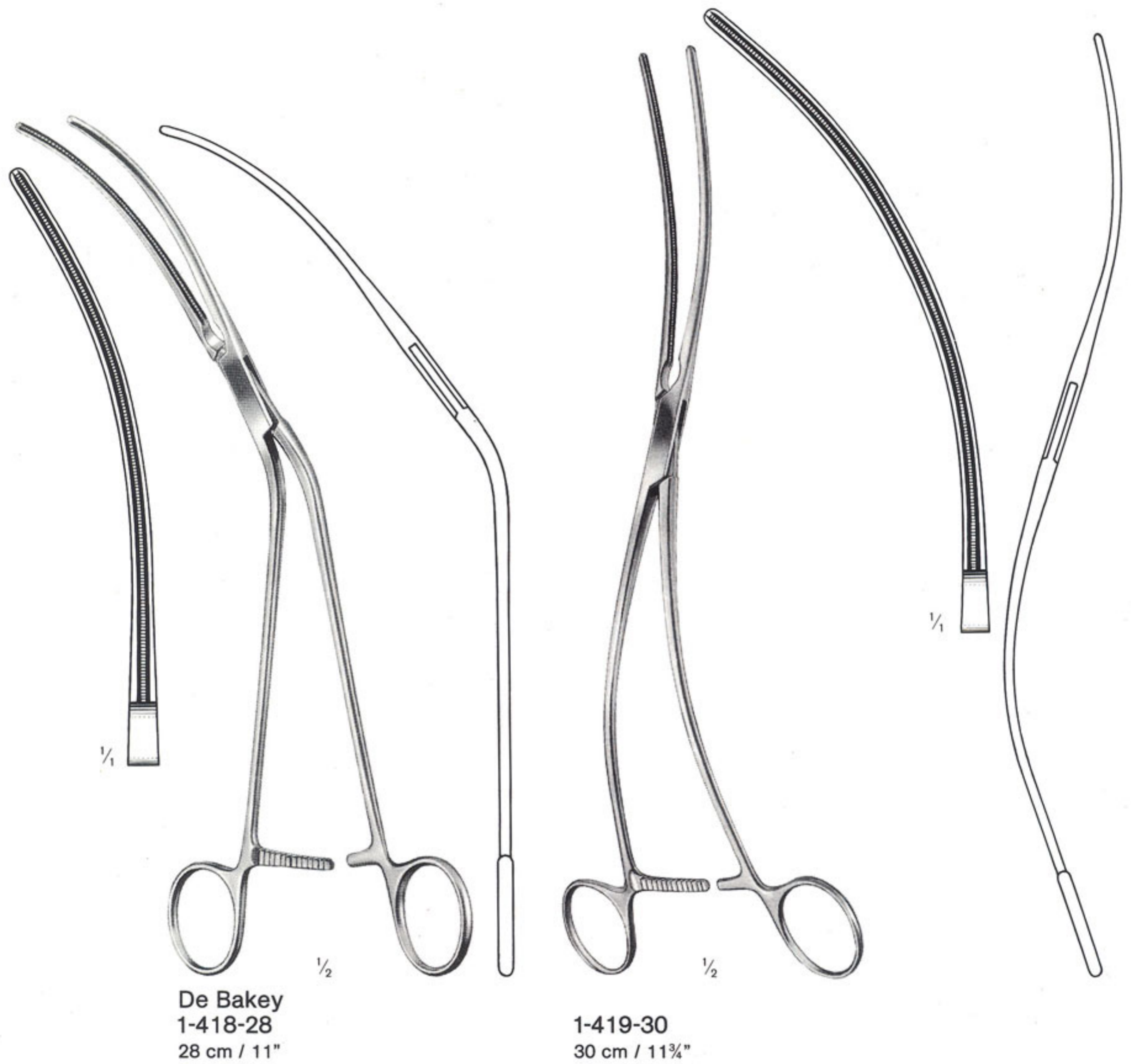

Atrauma-Gefäßklemmen mit De Bakey-Zahnung

Atrauma Blood Vessel Forceps

Atrauma Pinzas para vasos con

Top view

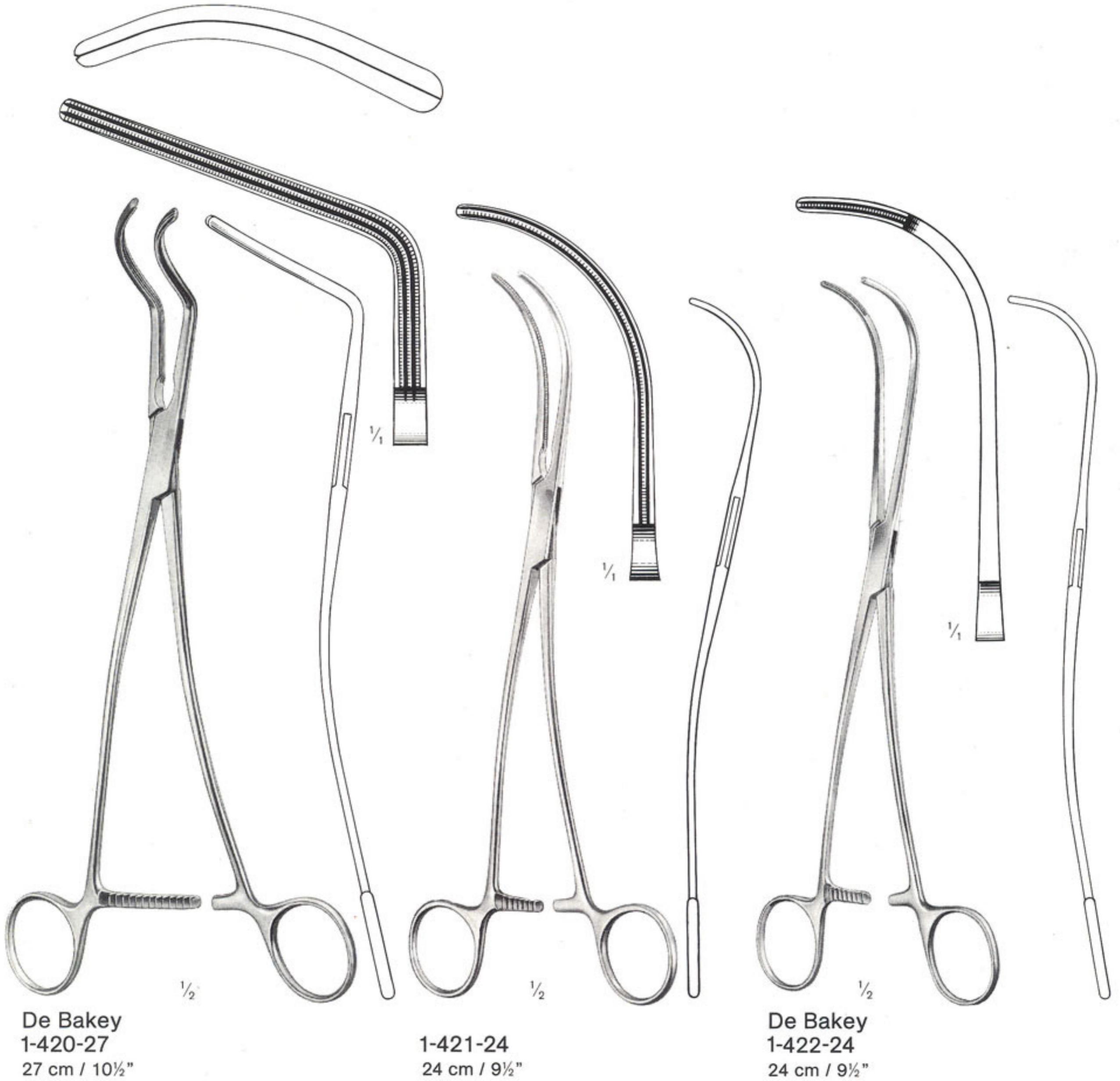

Atrauma-Gefäßklemmen mit De Bakey-Zahnung
Atrauma Blood Vessel Forceps
Atruma Pinzas para vasos con



De Bakey
1-423-25
25 cm / 10"



De Bakey
1-423-26
26 cm / 10"

Atrauma-Gefäßklemmen mit De Bakey-Zahnung

Atrauma Blood Vessel Forceps

Atruma Pinzas para vasos con



$\frac{1}{4}$
Weber
1-424-02
26 cm / 10 $\frac{1}{4}$ "

Weber
1-424-01
26 cm / 10 $\frac{1}{4}$ "

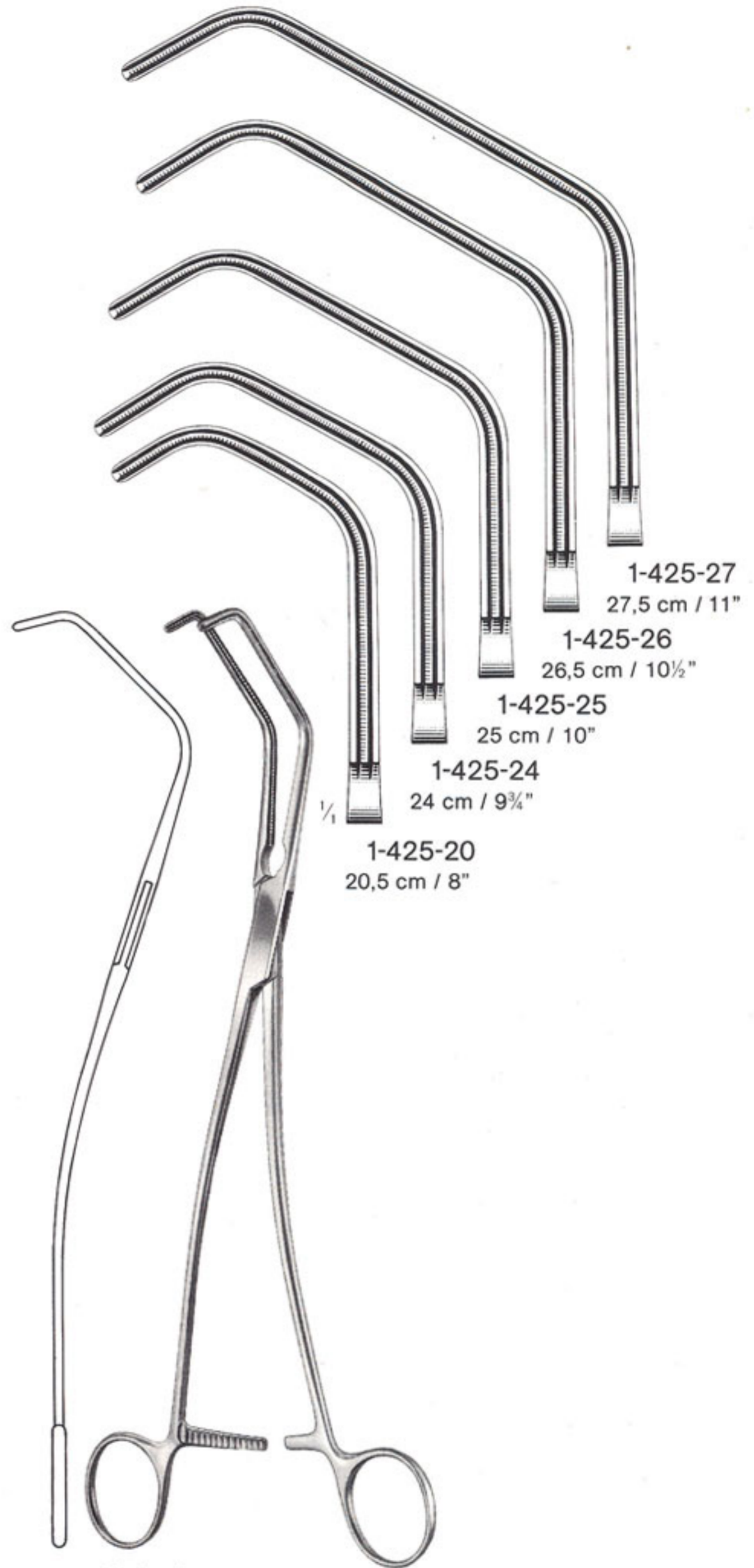

1-425-27
27,5 cm / 11"
1-425-26
26,5 cm / 10 $\frac{1}{2}$ "
1-425-25
25 cm / 10"
1-425-24
24 cm / 9 $\frac{3}{4}$ "
1-425-20
20,5 cm / 8"

Satinsky
1-425-20 - 1-425-27

Atrauma-Gefäßklemmen mit De Bakey-Zahnung

Atrauma Blood Vessel Forceps

Atruma Pinzas para vasos con

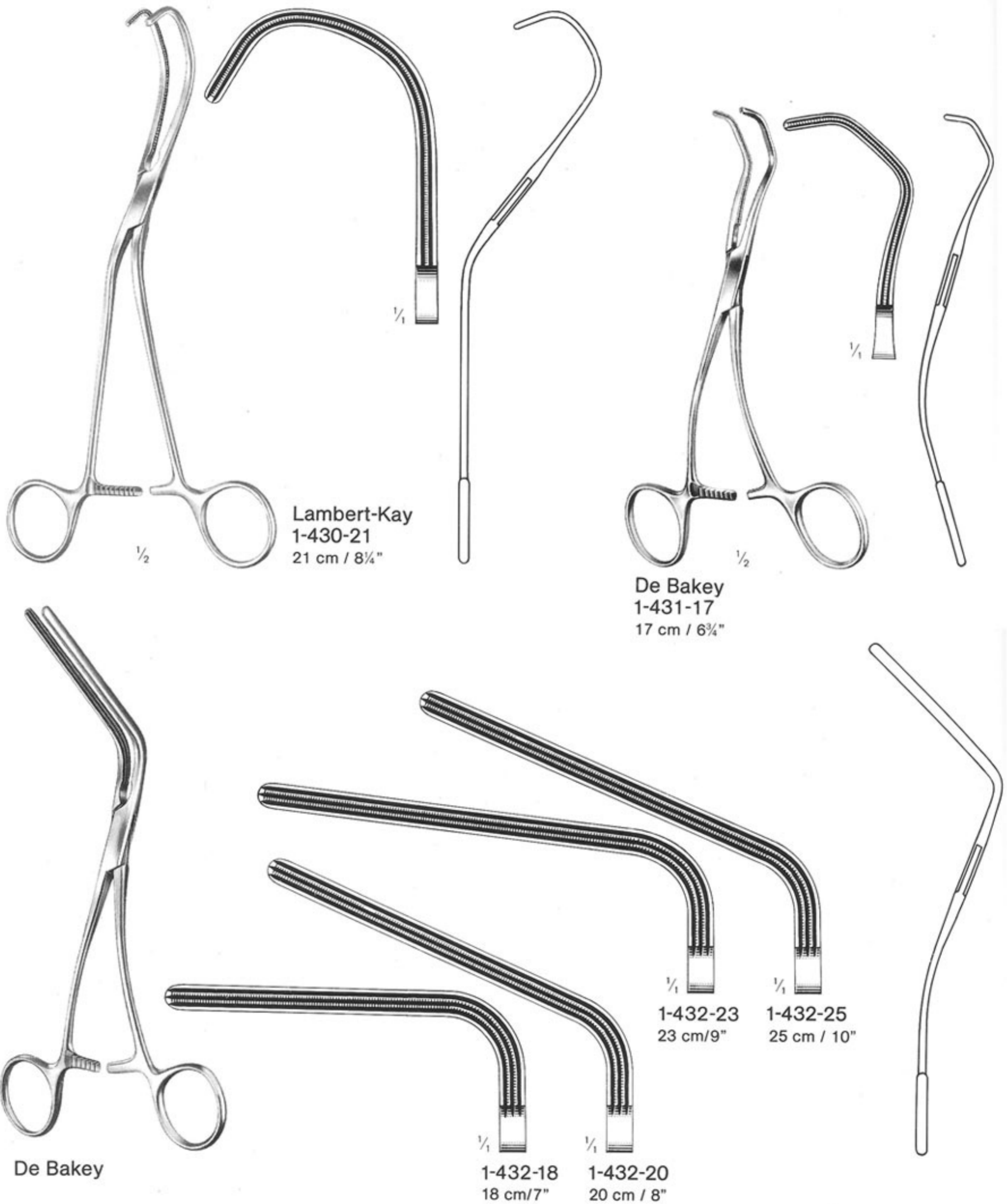

Atrauma-Gefäßklemmen mit De Bakey-Zahnung Atrauma Blood Vessel Forceps Atruma Pinzas para vasos con

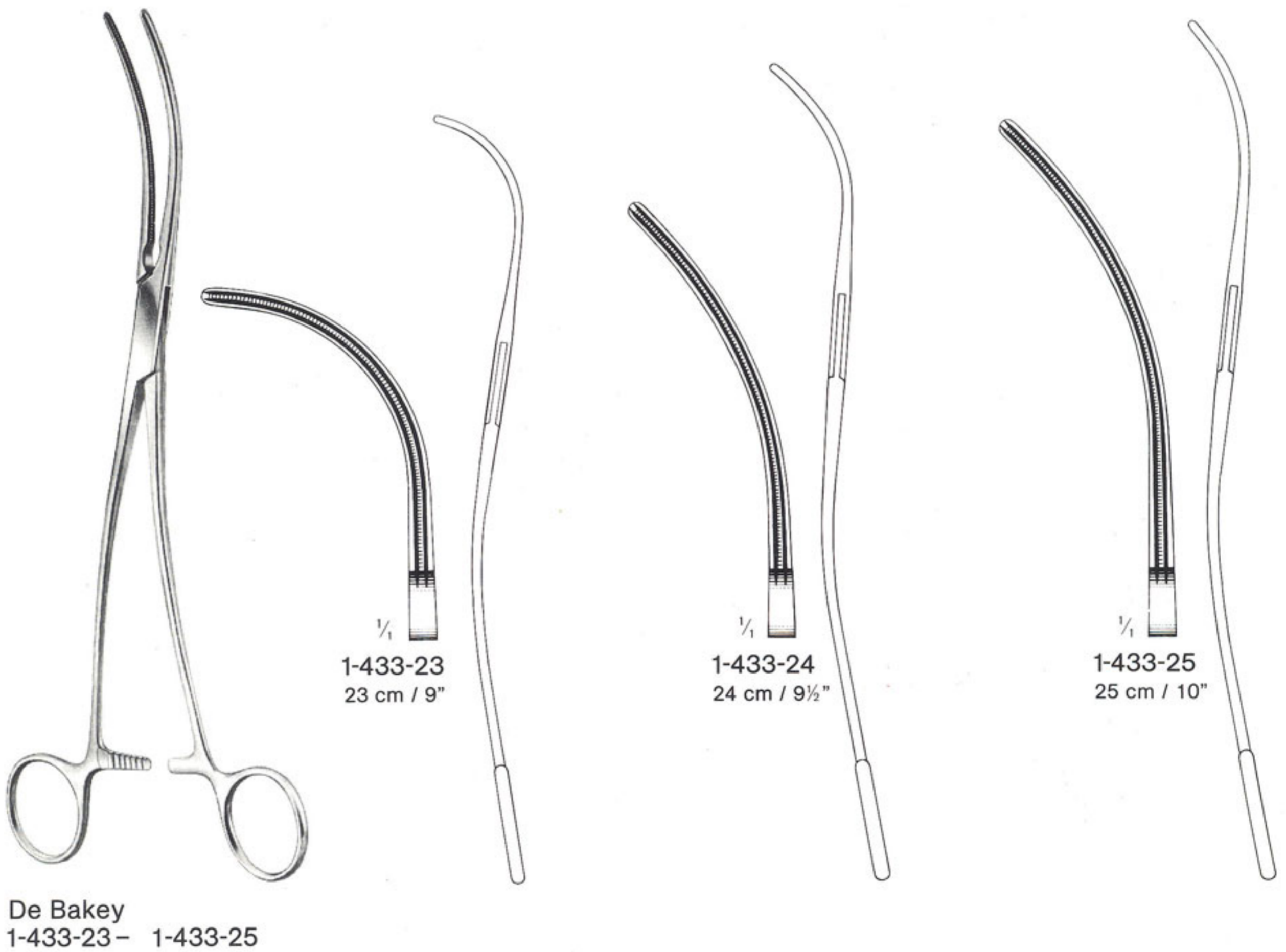

Atrauma-Gefäßklemmen mit De Bakey-Zahnung

Atrauma Blood Vessel Forceps

Atrauma Pinzas para vasos con

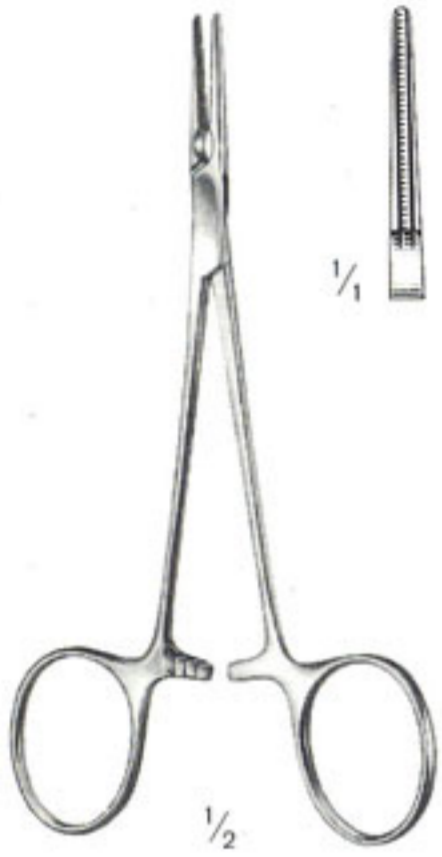

Mosquito
1-438-12
12 cm / 4 3/4"

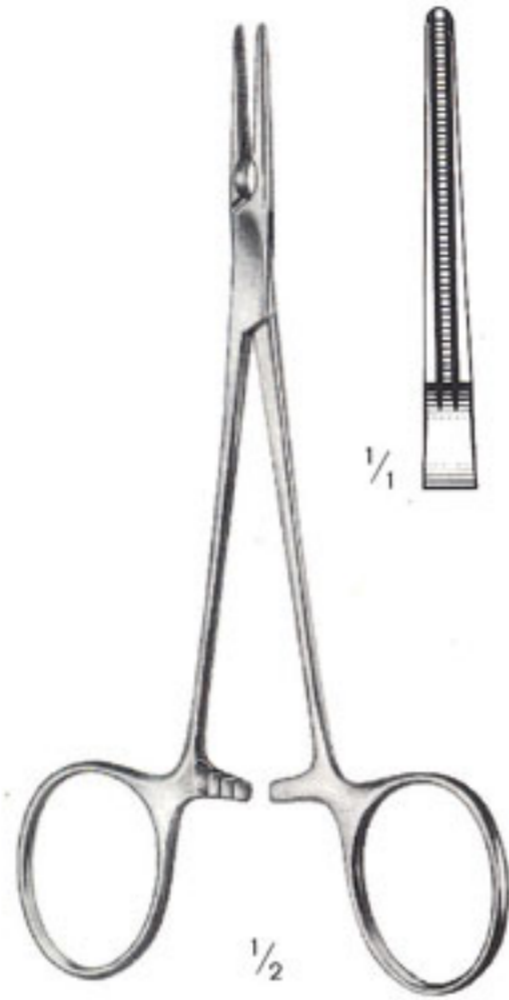

Péan
1-438-14
14 cm / 5 3/4"

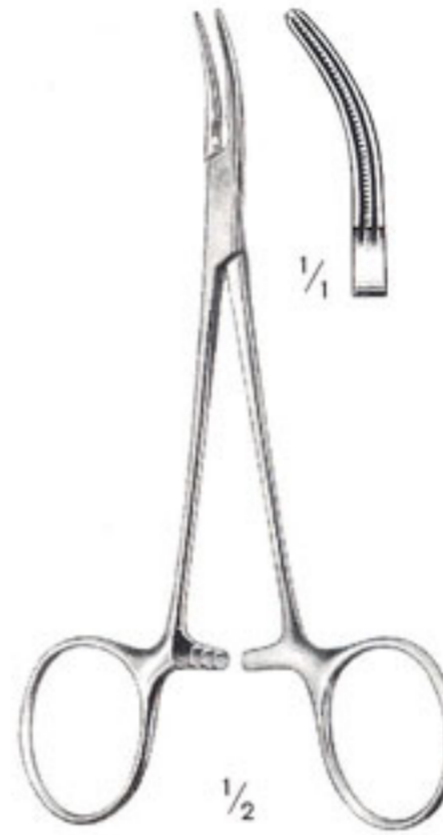

Mosquito
1-439-12
12 cm / 4 3/4"

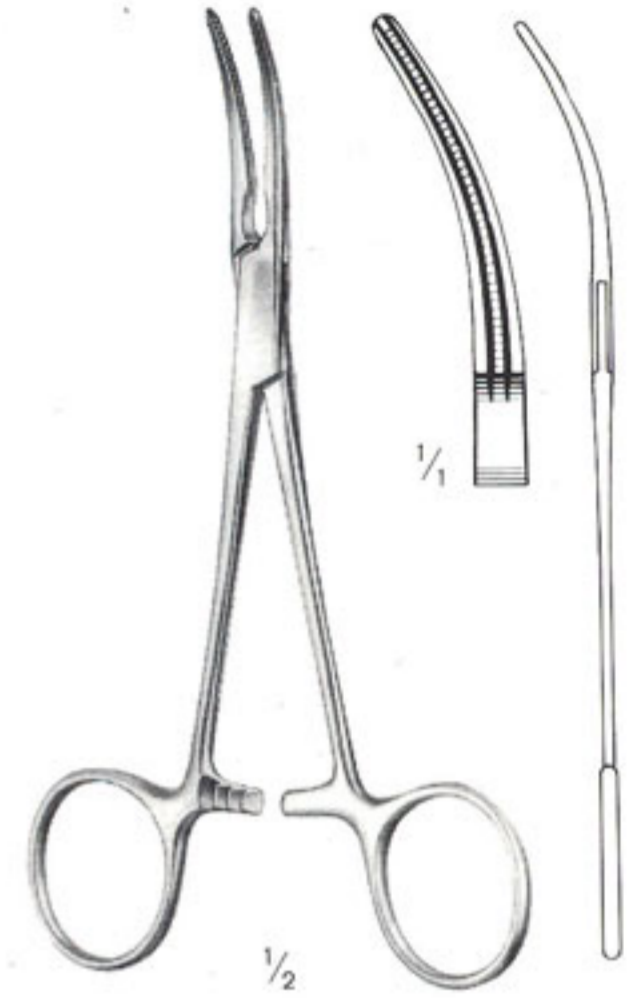

Péan
1-439-14
14 cm / 5 3/4"



De Bakey
1-440-17
17 cm / 6 1/4"

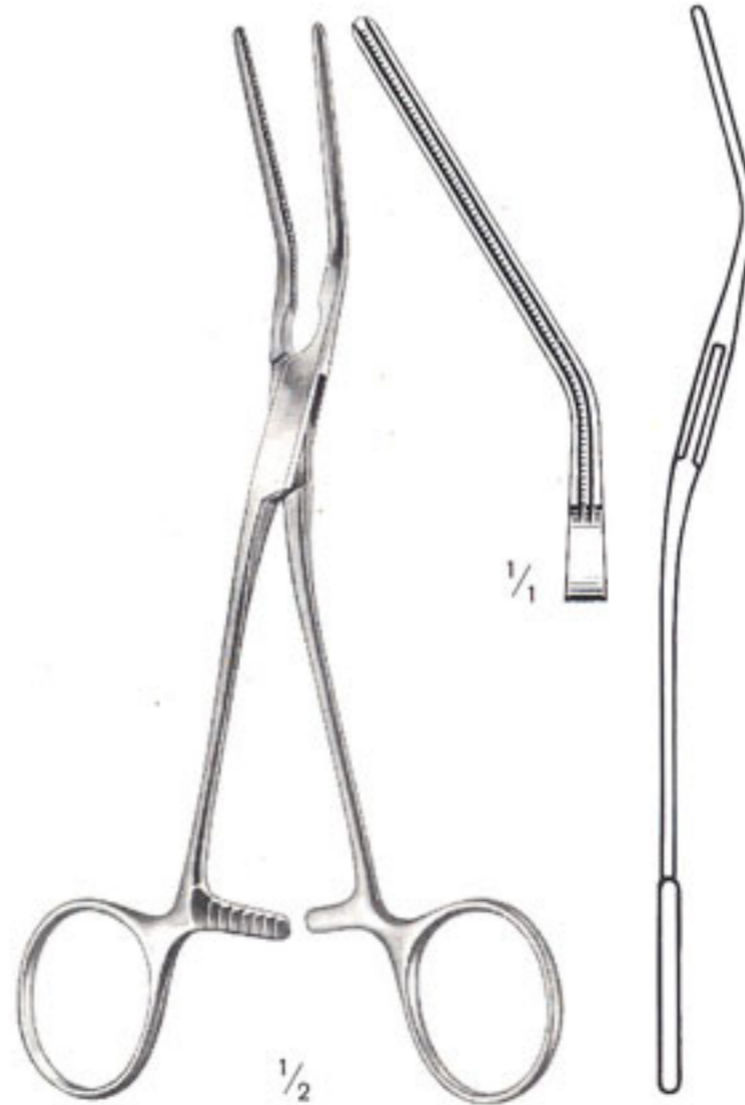

De Bakey
1-441-16
16 cm / 6"



De Bakey
1-443-15
15 cm / 6"

Atrauma-Gefäßklemmen mit De Bakey-Zahnung

Atrauma Blood Vessel Forceps

Atruma Pinzas para vasos con



De Bakey
1-445-15
15 cm / 6"



De Bakey
1-447-17
17 cm / 6 3/4"

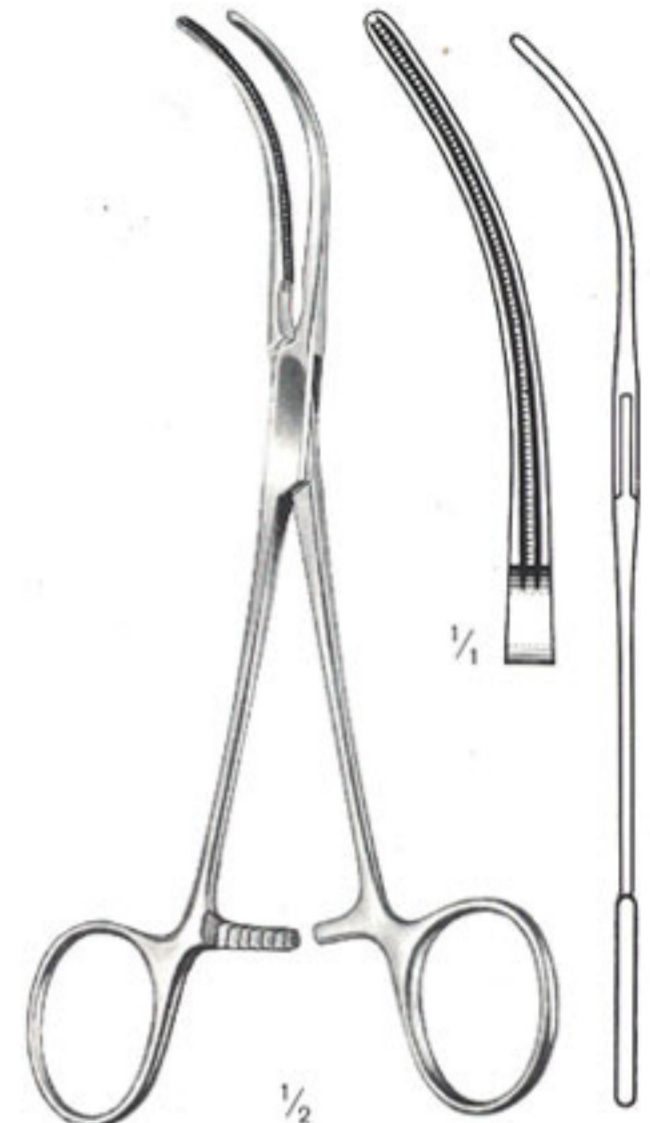

Glover
1-449-17
17 cm / 6 3/4"

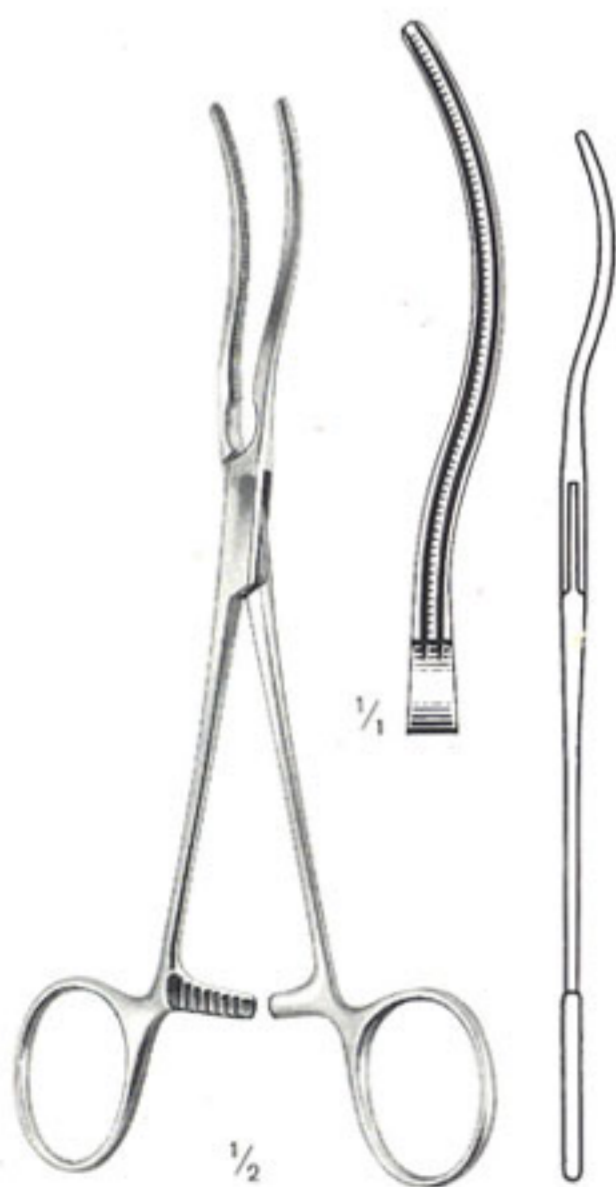

1-451-17
17 cm / 6 3/4"

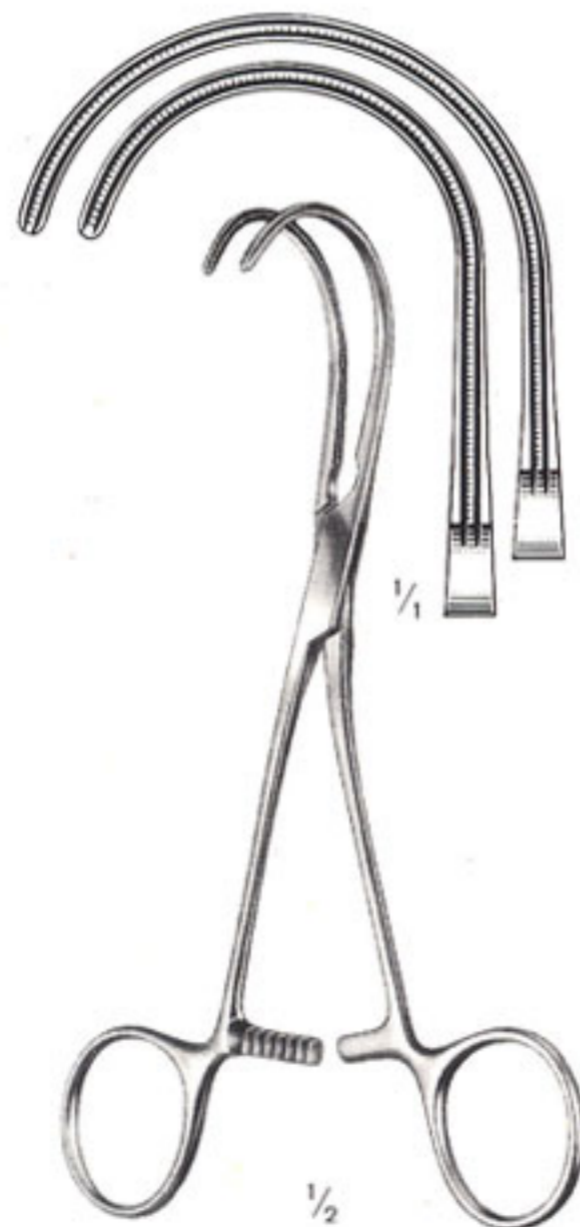

1-453-16 = 16 cm / 6 1/4"
1-455-17 = 17 cm / 6 3/4"



Derra
1-456-16 - 1-456-18

1-456-16
16 cm / 6 1/4"

1-456-17
17 cm / 6 3/4"

1-456-18
18 cm / 7"

Atrauma-Gefäßklemmen mit De Bakey-Zahnung

Atrauma Blood Vessel Forceps

Atruma Pinzas para vasos con



Beck
1-457-17
17 cm / 6³/₄"

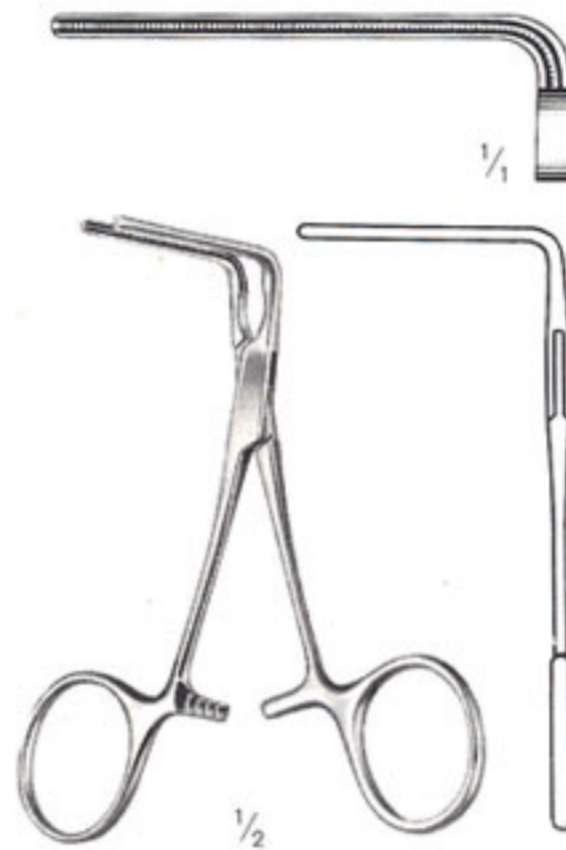

De Bakey
1-458-10
10 cm / 4"

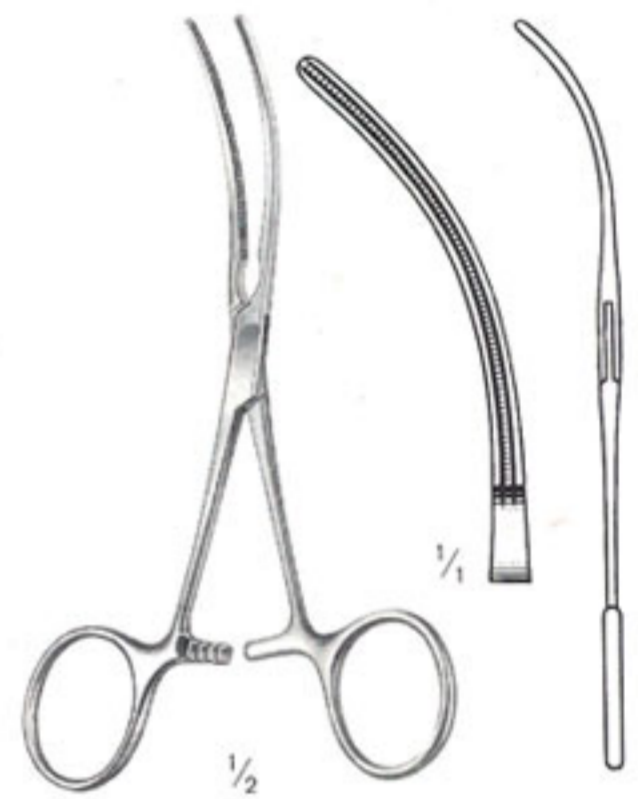

De Bakey
1-458-11
11 cm / 4¹/₄"



De Bakey
1-458-12
12 cm / 4³/₄"

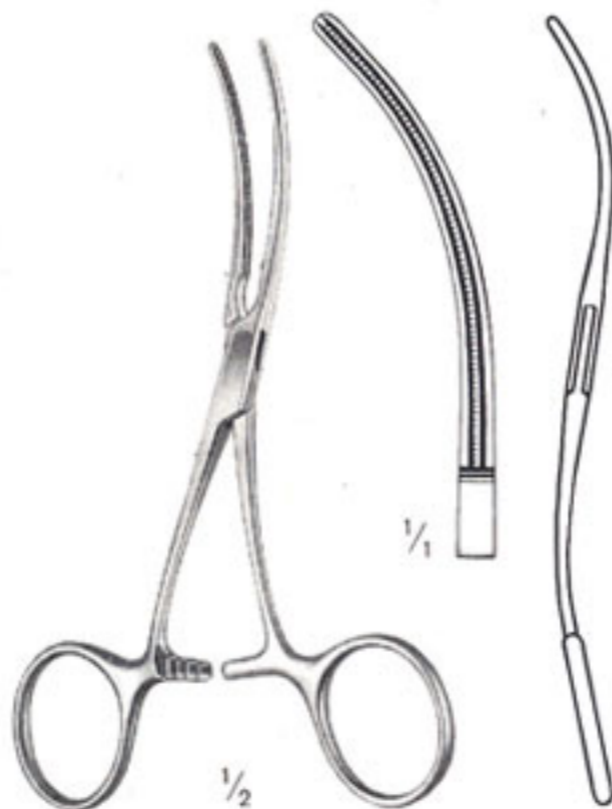

De Bakey
1-459-12
12 cm / 4³/₄"



De Bakey
1-459-13
13 cm / 5¹/₄"

Atrauma-Gefaßklemmen

Atrauma Artery Forcep and clamps

Pinzas Clamps Atrauma

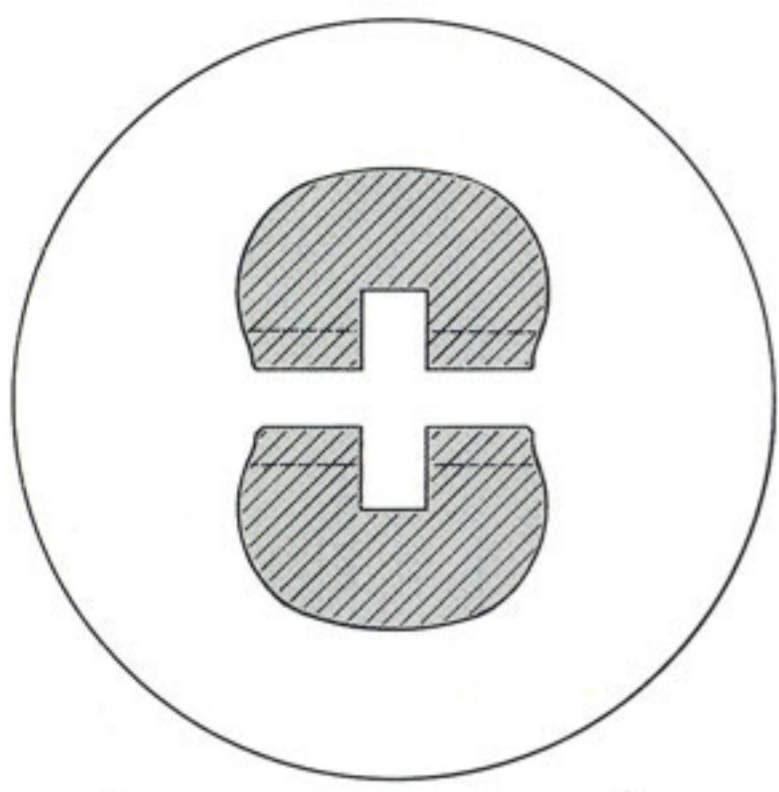

Tothing according to Cooley:
 Very narrow jaws for application in extremely limited operational field. Particularly approved for cardiovascular surgery and pediatry. Firm grip without squeezing.

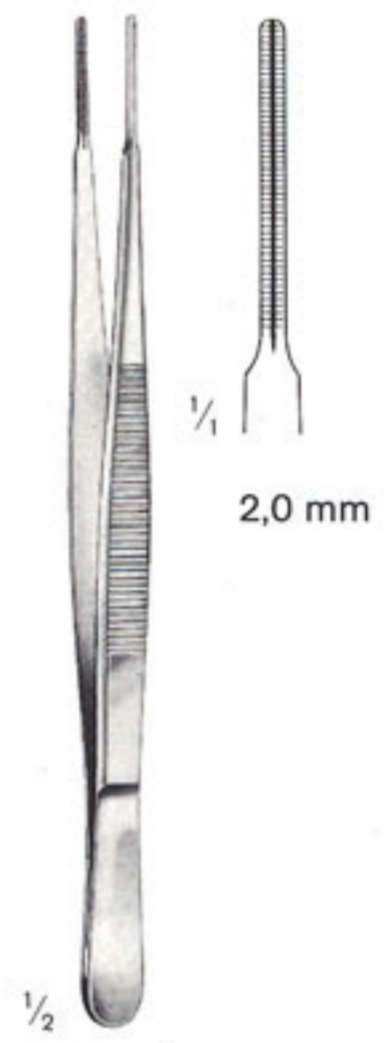

Cooley
 1-464-16 = 16 cm / 6 1/4"
 1-464-20 = 20 cm / 8"

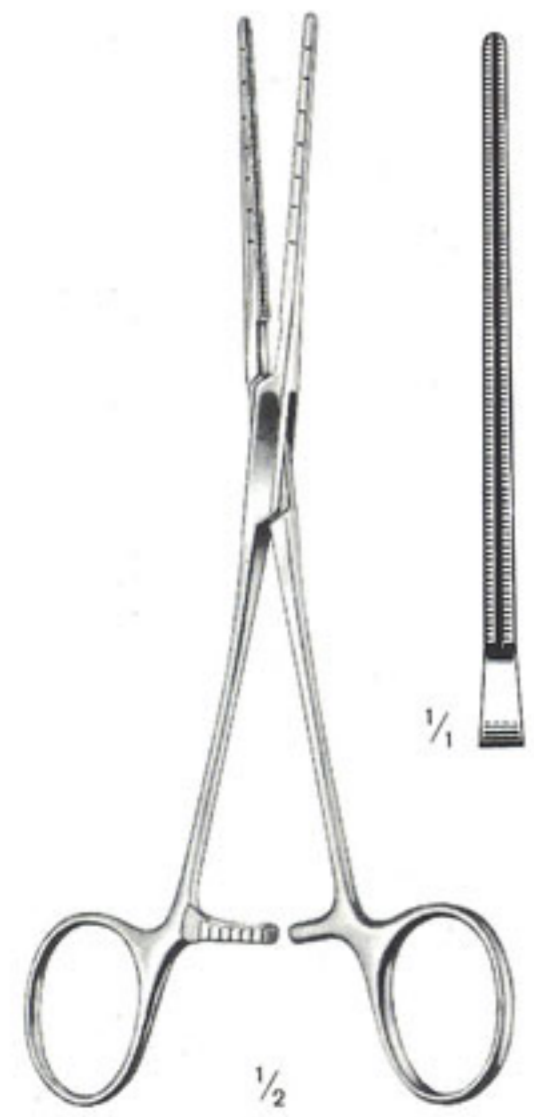

Cooley
 1-468-17
 17 cm / 6 3/4"

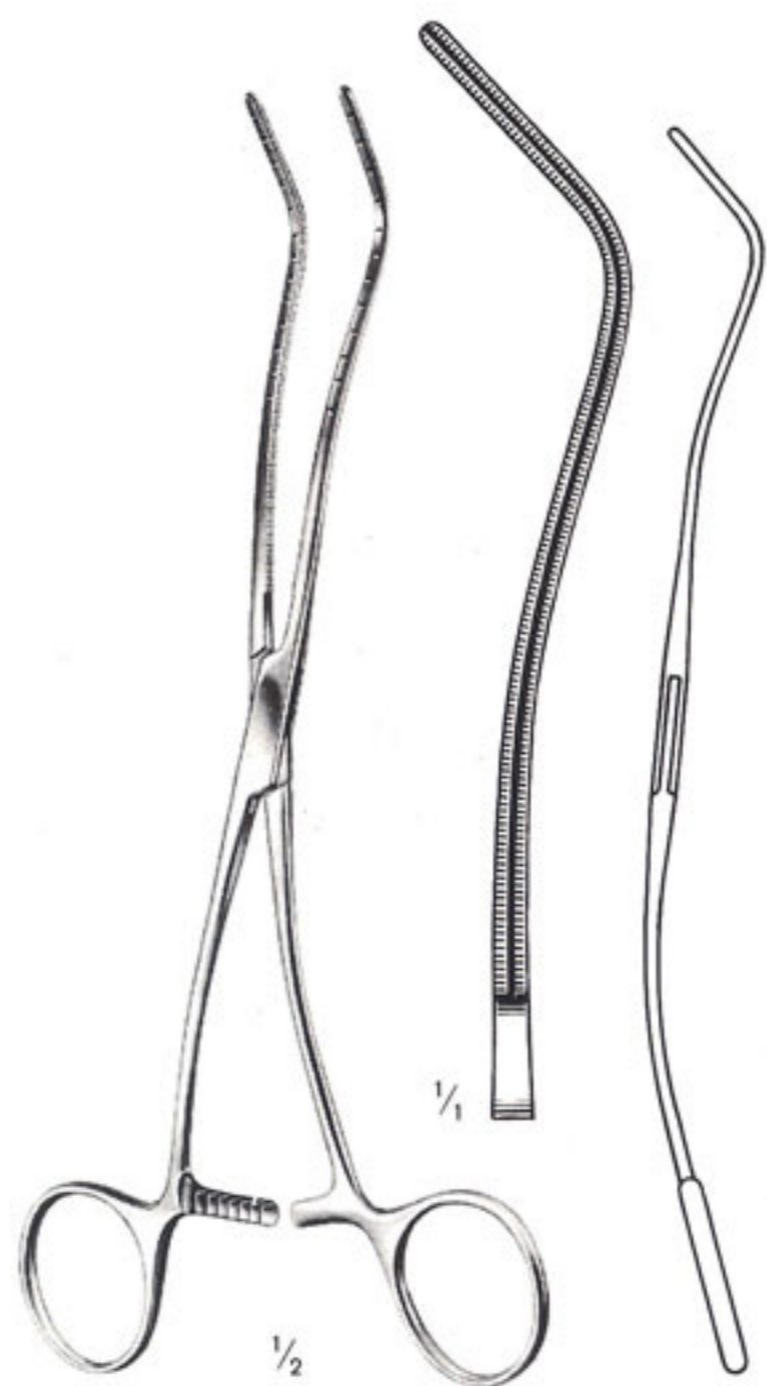

Cooley
 1-469-20
 20 cm / 8"

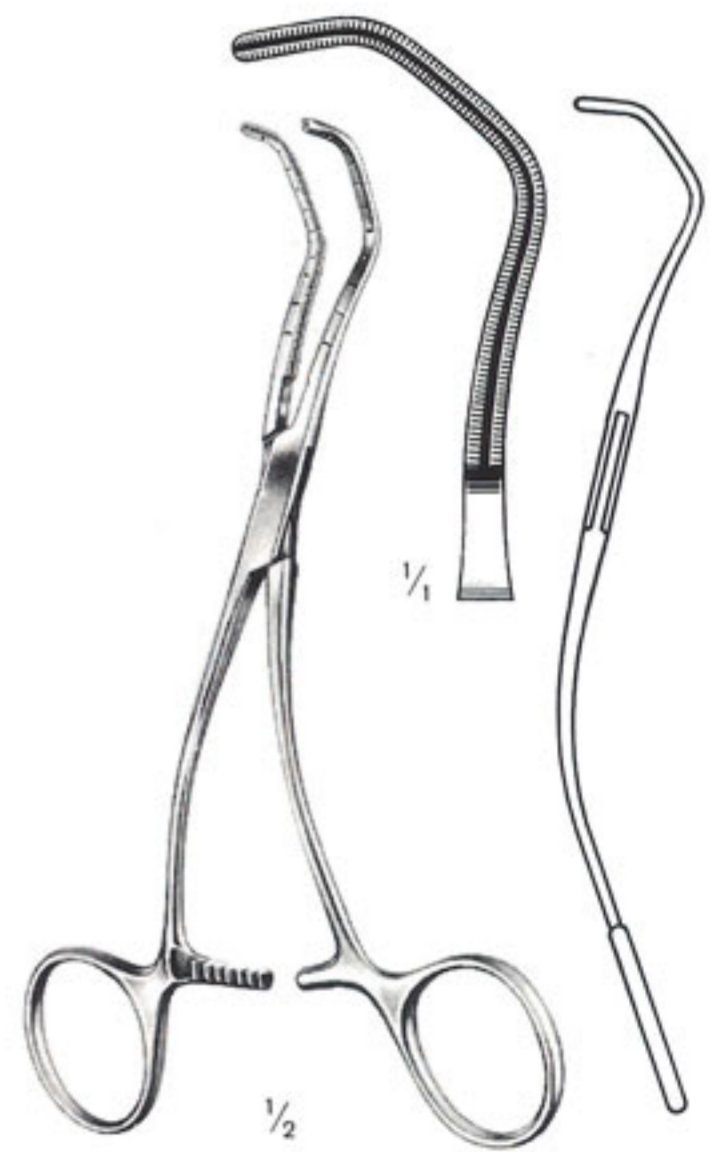

Cooley
 1-471-16
 16 cm / 6 1/4"

Atrauma-Gefaßklemmen

Atrauma Artery Forcep and clamps

Pinzas Clamps Atrauma



Cooley
1-472-15
15 cm / 6"

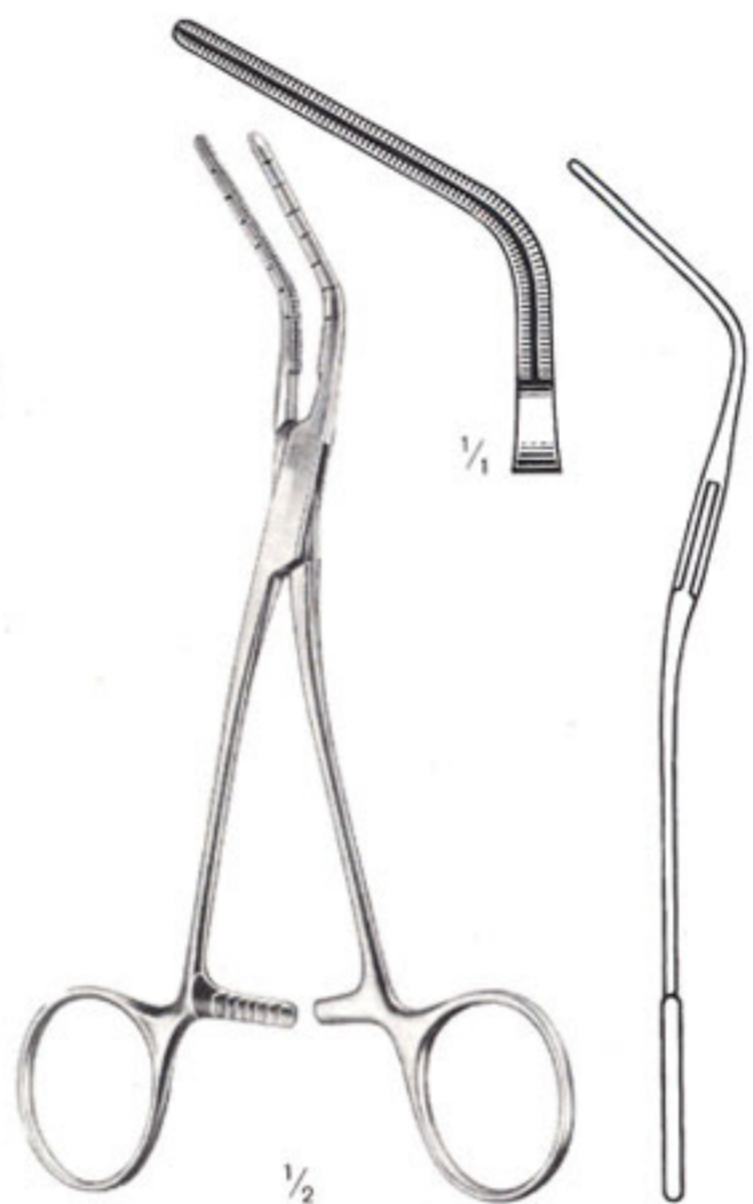

Cooley
1-472-16
15,5 cm / 6 1/8"

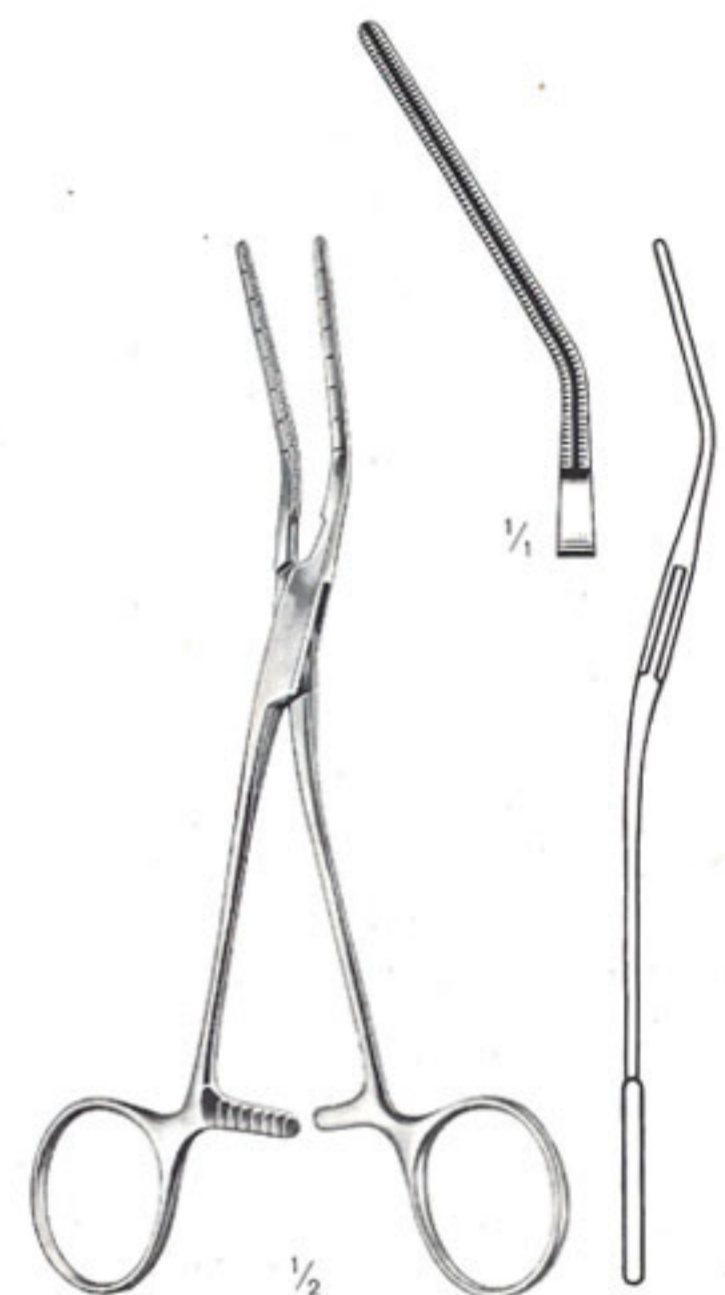

Cooley
1-472-17
17 cm / 6 3/4"



Cooley
1-473-17
17 cm / 6 3/4"



Cooley
1-474-17
17 cm / 6 3/4"



Cooley
1-476-17
17 cm / 6 3/4"

Atrauma-Gefaßklemmen

Atrauma Artery Forcep and clamps

Pinzas Clamps Atrauma



Cooley-Derra
1-478-16 - 1-478-18



1-478-16
16 cm / 6 1/4"



1-478-17
17 cm / 6 3/4"



1-478-18
18 cm / 7"



Cooley
1-477-16 = 16 cm / 6 1/4"
1-477-17 = 17 cm / 6 3/4"



1-477-16



1-477-17



Beck
1-479-17
17 cm / 6 3/4"



1/2



Instrumente für Hirnnaht Instruments For Brain suture Instrumentos para sutura cerebral

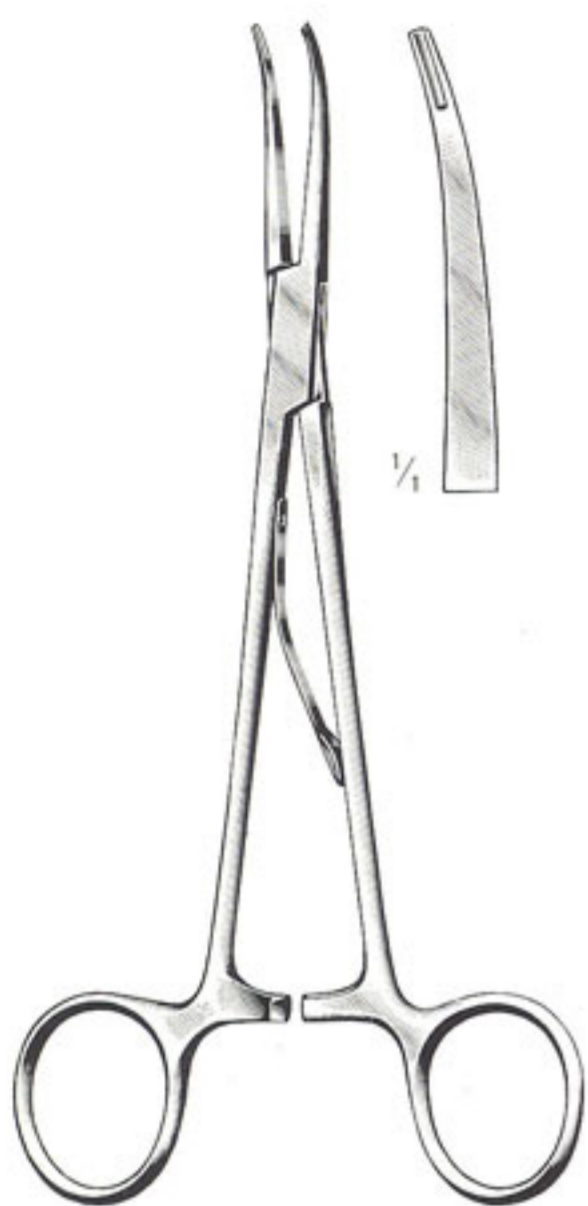

McKenzie
 1-663-15 = 15 cm/6"
 1-663-19 = 19 cm/7 1/2"

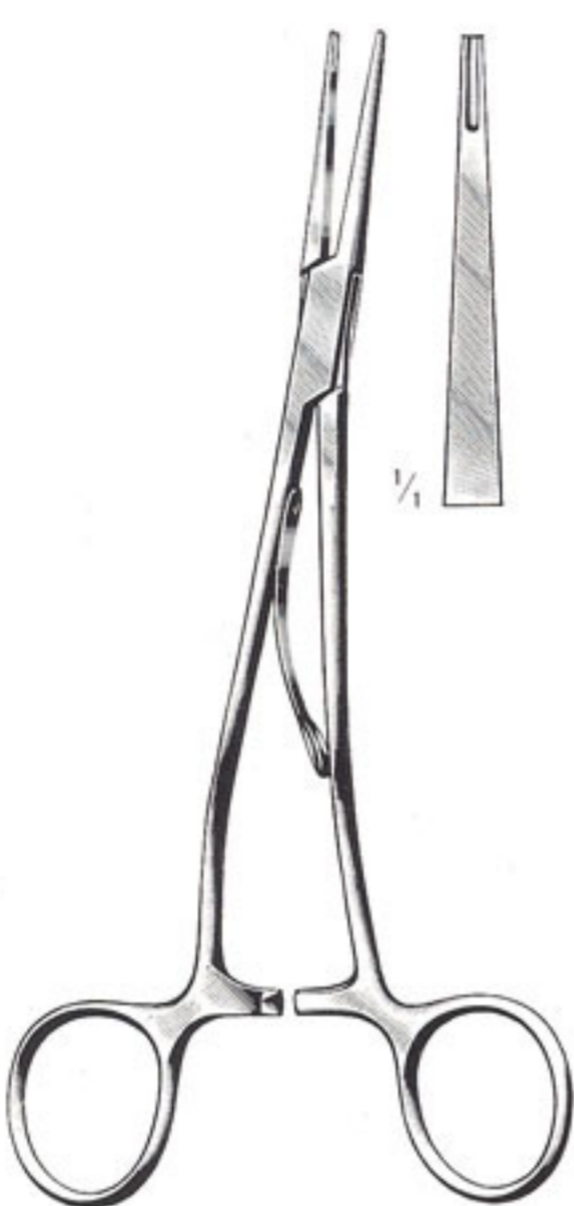

McKenzie
 1-665-15 = 15 cm/6"
 1-665-19 = 19 cm/7 1/2"

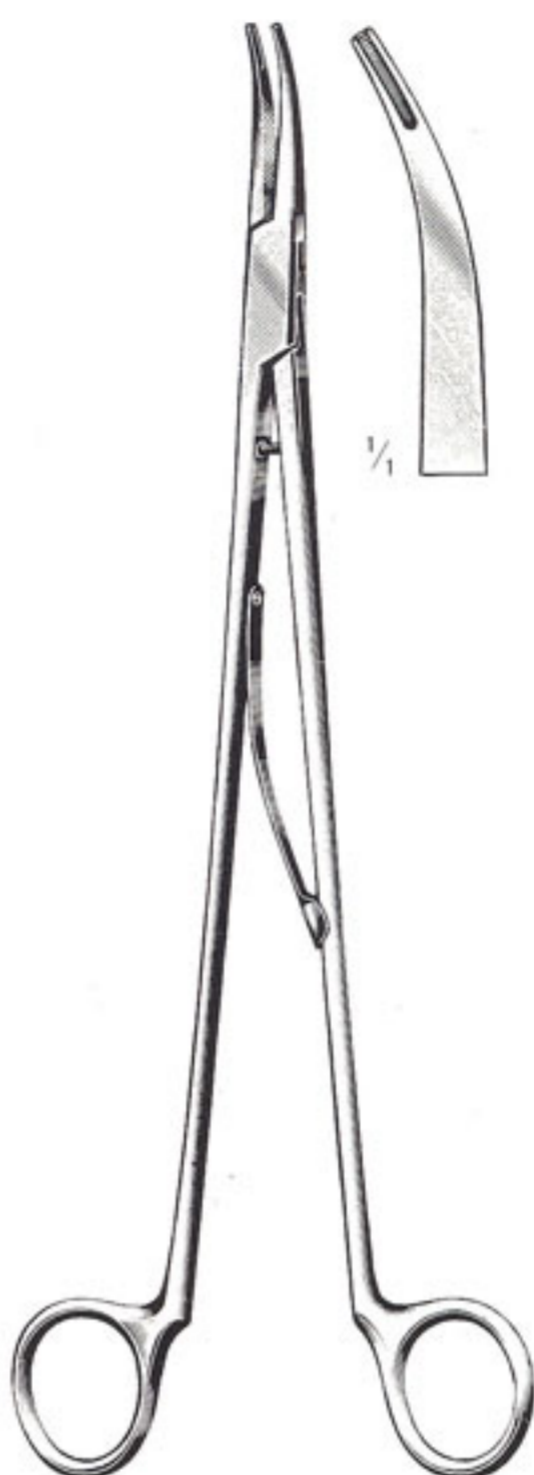

Smithwick
 1-667-23 = 23 cm/9"
 1-667-26 = 26 cm/10 1/4"

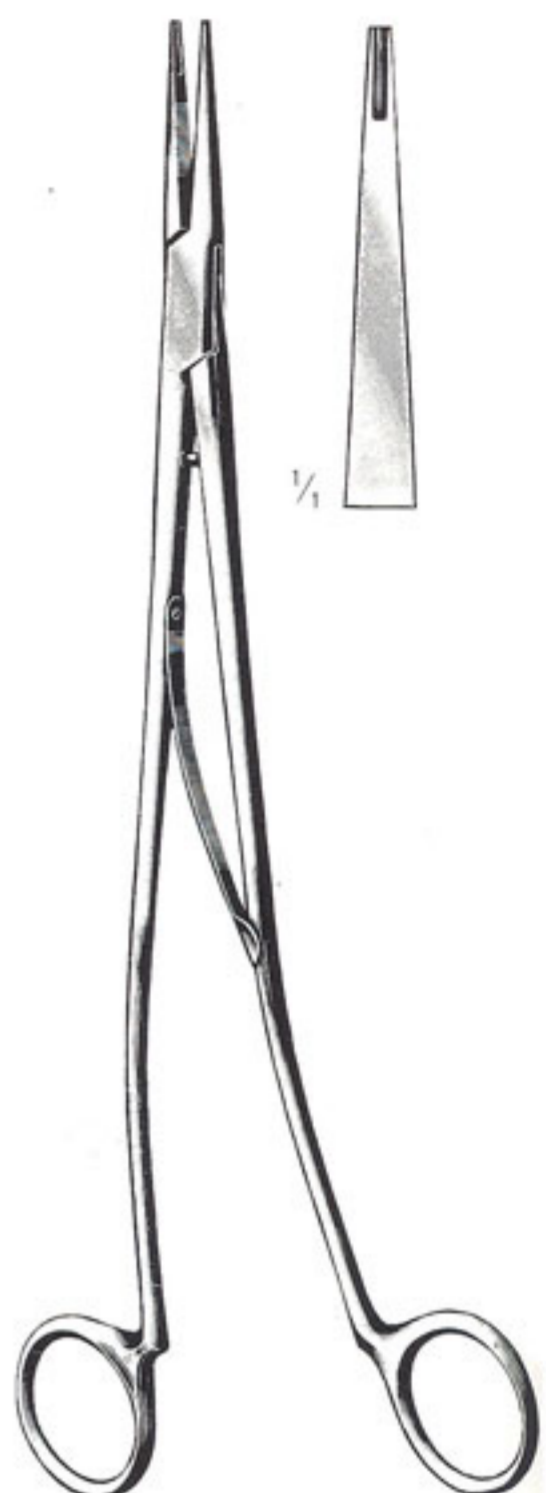

Sweet
 1-669-23 = 23 cm/9"
 1-669-25 = 25 cm/10"



Olivecrona-Toennis
 (Scoville)
 1-661-14

Brain Clip Applying Forceps

- 1-661-14
- 1-663-15 - 1-665-19
- 1-667-23 - 1-669-25

- without ratchet
- with ratchet
- without ratchet

Bone Drills
 see pages 309-314, 330-331
Bone Rongeur Forceps
 see pages 374-379

Dura Dissektoren, Nervseparatoren
 Dura Dissectors, Nerve Separators
 Disecadores para dura-madre, Descoladores de nervios

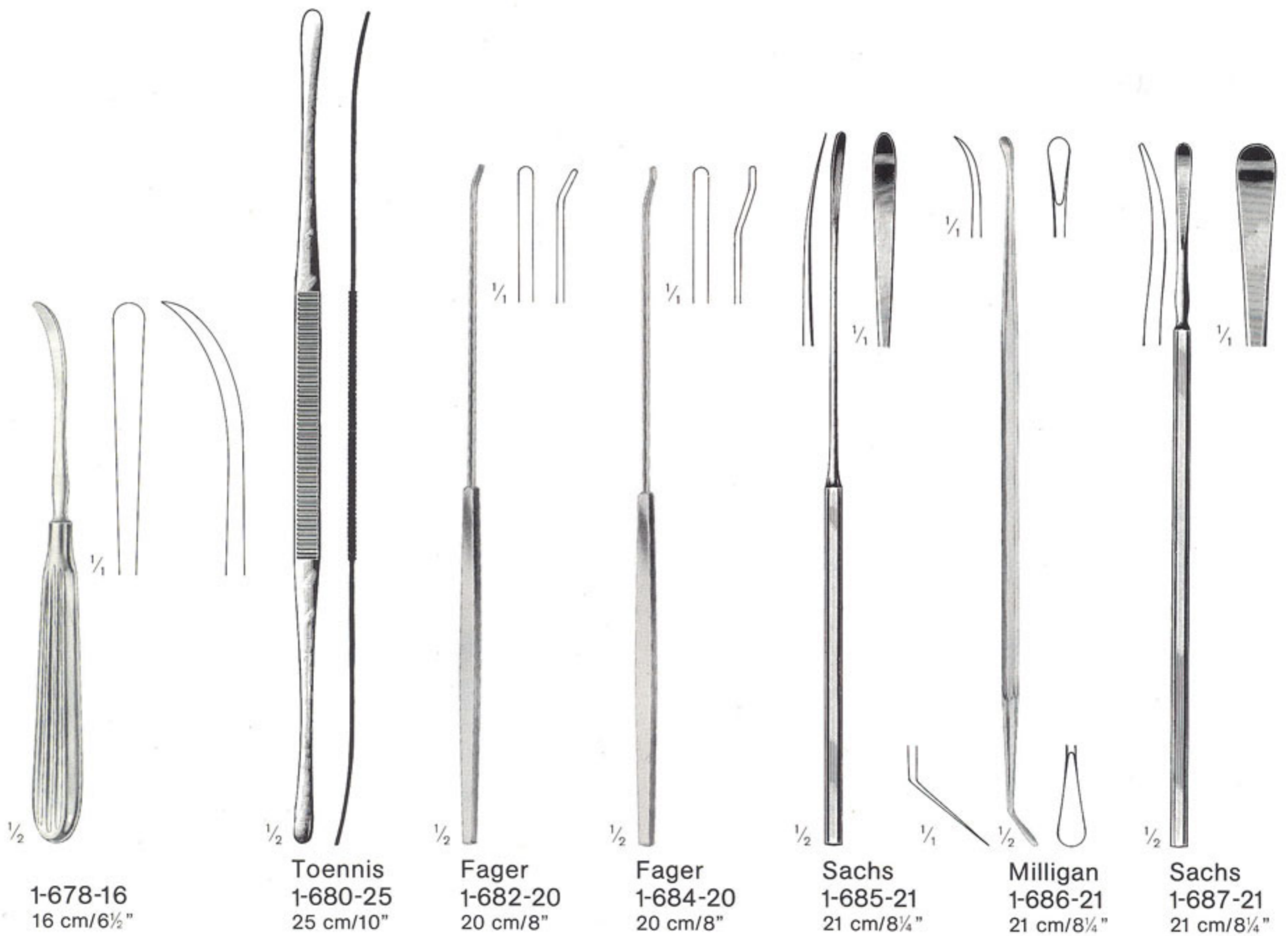

Bandscheibenstanzen

Intervertebral Disc Rongeurs

Pinzas cortantes para discos intervertebrales

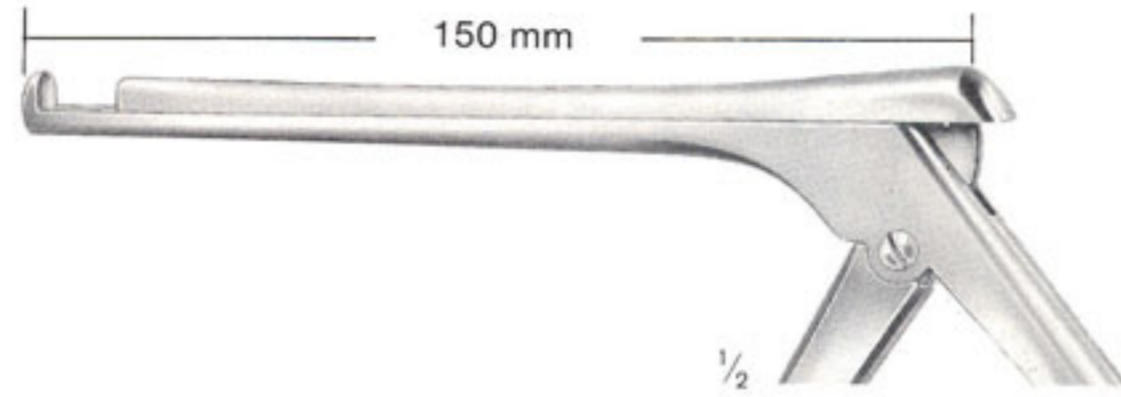

Colclough
1-982-03
1-982-05

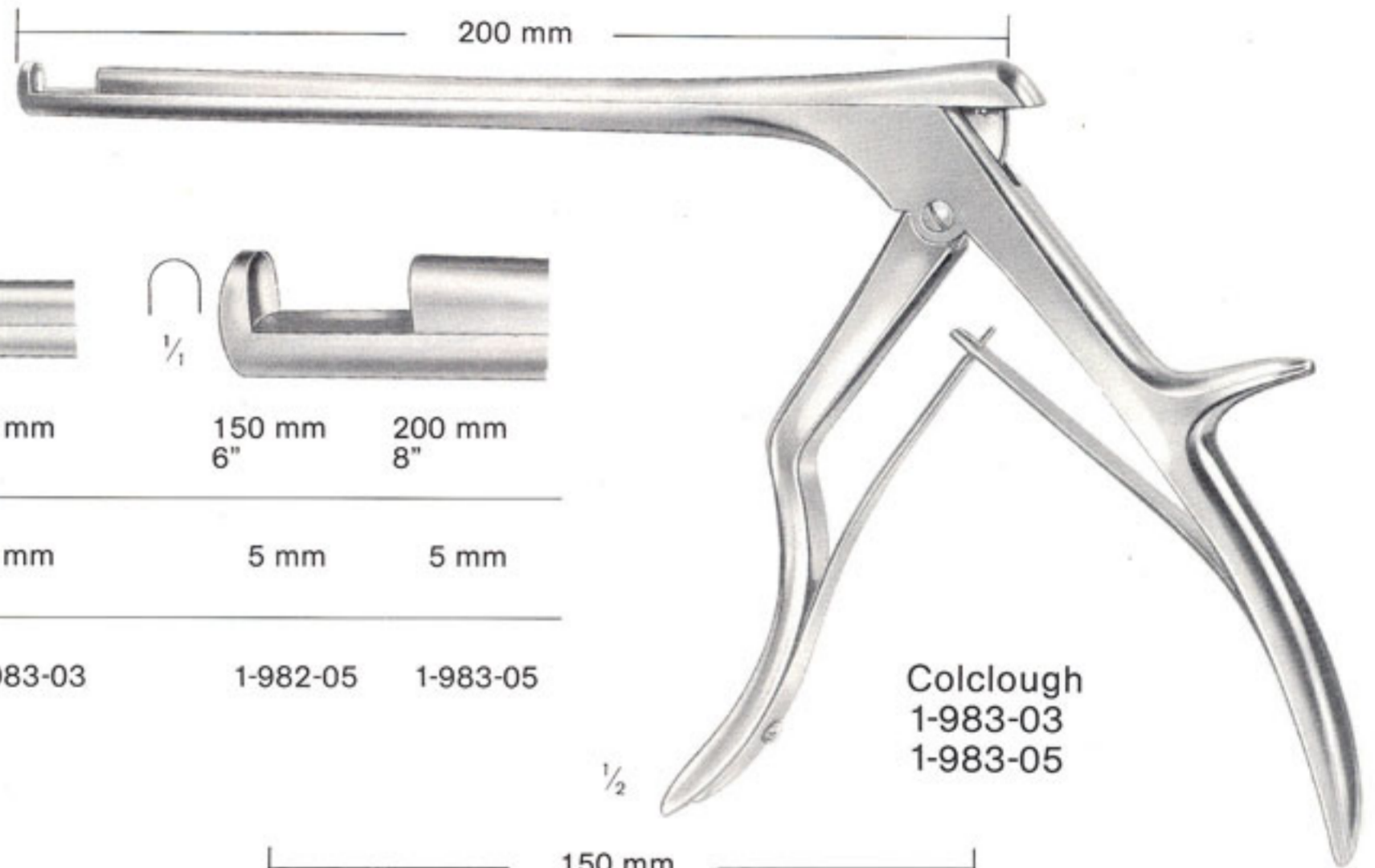

Colclough
1-983-03
1-983-05

Length of shaft	150 mm 6"	200 mm 8"	150 mm 6"	200 mm 8"
Width of bite	3 mm	3 mm	5 mm	5 mm
Cat. Ref.	1-982-03	1-983-03	1-982-05	1-983-05

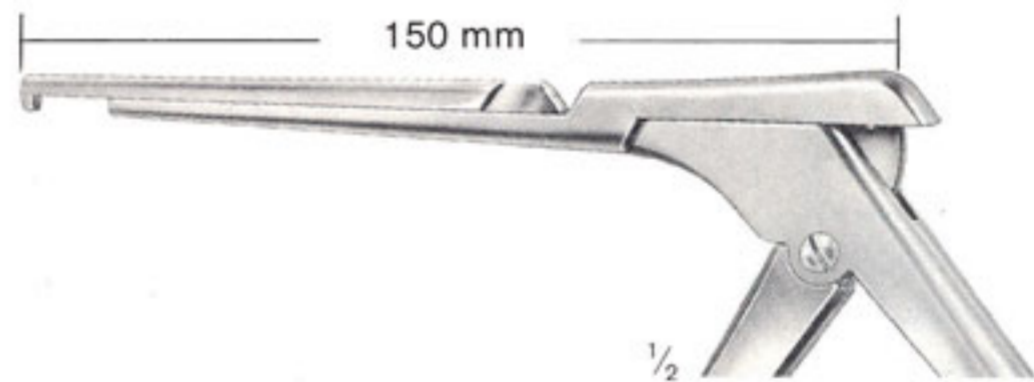

Colclough
1-984-03
1-984-05

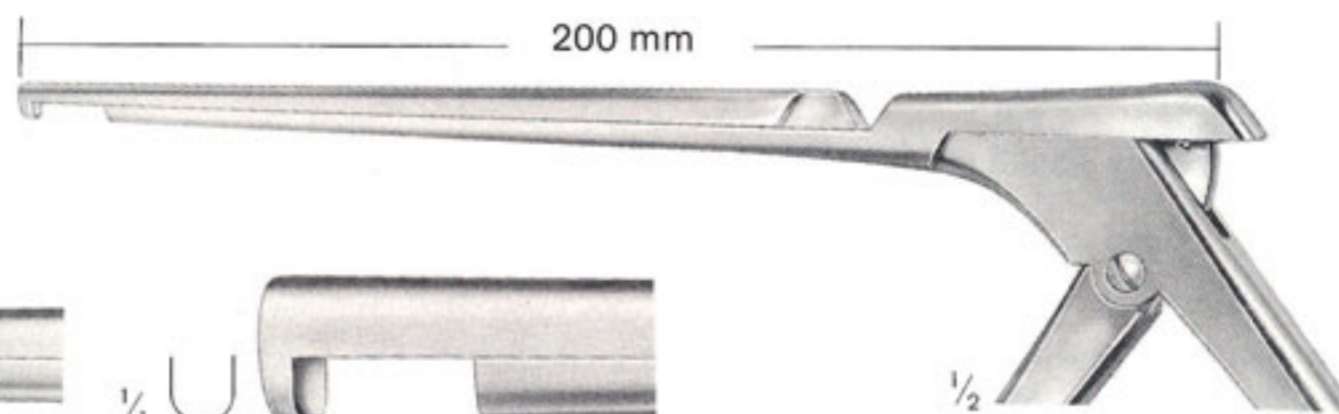

Colclough
1-985-03
1-985-05

Length of shaft	150 mm 6"	200 mm 8"	150 mm 6"	200 mm 8"
Width of bite	3 mm	3 mm	5 mm	5 mm
Cat. Ref.	1-984-03	1-985-03	1-984-05	1-985-05

Laminektomie-Zangen

Laminectomy Rongeurs

Pinzas cortantes para laminectomia

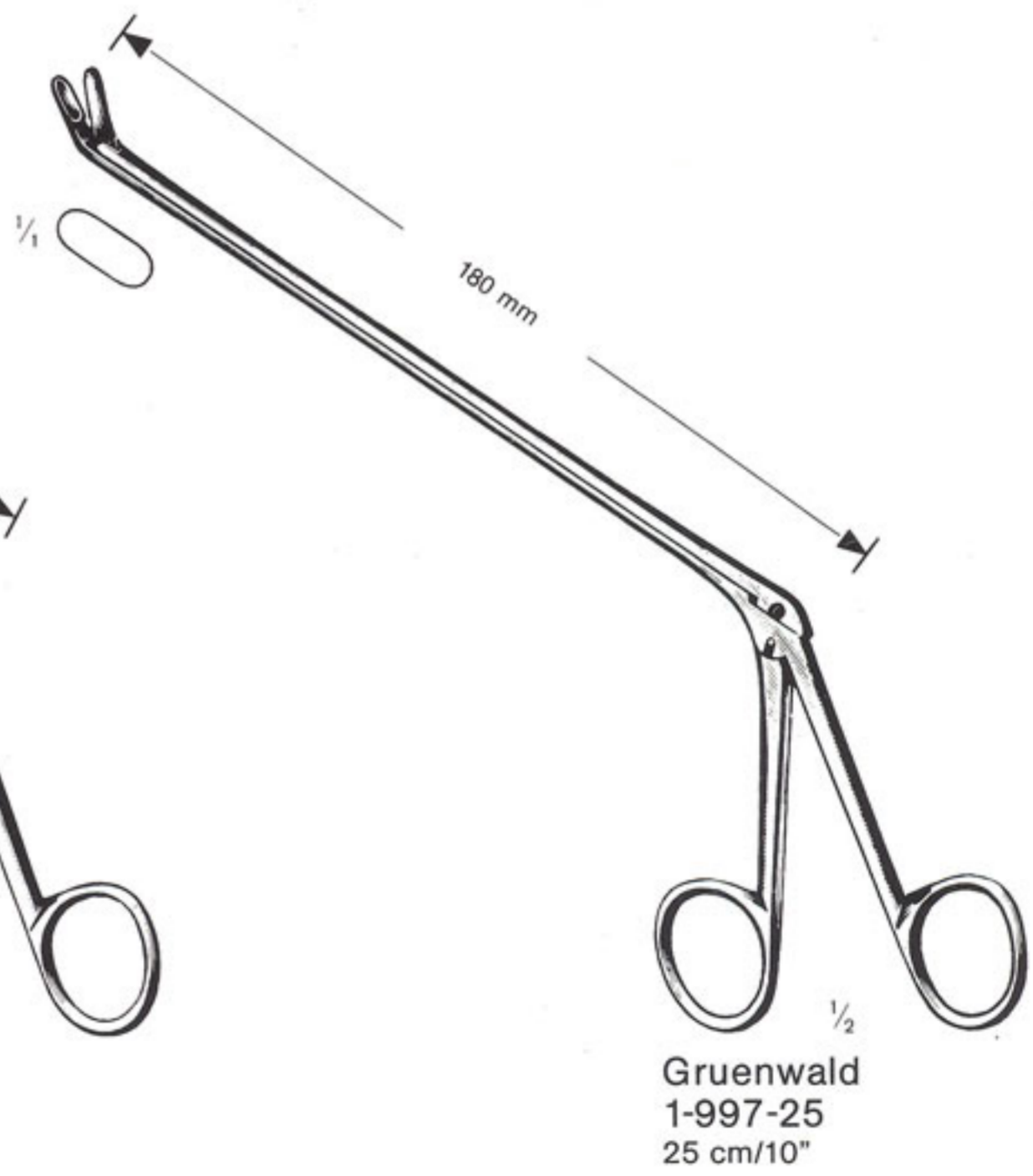
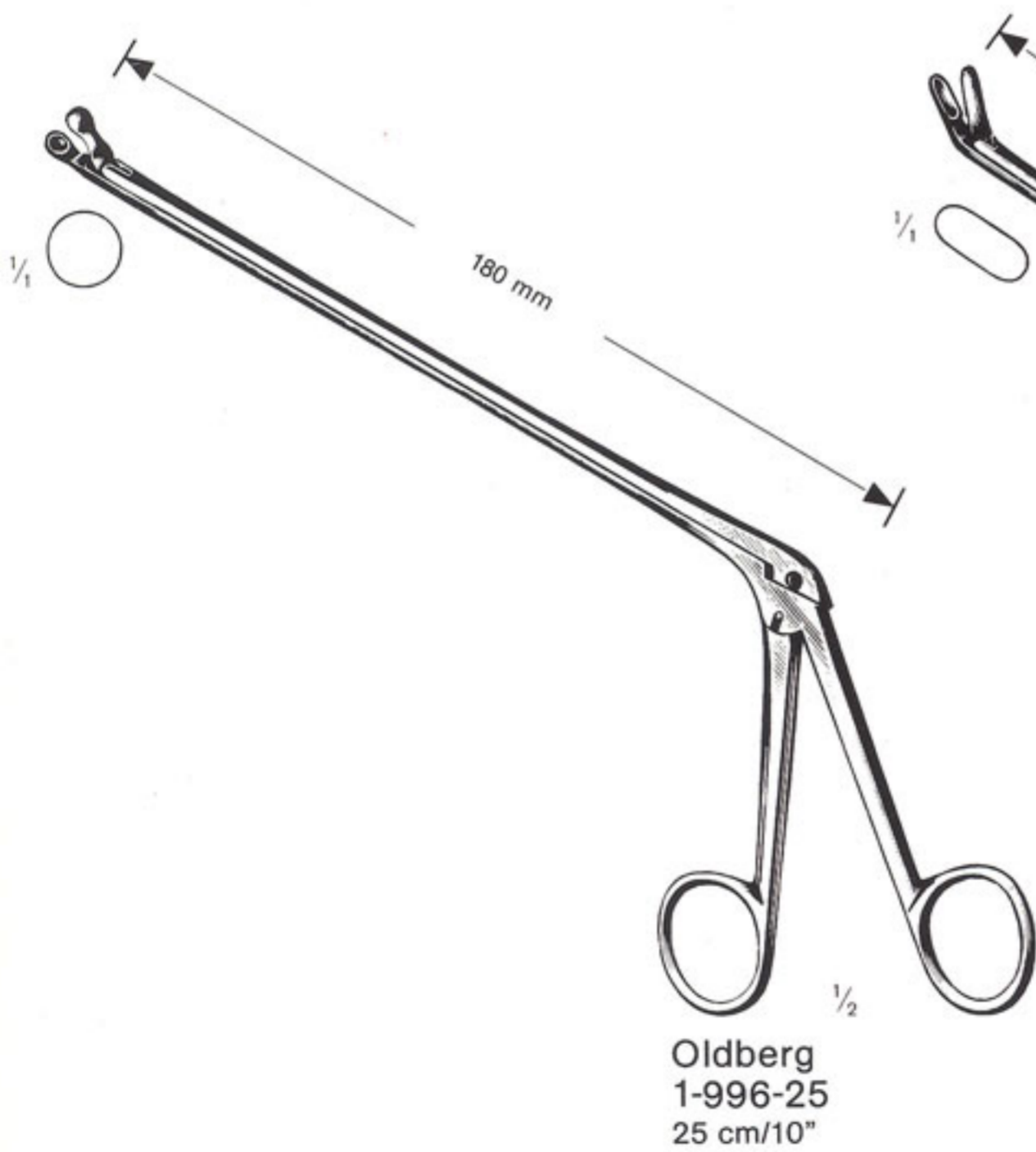
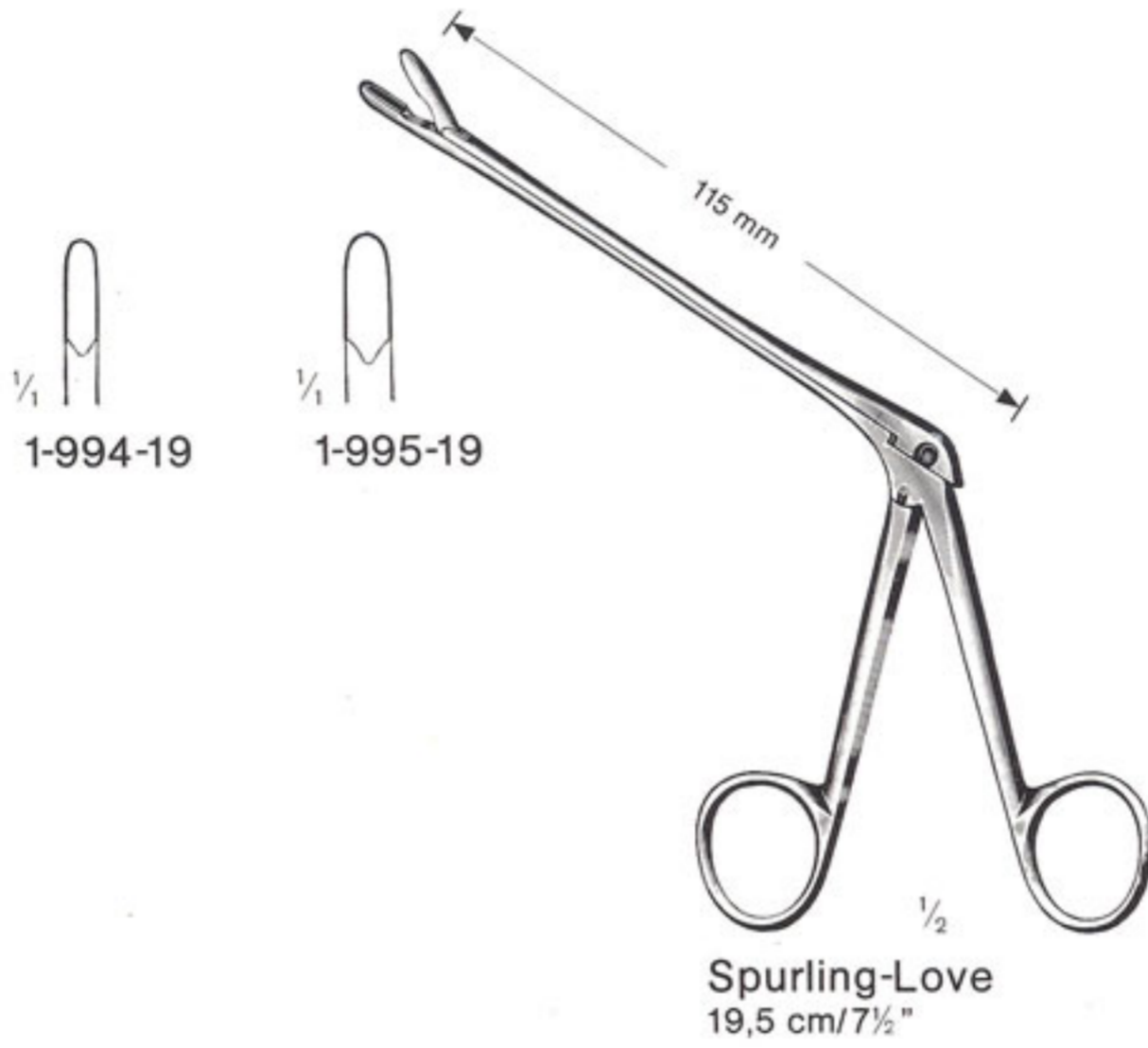

- 1-994-28, 1-995-28 | Laminectomy (Pituitary) Rongeurs, sharp
- 1-996-25 | Laminectomy (Pituitary) Rongeur Forceps, bite 7 mm Ø
- 1-997-25 | ditto, size of bite 3 x 10 mm